

The Crafter panel van Brochure



Commercial
Vehicles

Ready for the toughest jobs.

- Robust design, technologies and driver assistance systems.
- More practical, economical, and innovative than ever before.
- Outstanding in its class.



The perfect workplace.

- Available with an ergoComfort/ergoActive suspension seat*
- A variety of storage solutions with a wide range of different ports and connections
- Available with a heated leather multi-function steering wheel*
- Available with a 230V socket (300w)*

Excellent loadability.

- High load compartment of up to 2,196mm
- Wide side sliding door with an opening width of 1,311mm
- LED load compartment lighting*
- 100mm lower loading sill²
- Up to 18.4m load volume¹

A choice of drive systems.

- Front wheel drive delivers the highest possible load compartment
- The first van to offer an 8-speed automatic gearbox with a choice of front wheel, rear wheel and 4MOTION all-wheel drive

Value for money.

- High residual value
- Low fuel consumption
- Low maintenance costs

Superb connectivity.

- Telematics preparation including FMS 3.0 compatibility*
- Customer-specific function control unit (for special bodies and conversions)*
- Car-Net mobile online services*

Load securing options.

- Available with an optional universal floor*
- Load compartment designed for the addition of flexible shelving systems
- Interior roof rack*
- Up to 14 load-lashing rings

Numerous driver assistance and safety systems.

- The first with City Emergency Braking and Automatic Post-Collision Braking as standard
- Electromechanical Servotronic steering as standard
- Side protection*
- Lane Keeping Assist*
- Rear Traffic Alert*
- Trailer Assist*
- Park Assist*
- LED headlights*

Contents

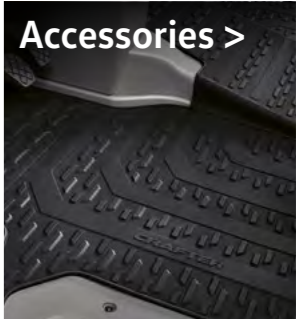
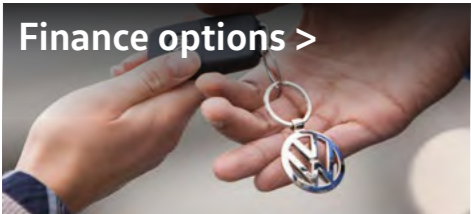

Crafted by you. Engineered by us.



More practical, economical and innovative than ever before. The Crafter panel van is a commercial vehicle like no other. Designed by our customers for our customers. Built from the ground up, using 100% Volkswagen DNA as a cost-effective, transport-oriented solution to meet the demands of a diverse range of businesses. The Crafter panel van represents state-of-the-art manufacturing, with the sole aim of making it the best commercial vehicle in its class.

Illustration includes options at extra charge. Please contact your local Volkswagen Commercial Vehicles Van Centre for details of the standard equipment and optional extras available.

Exterior	Interior	Drive systems	Assistance systems	Crafter panel van	Crafter Bodies & Conversions	Business Pack	Equipment	Model variants	Paint & upholstery	Infotainment & connectivity	Technical information	Price list	Accessories	Finance options	Finance, insurance, servicing & warranties
--------------------------	--------------------------	-------------------------------	------------------------------------	-----------------------------------	--	-------------------------------	---------------------------	--------------------------------	--	---	---------------------------------------	----------------------------	-----------------------------	---------------------------------	--

The perfect workplace. Delivering storage, comfort and technology.



Storage and carrying compartments.

- A Practical open storage compartments, consisting of three separate spaces
- B Multiple sturdy cup holders
- C Largest glovebox in its class
- D Lower dashboard tray with space for longer items
- E Storage in the doors for 1.5 litre bottles, folders and much more. Optional above-cab storage

Ports and connections.

- F Standard USB port for charging mobile devices
- G Standard Bluetooth® connection for mobile phones in conjunction with all radio and navigation devices
- H Multiple 12V sockets. Optional 230V socket for charging tool batteries and laptops (not shown)

Comfort.

- I Optional heated leather multi-function steering wheel
- J Narrow 'A' pillars for improved all-round vision

Illustration includes options at extra charge. Please contact your local Volkswagen Commercial Vehicles Van Centre for details of the standard equipment and optional extras available.



The ergoComfort suspension seat.

- A Suspension seat with weight adjustment
- B Longitudinal seat adjustment
- C Seat height adjustment
- D Seat depth adjustment
- E Seat tilt adjustment
- F Backrest adjustment
- G Electric 4-way lumbar support
- H Headrest adjustment
- I Armrest adjustment

The ergoActive suspension seat.

- J Seat massage function*

* This feature is in addition to the standard features of the ergoComfort seat.

The ergoComfort suspension seats.

Adjustable for a more comfortable driving position.

The optional ergoComfort and ergoActive suspension seats with 20-way adjustment are designed to deliver optimum comfort through the reduction of road-related jolts. The combination of electric and manual adjustment allows the driver to select their preferred seating position. In addition, should you desire, the massage function is also available for the ergoActive suspension seat only.



Two optional large storage compartments in the roof shelf.

A wide range of drive systems.

The Crafter panel van – available with an 8-speed automatic gearbox and a choice of three different drive systems.

The 8-speed automatic transmission is the only one in its class that can be combined with three different drive systems. It has been specially calibrated for the Crafter panel van’s specific driving characteristics, enabling both comfortable and consumption-optimised handling.

Front wheel drive.



100mm lower load sill and entry height.
Highest load height in class.
Highest payload in the range.



Transversely-mounted front engine.



Rear wheel drive.



High towing capacity up to 3.5t.
Gross train weight of up to 8.0t.
Better traction with heavy loads.



Longitudinally-mounted front engine.



4MOTION all-wheel drive.



Dependable traction and control.
Improved directional stability.



Transversely-mounted front engine.



102PS engine	6-speed manual gearbox
122PS engine	-
140PS engine	6-speed manual gearbox or 8-speed automatic gearbox
177PS engine	6-speed manual gearbox or 8-speed automatic gearbox

102PS engine	-
122PS engine	6-speed manual gearbox (only available in combination with twin tyres)
140PS engine	6-speed manual gearbox (only available in combination with single tyres)
177PS engine	6-speed manual gearbox or 8-speed automatic gearbox

102PS engine	-
122PS engine	-
140PS engine	6-speed manual gearbox
177PS engine	6-speed manual gearbox or 8-speed automatic gearbox

Illustrations may include options at extra charge. Please contact your local Volkswagen Commercial Vehicles Van Centre for details of the standard equipment and optional extras available.

Build your own

Find a Tour Centre

Test drive

Offers & Finance

Conversions



State-of-the-art driver assistance and safety systems.

Watch video >



Front Assist with City Emergency Braking System.

Front Assist with City Emergency Braking System.
Standard across the Crafter panel van range, this detects critical distances, warns of hazardous situations and when necessary, triggers emergency braking.¹

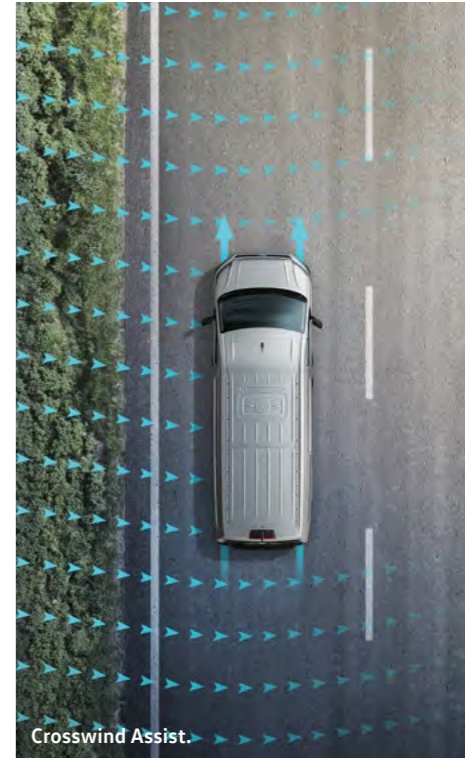

Crosswind Assist.

Crosswind Assist.
As part of the Electronic Stabilisation Programme (ESP), Crosswind Assist applies adaptive braking intervention when the vehicle encounters a strong crosswind. Standard on Crafter panel vans.

¹ For panel van and closed bodies only.

Illustrations may include options at extra charge. Please contact your local Volkswagen Commercial Vehicles Van Centre for details of the standard equipment and optional extras available.

Exterior	Interior	Drive systems	Assistance systems	Crafter panel van	Crafter Bodies & Conversions	Business Pack	Equipment	Model variants	Paint & upholstery	Infotainment & connectivity	Technical information	Price list	Accessories	Finance options	Finance, insurance, servicing & warranties
----------	----------	---------------	---------------------------	-------------------	------------------------------	---------------	-----------	----------------	--------------------	-----------------------------	-----------------------	------------	-------------	-----------------	--

Assistance systems to help keep you one step ahead.

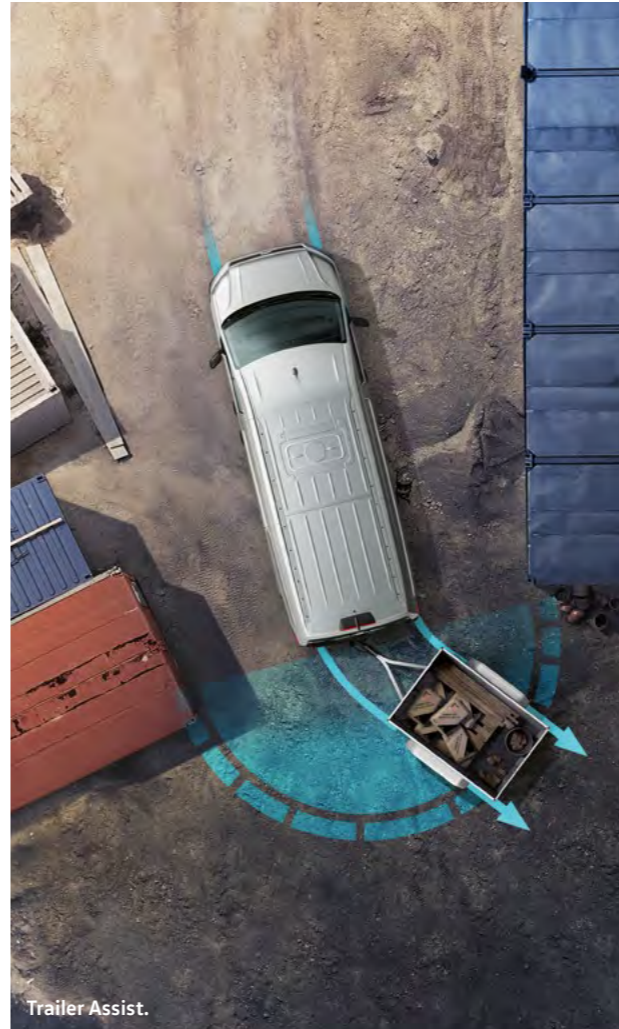
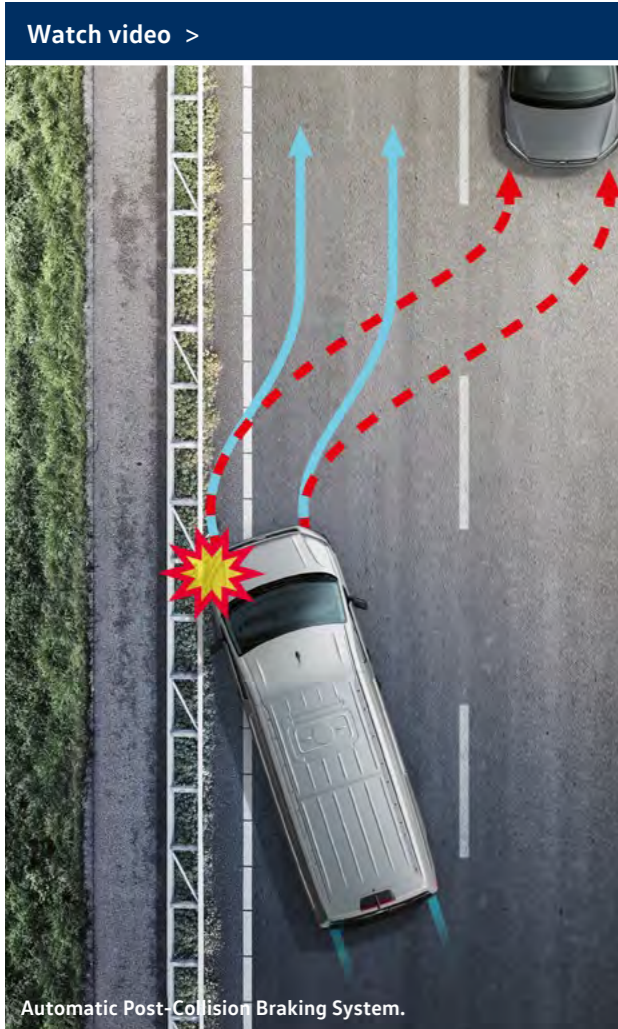

(MCB) Automatic Post-Collision Braking System.
Fitted as standard, the Automatic Post-Collision Braking System triggers braking after a collision, with the aim of preventing secondary collisions.

P Side protection.
Available as an option, Side protection monitors the vehicle's sides and alerts you with visual and audible warnings if you're getting too close to other vehicles, pillars, walls or pedestrians.

P Trailer Assist.
Available as an option, Trailer Assist automatically manoeuvres the vehicle, if fitted with a trailer, during parallel and reverse parking.

Adaptive Cruise Control (ACC).
Available as an option on Trendline only, ACC uses a front radar to measure the distance (up to 120 metres) and speed relative to vehicles driving ahead. It automatically regulates the pre-set distance. ACC also includes the Front Assist with City Emergency Braking System. This detects critical distances, warns of hazardous situations and when necessary, a speed of up to 18mph triggers emergency braking.

Illustrations may include options at extra charge. Please contact your local Volkswagen Commercial Vehicles Van Centre for details of the standard equipment and optional extras available.

Exterior	Interior	Drive systems	Assistance systems	Crafter panel van	Crafter Bodies & Conversions	Business Pack	Equipment	Model variants	Paint & upholstery	Infotainment & connectivity	Technical information	Price list	Accessories	Finance options	Finance, insurance, servicing & warranties
----------	----------	---------------	--------------------	-------------------	------------------------------	---------------	-----------	----------------	--------------------	-----------------------------	-----------------------	------------	-------------	-----------------	--

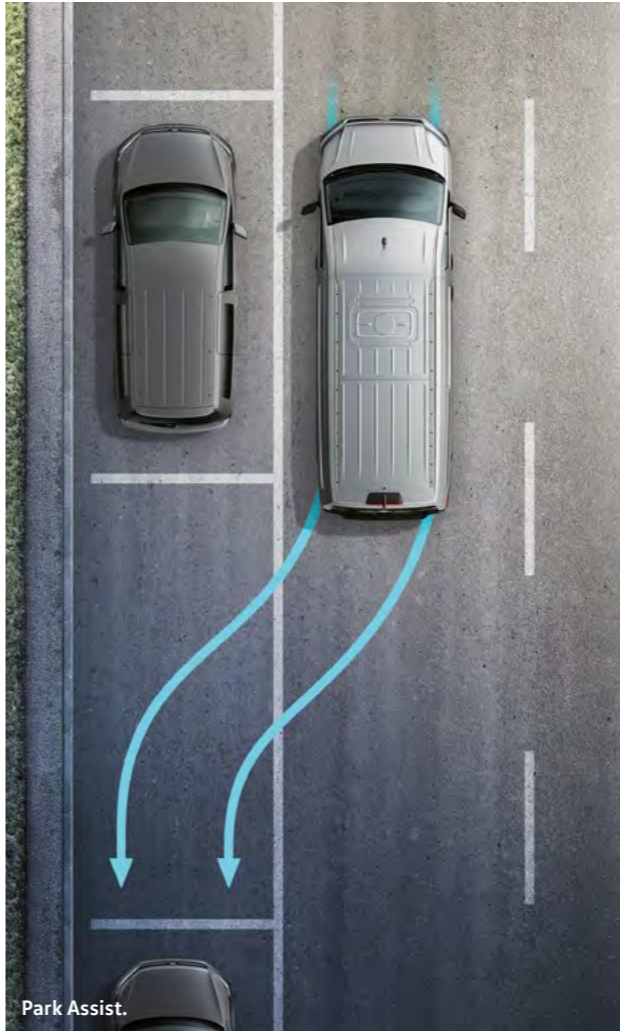
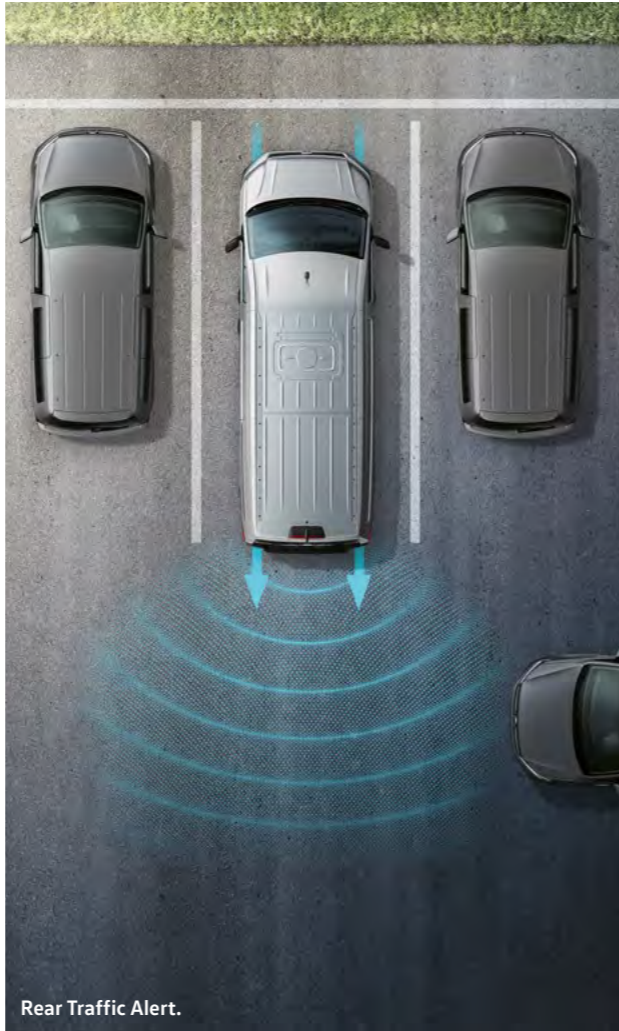
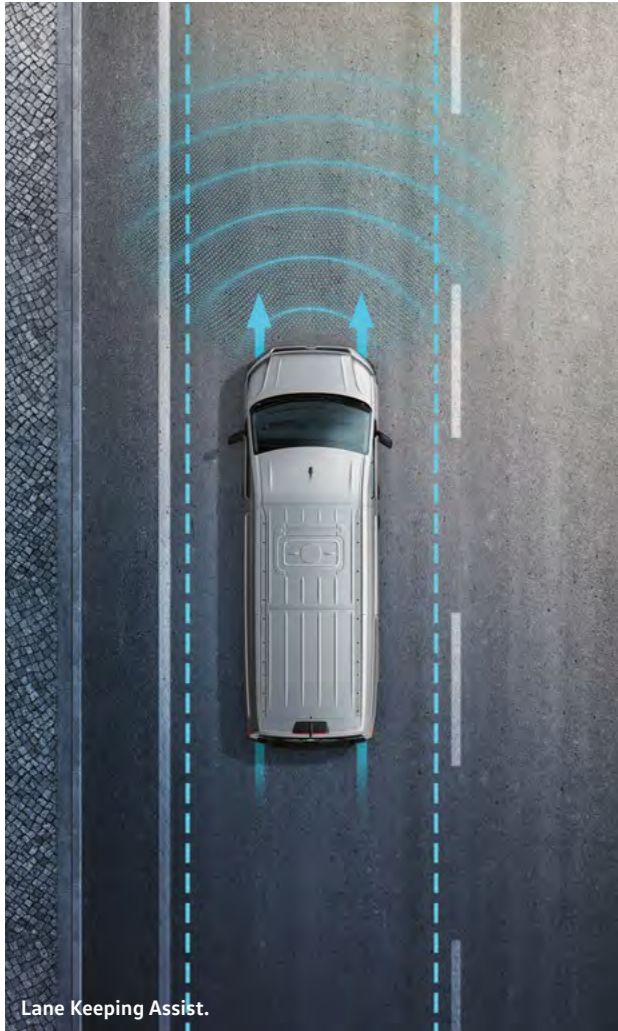

Lane Keeping Assist.¹
 Available as an option, Lane Keeping Assist countersteers the vehicle if the driver unintentionally drifts from a lane. The system also emits audible and visual warnings via the multi-function display to alert the driver of danger.

Rear Traffic Alert.
 Available as an option, Rear Traffic Alert helps by emitting an audible warning when reversing out of a parking space if another vehicle is getting too close. If the driver fails to respond, the system intervenes and applies braking to help avoid a collision.

Park Assist.
 This useful option aids positioning into parking spaces. When reverse is engaged, the vehicle assumes control of the steering. All that's required of the driver is operate the clutch, accelerator and brake pedals, whilst keeping a good lookout.

Light Assist high-beam assistant.
 Automatically dips the headlights when it detects oncoming vehicles, or vehicles travelling ahead, to prevent other drivers from becoming dazzled. The system automatically switches on the high-beam headlights when the vehicle is travelling above 37mph in darkness.

¹ Within the system's thresholds. Illustrations may include options at extra charge. Please contact your local Volkswagen Commercial Vehicles Van Centre for details of the standard equipment and optional extras available.

Exterior	Interior	Drive systems	Assistance systems	Crafter panel van	Crafter Bodies & Conversions	Business Pack	Equipment	Model variants	Paint & upholstery	Infotainment & connectivity	Technical information	Price list	Accessories	Finance options	Finance, insurance, servicing & warranties
----------	----------	---------------	--------------------	-------------------	------------------------------	---------------	-----------	----------------	--------------------	-----------------------------	-----------------------	------------	-------------	-----------------	--



Electromechanical Servotronic steering. Fitted as standard, Electromechanical Servotronic steering provides a speed-sensitive operation with active return. This improves the steering feel around the mid-point, providing improved levels of steering precision.



Electronic Stabilisation Programme (ESP). Fitted as standard, ESP is designed to prevent the vehicle from swerving in critical driving conditions by controlled and targeted intervention in the brakes and engine management system. This helps to maximise directional stability.



Rear-view camera.¹ Simplifies parking by showing a limited view of the area behind the vehicle on the display of the radio or navigation system. Additional guidelines help the driver manoeuvre into the space.



Cruise control. At 18mph and above, the system maintains your chosen preset speed through uphill and downhill inclines. Standard on Trendline and optional on Startline models.



Tyre pressure monitoring system.¹ Displays the current pressure for every tyre and warns of deviations from the set pressure.



Driver Alert System.¹ Uses visual and audible warning signals to recommend that the driver takes a break as soon as it registers driving behaviour that indicates tiredness. Standard on all models.



Road Sign Display.² Detects road signs and informs the driver about the current traffic situation.



Fog lights with cornering function. Ensures optimum visibility in poor weather conditions. The fog light on the inside of the curve illuminates the roadside when turning.



Hill Descent Assist.³ Allows you to descend slopes in a safe, controlled way by regulating the engine speed and applying the brakes as necessary.



Hill Start Assist. This prevents the vehicle from rolling back on inclines, making it easier to start off on uphill slopes. Standard on all models.



Lane Change Assist – Side Scan.¹ Side Scan displays a warning signal on the exterior mirror as soon as one of its sensors detects a vehicle in a blind spot during a lane change.



Anti-lock braking system (ABS).¹ Prevents wheels from locking up and, thus, maintains manoeuvrability. Standard on all models.



Traction control system (ASR). Prevents wheelspin on poor or unstable surfaces.



Electronic differential lock (EDL). Distributes the engine torque to the tyres with the greatest traction.



Driver's airbag. Provides the best possible protection in the event of a frontal impact as a standard feature. A side-head airbag is also available as an option.



Seat belt warning. If their seat belt is not fastened, the seat belt warning reminds the driver to fasten it with a visual warning when the engine is started, and an audible warning after setting off. Standard on all models.



Crafter

¹ Within the system's thresholds. ² Only available in conjunction with the Discover Media navigation system. ³ Only in conjunction with 4MOTION all-wheel drive. Illustration includes options at extra charge. Please contact your local Volkswagen Commercial Vehicles Van Centre for details of the standard equipment and optional extras available.

Exterior	Interior	Drive systems	Assistance systems	Crafter panel van	Crafter Bodies & Conversions	Business Pack	Equipment	Model variants	Paint & upholstery	Infotainment & connectivity	Technical information	Price list	Accessories	Finance options	Finance, insurance, servicing & warranties
----------	----------	---------------	--------------------	-------------------	------------------------------	---------------	-----------	----------------	--------------------	-----------------------------	-----------------------	------------	-------------	-----------------	--

The Crafter panel van

Starting from **£27,220†**

Please click here for more details.

The Crafter panel van is distinguished by having even better loadability and load securing than ever before. The dimensions are ideal for transporting Euro pallets and roll containers. The factory-fitted preparation for shelves and cupboards, the optional universal floor and the optional internal roof rack combine to create even greater flexibility in the load compartment.

Highlights of the Crafter panel van

- Lowest aerodynamic drag in its class
- Largest load compartment height of up to 2,196mm¹
- Largest side loading and opening width of 1,311mm via the sliding door

1 Value applies to the Crafter panel van with long wheelbase Maxi, super-high roof and front-wheel drive.
 2 In comparison to rear-wheel drive and 4MOTION all-wheel drive.

Illustrations may include options at extra charge. Please contact your local Volkswagen Commercial Vehicles Van Centre for details of the standard equipment and optional extras available.



Volkswagen Commercial Vehicles may change RRP's at any time (this includes where there are government changes in regulation and/or legislation). There may be a delay to any RRP displaying correctly on our materials. Always obtain prices from your chosen authorised Van Centre. † Basic RRP excluding VAT.

Exterior	Interior	Drive systems	Assistance systems	Crafter panel van	Crafter Bodies & Conversions	Business Pack	Equipment	Model variants	Paint & upholstery	Infotainment & connectivity	Technical information	Price list	Accessories	Finance options	Finance, insurance, servicing & warranties
----------	----------	---------------	--------------------	--------------------------	------------------------------	---------------	-----------	----------------	--------------------	-----------------------------	-----------------------	------------	-------------	-----------------	--



Innovative load compartments

- Preparation for shelving systems
- Available with a sturdy, hard-wearing beechwood floor
Standard on Trendline and optional on Startline models
- Up to 14 high-strength, retractable load-lashing rings



01 Rear wing doors. The two roof-height doors provide an opening angle of 180°. On Trendline models the standard rear wing doors are extended to an increased opening of 270°. The 270° rear wing doors are available as an option on Startline models.

02 Wooden floor.² This 8mm thick wooden floor for the load compartment provides the optimum surface for your cargo to rest on. Robust beechwood ensures outstanding sturdiness and resilience. Standard on Trendline and optional on Startline models.

03 Universal floor.^{1,2} This wooden floor is the ideal basis for retrofitting the shelving and cupboard systems available from a range of manufacturers. Special adapters (A) enable cupboard systems to be easily fastened using the notches. Longitudinal and transverse load-lashing rails (B) are available as an option for the universal floor.

Storage pockets for the rear wing doors (not shown).¹ The removable storage pockets provide a safe and handy storage option for small tools.

Protective grilles for the rear wing doors (not shown).¹ These protect the rear windows against glass breakage and also help to prevent theft.

Up to 14 load-lashing rings (not shown). The Crafter panel van features two additional load-lashing rings on the partition allowing you to securely fasten cargo with tensioning straps and nets. The adjustable load-lashing rings are recessed to lie flush with the floor. To reduce the risk of being a trip hazard, they can also be folded to the sides in the vicinity of the doors.

Preparation for shelving systems (not shown). There are numerous holes for M6 bolts above and below the window area that simplify installation. The holes are spaced 100mm intervals.

1 Optional at extra cost. 2 Will be introduced at a later date. Illustrations may include options at extra charge. Please contact your local Volkswagen Commercial Vehicles Van Centre for details of the standard equipment and optional extras available.

Easy to load. Loads of space.



Wheelbase. Medium Long Maxi²

Seat configurations
With 2 or 3 seats

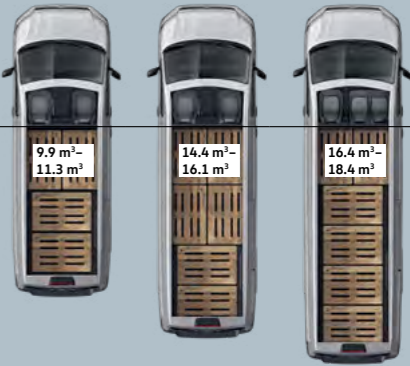

Load compartment⁶
with Eur-1 pallets
800 x 1,200mm

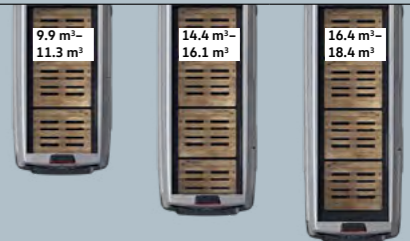

Load compartment⁶
with Eur-3 pallets
1,000 x 1,200mm

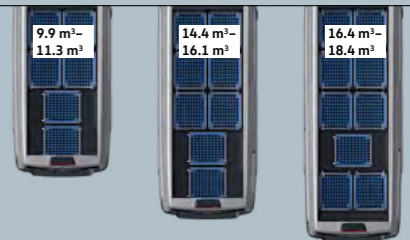

Load compartment⁶
with roll containers
720 x 830mm

Wheelbase	Medium	Long	Maxi ²
Length	3,450mm	4,300mm	4,855mm
Width	1,832mm	1,832mm	1,832mm

Side sliding door with 1,311mm opening width. Easy to load and unload with common load carriers such as Euro pallets.

High load compartment with up to 2,196mm.⁴ In conjunction with front wheel drive, the Crafter panel van offers a competitive load height for its class.

100mm lower load sill. Compared to the rear wheel drive and 4MOTION all-wheel drive, the front wheel drive further simplifies loading and unloading thanks to its lower load sill.

Universal floor for fitting third-party storage systems.⁵ The optional wooden floor is the ideal base for fitting your choice of storage system from a range of manufacturers. Special adapters for the notches in the floor deliver the flexibility to add or remove items with ease.

Preparation for shelving systems. Numerous hexagonal holes for M6 screw fittings are located every 100mm within the load area, simplifying the mounting of shelves and storage units.

1 With front wheel drive, RWD single rear wheel and 4MOTION all-wheel drive. 2 Not available with a low roof. 3 Not available in conjunction with a super-high roof. 4 Figures based on the front wheel drive Crafter panel van long wheelbase Maxi with super-high roof. 5 Optional at extra cost. 6 Figures are based on low roof to high roof load volumes/load volume for front-wheel drive. Illustrations may include options at extra charge. Please contact your local Volkswagen Commercial Vehicles Van Centre for details of the standard equipment and optional extras available.

The Crafter panel van. Engineered for you.

The Crafter panel van is the perfect basis for specialist conversion due to its robust design. You can find example bodies here, on the following pages and also at www.volkswagen-vans.co.uk/conversions



01 Mobility van. The particularly low entry height and front wheel drive provide the optimal basis for the conversion of the Crafter panel van into a vehicle for persons with reduced mobility. Useful features include linear lift or rear lowering.

02 Emergency services vehicle. The Crafter panel van's versatility, with three lengths and heights as well as front wheel drive, rear wheel drive and 4MOTION all-wheel drive make it the ideal base vehicle for this specialist application.

03 Mobile breakdown assistance van. The large cargo space in the Crafter panel van with high roof is ideal for expansion as a mobile workshop.

Upgrade your Crafter panel van with the discounted Business Pack. Now you can drive away in an upgraded Volkswagen Crafter panel van for less.



The Startline and Trendline Crafter panel van Business Pack includes:

- Anti-theft alarm with interior monitoring, backup horn and towing protection
- Climatic air conditioning system
- Overhead storage with two 1-Din slots and reading light
- Parking sensors, front and rear

Upgrade now for as little as **£1,320 +VAT.**

SAVING UP TO £1,400† FOR YOU AND YOUR BUSINESS

Volkswagen Commercial Vehicles may change RRP's at any time (this includes where there are government changes in regulation and/or legislation). There may be a delay to any RRP displaying correctly on our materials. Always obtain prices from your chosen authorised Van Centre. † Saving against the cost of purchasing individual items. Image shown is for illustrative purposes only. Vehicle shown is not UK specification.

Exterior	Interior	Drive systems	Assistance systems	Crafter panel van	Crafter Bodies & Conversions	Business Pack	Equipment	Model variants	Paint & upholstery	Infotainment & connectivity	Technical information	Price list	Accessories	Finance options	Finance, insurance, servicing & warranties
----------	----------	---------------	--------------------	-------------------	------------------------------	----------------------	-----------	----------------	--------------------	-----------------------------	-----------------------	------------	-------------	-----------------	--

Crafter panel van Startline

Standard equipment

Audio and communications

Composition Audio radio with USB/iPod connection and Bluetooth®

Cab area

- Austin fabric seat covers (Anthracite)
- Dual passenger seat with storage compartment and folding tray in backrest
- Electromechanical Servotronic steering
- Rubber floor covering
- Steering wheel with reach and rake adjustment
- 12V socket

Cargo area

- Full-height steel bulkhead without window
- Rear wing doors without window
- Two load-lashing rings on B-pillar

Exterior

- Manually adjustable door mirrors
- 180° rear wing doors. (270° hinges on LWB Maxi)
- 75 litre fuel tank with lockable cap
- Manual side sliding door passenger's side
- Black unpainted bumpers

Additional equipment – Startline 5.0T GVW models

Exterior

- Double rear wheels
- Rear wheel drive

Illustrations includes options at extra charge.

Safety and security

- Anti-lock Braking System (ABS)
- Automatic hazard lights activation under emergency braking
- Crosswind Assist
- Driver Alert System
- Electronic Brake Assist (EBA)
- Electronic Stabilisation Programme (ESP), load adjusting
- Engine immobiliser
- Front Assist with City Emergency Braking System
- Halogen main headlights with range control and daytime running function
- Parking brake with hill hold control.
- Remote central locking with two remote keys
- Seat belt warning light for driver
- Three-point inertia-reel seatbelts for all seats
- Windscreen wiper with variable intermittent delay and wash-wipe system

Wheels and tyres

- 16" x 6.5J steel wheels
- 205/75 R16 C113/111 low rolling resistance
- Full size steel spare wheel
- Tool kit and jack

Safety and security

- Mandatory speed limiter – 56mph.
- Smart digital tachograph

Starting from **£27,220†**

Please click here for more details.

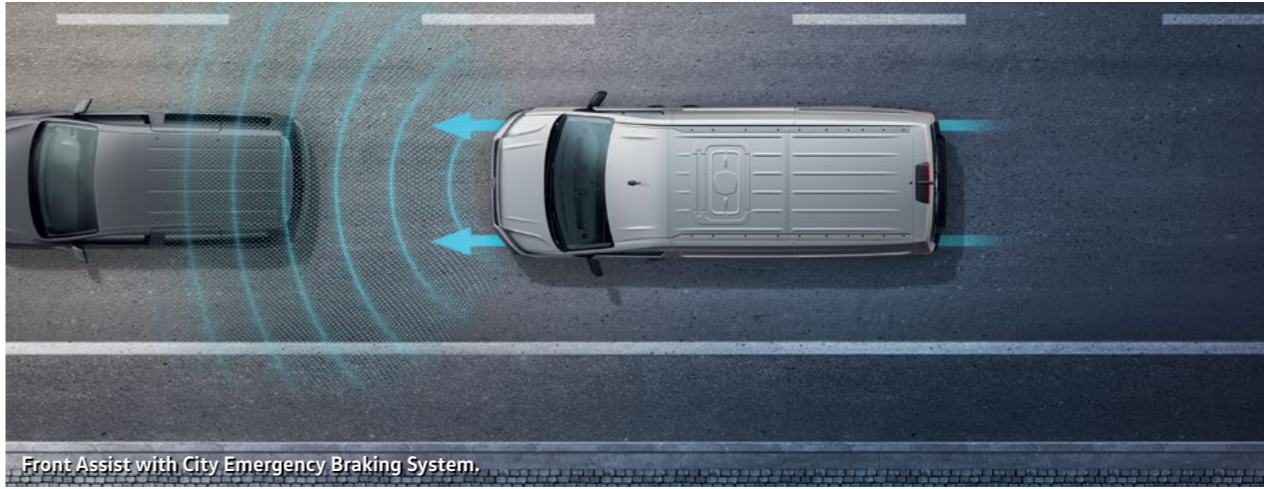

Front Assist with City Emergency Braking System.

Upgrade your Crafter Startline panel van with a Business Pack and save £1,400.*

* Saving against the cost of purchasing individual items.

- Anti-theft alarm with interior monitoring, back-up horn and towing protection
- Climatic air conditioning system
- Overhead storage with two 1-Din slots and reading light
- Parking sensors, front and rear

FOR ONLY

£1,320

+ VAT

Find out more

Volkswagen Commercial Vehicles may change RRP's at any time (this includes where there are government changes in regulation and/or legislation). There may be a delay to any RRP displaying correctly on our materials. Always obtain prices from your chosen authorised Van Centre. † Basic RRP excluding VAT Detailed information regarding tyre efficiency labelling and technical specifications on all potential tyre fitments can be found by visiting the Volkswagen Commercial Vehicles online car configurator at www.volkswagen-vans.co.uk/en/configurator.html

Crafter panel van Trendline

Starting from **£31,530** †

Please click here for more details.

Additional equipment – Trendline

Audio and communications

Composition Colour DAB+ radio with 6.5 inch touch-screen, USB/iPod connection and Bluetooth®
App-Connect

Cab area

Comfort single driver's seat including 2-way lumbar support and armrest
Cruise control with speed limiter
Electrically adjustable and heated door mirrors
Multi-function display Plus
Multi-function steering wheel

Cargo area

Grab handles on rear entry pillars
Load floor cover – wooden

Exterior

Rear wing doors with 270° hinges



Multi-function steering wheel.



Composition Colour DAB+ radio with 6.5 inch touch-screen.

Illustrations may include options at extra charge. Please contact your local Volkswagen Commercial Vehicles Van Centre for details of the standard equipment and optional extras available.

Upgrade your Crafter Trendline panel van with a Business Pack and save £1,400.*

* Saving against the cost of purchasing individual items.

- Anti-theft alarm with interior monitoring, back-up horn and towing protection
- Climatic air conditioning system
- Overhead storage with two 1-Din slots and reading light
- Parking sensors, front and rear

FOR ONLY **£1,320** + VAT
[Find out more](#)









Volkswagen Commercial Vehicles may change RRP at any time (this includes where there are government changes in regulation and/or legislation). There may be a delay to any RRP displaying correctly on our materials. Always obtain prices from your chosen authorised Van Centre. † Basic RRP excluding VAT.



The Crafter panel van model variants.

Panel van

	Medium wheelbase	Long wheelbase	Long wheelbase Maxi
Vehicle length	5,986mm	6,836mm	7,391mm
Interior length	3,450mm	4,300mm	4,855mm
Low roof (optional) Vehicle height ¹ : 2,355mm Interior height ² : 1,726mm		---	---
High roof (standard) Vehicle height ¹ : 2,590mm Interior height ² : 1,961mm			
Super-high roof (optional) Vehicle height ¹ : 2,798mm Interior height ² : 2,196mm	---		

1 For front-wheel drive, 4MOTION all-wheel drive, and rear-wheel drive with single tyres. Height dimensions to the road have a tolerance of ± 50mm. 2 Interior height for front-wheel drive.

Illustrations may include options at extra charge. Please contact your local Volkswagen Commercial Vehicles Van Centre for details of the standard equipment and optional extras available.

Paint & upholstery

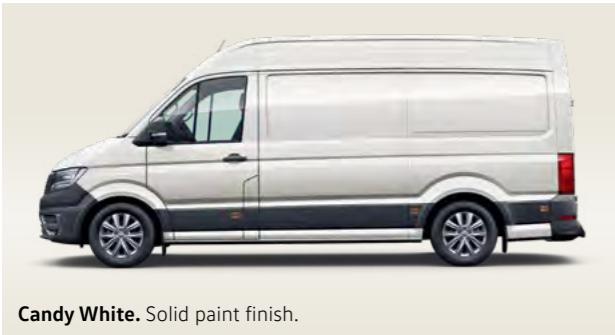

Candy White. Solid paint finish.

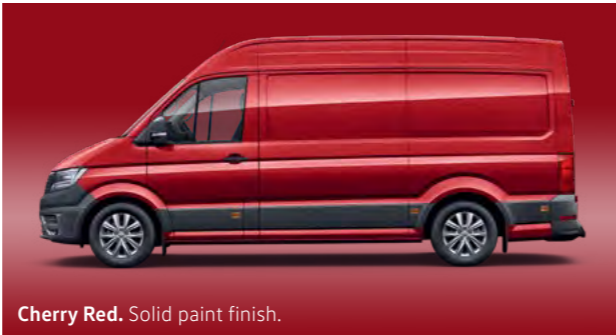

Cherry Red. Solid paint finish.

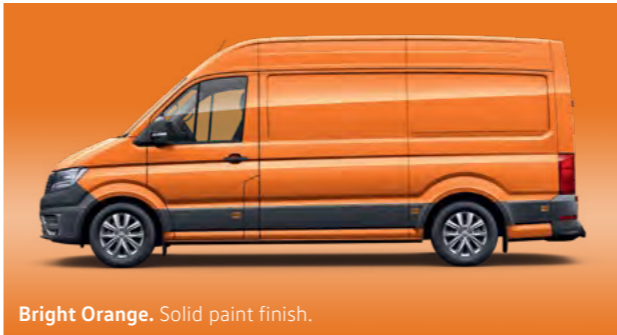

Bright Orange. Solid paint finish.

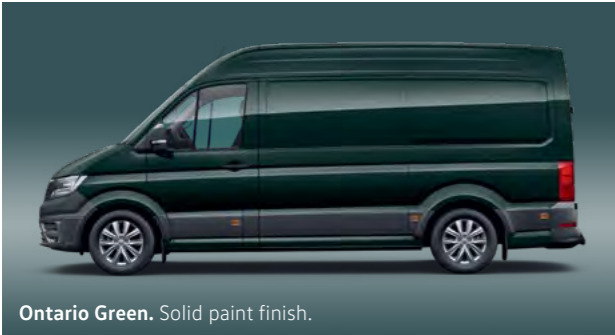

Ontario Green. Solid paint finish.

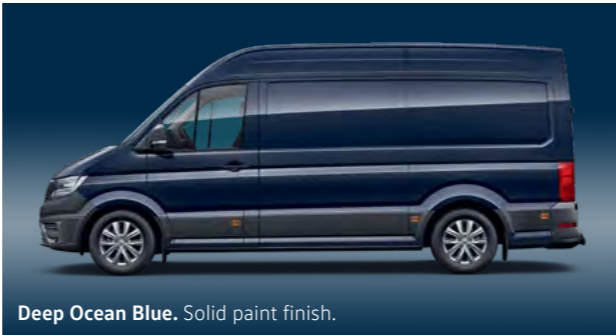

Deep Ocean Blue. Solid paint finish.



Reflex Silver¹. Metallic paint finish.



Indium Grey¹. Metallic paint finish.



Deep Black¹. Pearl Effect paint finish.



Standard Black unpainted front bumper.



Optional body-coloured front bumper.

1 Optional at extra cost.

Please note: Screen representations do not allow exact reproduction of paint and upholstery colours.

Illustrations include options at extra charge. Please contact your local Volkswagen Commercial Vehicles Van Centre for details of the standard equipment and optional extras applicable in your country.

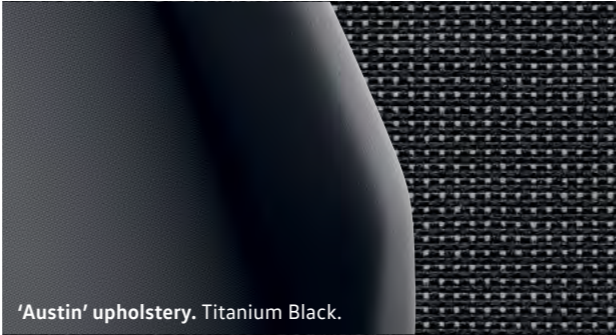

'Austin' upholstery. Titanium Black.

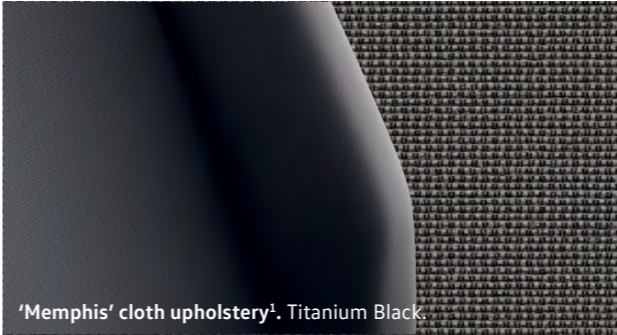

'Memphis' cloth upholstery¹. Titanium Black.



Robust 'Marathon' upholstery¹ Palladium.

Exterior	Interior	Drive systems	Assistance systems	Crafter panel van	Crafter Bodies & Conversions	Business Pack	Equipment	Model variants	Paint & upholstery	Infotainment & connectivity	Technical information	Price list	Accessories	Finance options	Finance, insurance, servicing & warranties
----------	----------	---------------	--------------------	-------------------	------------------------------	---------------	-----------	----------------	-------------------------------	-----------------------------	-----------------------	------------	-------------	-----------------	--

Infotainment & connectivity



01



02



03

01 Composition Audio radio system. The Composition Audio features a 5 inch display and comes with USB and mobile phone interface. Standard on Startline model.

02 Composition Colour DAB+ radio system. The Composition Colour DAB+ radio system features a 6.5 inch TFT touch-screen colour display, two USB (type-C) ports, Bluetooth®, SD card slot and four speakers delivering 20 watt output. It also features App-Connect, an integrated eSIM and mobile online services as part of We Connect¹ and We Connect Plus^{1,2}. Standard on Trendline and optional on Startline models.

03 Discover Media satellite navigation system. The optional Discover Media satellite navigation system features an 8 inch colour touch-screen with proximity sensor. The system also includes DAB+ a 32GB media storage, natural voice control, free map updates via the internet and mobile online services with Volkswagen We Connect Plus^{1,2}, wireless App-Connect³ and integrated eSIM. Optional on all models.

1 To use We Connect services, you need to have a Volkswagen ID user account, and must log into We Connect with your username and password. In addition, a separate We Connect contract or We Connect Plus contract must be concluded online with Volkswagen AG. For We Connect Plus, you have 90 days from the handover of the vehicle to register the vehicle at www.portal.volkswagen-we.com, and use the services for the full duration of the agreed free period. 2 Free of charge for the first year when you order Composition Colour or Discover Media navigation systems. There is an extra charge in the event of renewal once the free period has expired. 3 Only in conjunction with compatible Apple CarPlay devices on the Discover Media navigation system.

We Connect¹ and We Connect Plus^{1,2}

With Volkswagen We Connect¹ driving a van will now be even more digital, closely integrated and comfortable. A wide range of services gives you quick access to the Crafter panel van – conveniently via your smartphone. The heart of the system is the We Connect¹ App. It connects your smartphone to the vehicle with an integrated eSIM card. The standard We Connect¹ package includes various vehicle reports, useful tools for service planning and a breakdown call. Also included: the parking position finder, which guides you directly to the vehicle. You can add many other services with the We Connect Plus^{1,2} package. For example, using your smartphone, the online anti-theft warning system³ immediately sends a message to the mobile phone in the event of burglary attempts, and thanks to online map updates, the map material is always up to date. To take advantage of these exclusive services, you can register today with the We Connect¹ Portal. Once your vehicle has been activated, you can access the full range of Mobile Online Services.



We Connect Plus^{1,2}: Online anti-theft warning system.



Volkswagen App-Connect.

We Connect¹

- Breakdown call
- Information call
- Parking Position
- Automatic Accident Notification
- Vehicle status
- Doors & Lights
- Vehicle Health Report
- Driving Data
- Service Scheduling

We Connect Plus^{1,2}

- Online Traffic Information⁵
- Online POI search
- Online Map Update
- Online Voice Control
- Media Streaming⁴
- Area Alert
- Online anti-theft warning system³
- Speed Alert
- Horn & Turn Signals
- Online Route Calculation
- Filling Stations
- Parking Spaces



We Connect¹: Parking Position.



Mobile telephone interface 'Comfort' including wireless charging function.

¹ To use We Connect services, you need a Volkswagen ID user account and must log in to We Connect with your user name and password. A separate We Connect contract or We Connect Plus contract will also need to be made online with Volkswagen AG. For We Connect Plus you have 90 days after the handover of the vehicle to register the vehicle on www.portal.volkswagen-we.com and can use services free during this time. ² Free of charge for the first year when you order Composition Colour or Discover Media navigation system. There is an extra charge in the event of renewal once the free period has expired. ³ Only in combination with the anti theft alarm system. Optional on all models. ⁴ Only available in conjunction with the Discover Media navigation system and Streaming & Internet package. Optional at extra cost. The scope of services of We Connect and We Connect Plus may vary and can be used at a later date. ⁵ Only in conjunction with the Discover Media navigation systems. Optional at extra cost.

Images shown are for illustrative purposes only. Vehicles shown are not UK specification.

Engine & gearbox data

Engine specifications	2.0 TDI 102PS	2.0 TDI 122PS	2.0 TDI 140PS	2.0 TDI 177PS
Mixture preparation/injection method	Common-rail/exhaust-gas turbocharger	Common-rail/exhaust-gas turbocharger	Common-rail/exhaust-gas turbocharger	Common-rail/exhaust-gas turbocharger
EU exhaust emission standard	Euro 6d-TEMP-EVAP-ISC	Euro 6*	Euro 6d-TEMP-EVAP-ISC	Euro 6d-TEMP-EVAP-ISC*
Number of cylinders	4	4	4	4
Cubic capacity	1,968cc	1,968cc	1,968cc	1,968cc
Output, PS at rpm	102 at 3,000-3,500	122 at 3,500	140 at 3,500-3,600	177 at 3,600
Torque, max. Nm at rpm	300 at 1,400-2,250	300 at 1,400-2,250	340 at 1,600-2,250	410 at 1,500-2,000
Fuel tank capacity	75 litres	75 litres	75 litres	75 litres
AdBlue® tank capacity	18 litres	18 litres	18 litres	18 litres
Diesel Particulate Filter [DPF]	●	●	●	●
6-speed manual gearbox	●	●	●	●
8-speed automatic gearbox	-	-	○	○
Front-wheel drive	●	-	●	●
Rear-wheel drive	-	●	○	○
4MOTION all-wheel drive	-	-	○	○
Alternator ¹	140 A or 180 A	140 A or 180 A	140 A or 180 A	140 A or 180 A
Battery ²	92 Ah or 95 Ah	92 Ah or 95 Ah	92 Ah or 95 Ah	92 Ah or 95 Ah

● Standard ○ Available - Not available. * Please note CR50 models meet Euro 6 standards.

1 Alternator rating depends on trimline and additional optional equipment fitted. 2 Battery rating depends on additional optional equipment fitted.

Panel van fuel consumption, performance and emissions

Engine/transmission		CO ₂ emissions, g/km ¹		Urban mpg (ltr/100km) ¹	Extra-Urban mpg (ltr/100km) ¹	Combined mpg (ltr/100km) ¹	Top speed, mph, (where law permits)
		Max.	Min.				
Startline medium wheelbase with high roof							
CR30	2.0TDI 102PS FWD 6-speed manual	199	199	35.8 (7.9)	38.7 (7.3)	37.2 (7.6)	88
CR35	2.0TDI 102PS FWD 6-speed manual	199	199	35.8 (7.9)	37.8 (7.3)	37.2 (7.6)	88
	2.0TDI 140PS FWD 6-speed manual	203	203	34.4 (8.2)	38.2 (7.4)	36.7 (7.7)	98
	2.0TDI 140PS 4MOTION 6-speed manual	240	240	27.7 (10.2)	32.8 (8.6)	31.0 (9.1)	96
	2.0TDI 140PS FWD 8-speed automatic	194	194	35.3 (8.0)	39.8 (7.1)	38.2 (7.4)	96
	2.0TDI 140PS RWD 6-speed manual	194	194	21.1 (8.0)	18.2 (6.9)	19.4 (7.4)	98
Startline long wheelbase with high roof							
CR35	2.0TDI 102PS FWD 6-speed manual	203	199	35.8 (7.9)	38.7 (7.3)	37.2 (7.6)	88
	2.0TDI 140PS FWD 6-speed manual	205	205	34.4 (8.2)	37.7 (7.5)	36.2 (7.8)	98
	2.0TDI 140PS FWD 8-speed automatic	202	202	33.2 (8.5)	38.7 (7.3)	36.7 (7.7)	96
	2.0TDI 140PS RWD 6-speed manual	194	194	35.3 (8.0)	40.9 (6.9)	38.2 (7.4)	98
CR40	2.0TDI 177PS FWD 6-speed manual	193	193	32.5 (8.7)	43.5 (6.5)	38.7 (7.3)	56
	2.0TDI 177PS FWD 8-speed automatic	204	204	32.1 (8.8)	39.2 (7.2)	36.7 (7.7)	56

¹ These vehicles are WLTP (Worldwide Harmonised Light-Duty Vehicles Test Procedure) type approved vehicles. More information is available at www.volkswagen-vans.co.uk/about-us/wltp. However, to facilitate comparison between different models from different manufacturers and to accommodate the full transition to this new testing regime, we have displayed NEDC figures. These NEDC figures have been derived from WLTP testing, and may not be equivalent to NEDC figures from NEDC testing, so comparisons may be unreliable. Fuel consumption and efficiency figures are provided for comparative purposes only and may not reflect 'real world' driving results. Choice of wheels and other options may affect fuel consumption and emissions data.

Panel van fuel consumption, performance and emissions (continued)

Engine/transmission		CO ₂ emissions, g/km ¹		Urban mpg (ltr/100km) ¹	Extra-Urban mpg (ltr/100km) ¹	Combined mpg (ltr/100km) ¹	Top speed, mph, (where law permits)
		Max.	Min.				
Trendline medium wheelbase with high roof							
CR35	2.0TDI 102PS FWD 6-speed manual	199	199	35.8 (7.9)	38.7 (7.3)	37.2 (7.6)	88
	2.0TDI 140PS FWD 6-speed manual	203	203	34.4 (8.2)	38.2 (7.4)	36.7 (7.7)	98
	2.0TDI 140PS 4MOTION 6-speed manual	240	240	27.7 (10.2)	32.8 (8.6)	31.0 (9.1)	98
	2.0TDI 140PS FWD 8-speed automatic	194	194	35.3 (8.0)	39.8 (7.1)	38.2 (7.4)	98
	2.0TDI 140PS RWD 6-speed manual	194	194	35.3 (8.0)	40.9 (6.9)	38.2 (7.4)	98
	2.0TDI 177PS FWD 6-speed manual	208	206	32.5 (8.7)	38.7 (7.3)	36.2 (7.8)	103
	2.0TDI 177PS 4MOTION 8-speed automatic	245	245	28.0 (10.1)	31.7 (8.9)	30.4 (9.3)	98
	2.0TDI 177PS FWD 8-speed automatic	203	203	34.4 (8.2)	37.2 (7.6)	36.7 (7.7)	103
	2.0TDI 177PS RWD 6-speed manual	207	207	34.0 (8.3)	35.8 (7.9)	35.8 (7.9)	98
Trendline long wheelbase with high roof							
CR35	2.0TDI 102PS FWD 6-speed manual	203	199	35.8 (7.9)	38.7 (7.3)	37.2 (7.6)	88
	2.0TDI 140PS FWD 6-speed manual	205	205	34.4 (8.2)	37.7 (7.5)	36.2 (7.8)	98
	2.0TDI 140PS 4MOTION 6-speed manual	240	240	27.7 (10.2)	32.8 (8.6)	31.0 (9.1)	96
	2.0TDI 140PS FWD 8-speed automatic	202	202	33.2 (8.5)	38.7 (7.3)	36.7 (7.7)	96
	2.0TDI 140PS RWD 6-speed manual	194	194	35.3 (8.0)	40.9 (6.9)	38.2 (7.4)	98
	2.0TDI 177PS FWD 6-speed manual	210	210	31.7 (8.9)	38.2 (7.4)	35.3 (8.0)	103
	2.0TDI 177PS 4MOTION 8-speed automatic	247	247	28.0 (10.1)	31.4 (9.0)	30.1 (9.4)	98
	2.0TDI 177PS FWD 8-speed automatic	209	209	32.8 (8.6)	36.7 (7.7)	35.3 (8.0)	103
	2.0TDI 177PS RWD 6-speed manual	207	207	32.1 (8.8)	38.7 (7.3)	35.8 (7.9)	98
Trendline long wheelbase Maxi with high roof							
CR35	2.0TDI 140PS FWD 6-speed manual	205	205	34.4 (8.2)	37.7 (7.5)	36.2 (7.8)	98
	2.0TDI 140PS FWD 8-speed automatic	205	202	33.2 (8.5)	38.7 (7.3)	36.7 (7.7)	96
	2.0TDI 177PS FWD 6-speed manual	210	210	31.7 (8.9)	38.2 (7.4)	35.3 (8.0)	103

¹ These vehicles are WLTP (Worldwide Harmonised Light-Duty Vehicles Test Procedure) type approved vehicles. More information is available at www.volkswagen-vans.co.uk/about-us/wltp. However, to facilitate comparison between different models from different manufacturers and to accommodate the full transition to this new testing regime, we have displayed NEDC figures. These NEDC figures have been derived from WLTP testing, and may not be equivalent to NEDC figures from NEDC testing, so comparisons may be unreliable. Fuel consumption and efficiency figures are provided for comparative purposes only and may not reflect 'real world' driving results. Choice of wheels and other options may affect fuel consumption and emissions data.

Panel van fuel consumption, performance and emissions (continued)

Engine/transmission		Urban mpg (ltr/100km) ¹	Extra-Urban mpg (ltr/100km) ¹	Combined mpg (ltr/100km) ¹	Top speed, mph (where law permits)	CO ₂ emissions, g/km ¹
Medium wheelbase with high roof						
CR50	2.0TDI 122PS RWD 6-speed manual	26.2 (10.8)	37.7 (7.5)	32.5 (8.7)	56	228
	2.0TDI 177PS RWD 6-speed manual	25.2 (11.2)	38.7 (7.3)	32.5 (8.7)	56	228
	2.0TDI 177PS RWD 8-speed automatic	30.7 (9.2)	35.8 (7.9)	33.6 (8.4)	56	219
Long wheelbase with high roof						
CR50	2.0TDI 122PS RWD 6-speed manual	26.2 (10.8)	37.7 (7.5)	32.5 (8.7)	56	228
	2.0TDI 177PS RWD 6-speed manual	25.2 (11.2)	38.7 (7.3)	32.5 (8.7)	56	228
	2.0TDI 177PS RWD 8-speed automatic	31.4 (9.0)	34.4 (8.2)	33.2 (8.5)	56	222
Long wheelbase Maxi with high roof						
CR50	2.0TDI 122PS RWD 6-speed manual	26.2 (10.8)	36.7 (7.7)	32.1 (8.8)	56	231
	2.0TDI 177PS RWD 6-speed manual	25.0 (11.3)	38.2 (7.4)	32.1 (8.8)	56	231
	2.0TDI 177PS RWD 8-speed automatic	31.4 (9.0)	34.4 (8.2)	33.2 (8.5)	56	222

¹ We are currently changing over to the new vehicle testing regime known as the Worldwide Harmonised Light Vehicle Test Procedure (WLTP). This is being phased in for Light Commercial Vehicles (LCVs) and replaces the New European Driving Cycle (NEDC) test procedure for establishing the official fuel consumption and CO₂ emissions figures for new vehicles. WLTP applies to all vehicle manufacturers. If you order an LCV now, it is likely to have different official fuel consumption, CO₂ emissions data and specification to that shown in the configurator. For more information, please speak to your local authorised Van Centre. Comparisons may be unreliable. Other factors including Gross Vehicle Weight, trimline, extra equipment, options and accessories (wheels, tyres, etc.) may change vehicle parameters such as the weight, rolling resistance of the tyres and the aerodynamics and thus influence the fuel consumption, CO₂ emissions and driving performance values.

Working with you

The Crafter panel van offers professional transport solutions for all: we promise to work with you to tailor your new Crafter panel van and optimise the payload for your individual business requirements. Simply call your local Van Centre directly to discuss your needs.

Panel van weights

Engine/transmission	Gross vehicle weight ¹ , kg	Axle load limit, front/rear, kg	Trailer weight braked 12%/unbraked, kg	Gross train weight, kg	Startline		Trendline		
					Unladen weight ² , kg	Payload ³ , kg	Unladen weight ² , kg	Payload ³ , kg	
Medium wheelbase panel van with high roof									
CR30	2.0TDI 102PS FWD 6-speed manual	3,000	1,800 / 2,100	2,500 / 750	5,500	2,044 - 2,199	801 - 956	-	-
CR35	2.0TDI 102PS FWD 6-speed manual	3,500	1,800 / 2,100	2,500 / 750	5,500	2,044 - 2,199	1,301 - 1,456	2,099 - 2,259	1,241 - 1,401
	2.0TDI 140PS FWD 6-speed manual	3,500	1,800 / 2,100	3,000 / 750	6,000	2,053 - 2,207	1,293 - 1,447	2,108 - 2,268	1,232 - 1,392
	2.0TDI 140PS 4MOTION 6-speed manual	3,500	1,800 / 2,100	3,000 / 750	6,000	2,337	1,163	-	-
	2.0TDI 140PS FWD 8-speed automatic	3,500	1,800 / 2,100	3,000 / 750	6,000	2,239 - 2,092	1,261 - 1,408	2,300 - 2,361	1,200 - 1,403
	2.0TDI 140PS RWD 6-speed manual	3,500	1,800 / 2,100	3,000 / 750	6,500	2,300	1,200	2,361 - 2,245	1,139 - 1,255
	2.0TDI 177PS FWD 8-speed automatic	3,500	1,800 / 2,100	3,000 / 750	6,000	-	-	2,149 - 2,309	1,191 - 1,351
	2.0TDI 177PS RWD 6-speed manual	3,500	1,800 / 2,100	3,500 / 750	7,000	-	-	2,370	1,130
	2.0TDI 177PS 4MOTION 6-speed manual	3,500	1,800 / 2,100	3,000 / 750	6,000	-	-	2,404	1,096
CR50	2.0TDI 177PS 4MOTION 8-speed automatic	3,500	1,800 / 2,100	3,000 / 750	6,000	-	-	2,436	1,064
	2.0TDI 122PS RWD 6-speed manual	5,000	2,200 / 3,500	3,500 / 750	7,500	2,484	2,516	2,575	2,425
	2.0TDI 177PS RWD 6-speed manual	5,000	2,200 / 3,500	3,500 / 750	8,000	-	-	2,428 - 2,585	2,415 - 2,560
	2.0TDI 177PS RWD 8-speed automatic	5,000	2,200 / 3,500	3,500 / 750	8,000	-	-	2,546	2,454

1 We are currently changing over to the new vehicle testing regime known as the Worldwide Harmonised Light Vehicle Test Procedure (WLTP). This is being phased in for Light Commercial Vehicles (LCVs) and replaces the New European Driving Cycle (NEDC) test procedure for establishing the official fuel consumption and CO₂ emissions figures for new vehicles. WLTP applies to all vehicle manufacturers. If you order an LCV now, it is likely to have different official fuel consumption, CO₂ emissions data and specification to that shown in the configurator. For more information, please speak to your local authorised Van Centre. Comparisons may be unreliable.

Other factors including Gross Vehicle Weight, trimline, extra equipment, options and accessories (wheels, tyres, etc.) may change vehicle parameters such as the weight, rolling resistance of the tyres and the aerodynamics and thus influence the fuel consumption, CO₂ emissions and driving performance values.

2 Unladen weight includes approximately 90% fuel load and 75kg for driver.

3 Payload = gross vehicle weight minus unladen weight. Quoted weights are for vehicles with standard specification. Unladen weight and payload may be influenced by trimline, factory options and Van Centre fitted accessories. The minimum payload range includes base specification vehicle. The maximum payload range includes the removal of standard features. Please contact your local Volkswagen Van Centre for more details.

Panel van weights (continued)

Engine/transmission	Gross vehicle weight ¹ , kg	Axle load limit, front/rear, kg	Trailer weight braked 12%/unbraked, kg	Gross train weight, kg	Startline		Trendline		
					Unladen weight ² , kg	Payload ³ , kg	Unladen weight ² , kg	Payload ³ , kg	
Long wheelbase panel van with high roof									
CR35	2.0TDI 102PS FWD 6-speed manual	3,500	1,800 / 2,100	2,500 / 750	5,500	2,174 - 2,304	1,196 - 1,326	2,229 - 2,376	1,124 - 1,271
	2.0TDI 140PS FWD 6-speed manual	3,500	1,800 / 2,100	3,000 / 750	6,000	2,183 - 2,313	1,187 - 1,317	2,238 - 2,385	1,115 - 1,262
	2.0TDI 140PS FWD 8-speed automatic	3,500	1,800 / 2,100	3,000 / 750	6,000	2,345 - 2,224	1,155 - 1,276	2,417 - 2,270	1,083 - 1,230
	2.0TDI 140PS RWD 6-speed manual	3,500	1,800 / 2,250	3,000 / 750	6,500	2,415	1,085	2,487	1,013
	2.0TDI 140PS 4MOTION 6-speed manual	3,500	1,800 / 2,100	3,000 / 750	6,000	-	-	2,512 - 2,374	988 - 1,126
	2.0TDI 177PS FWD 6-speed manual	3,500	1,800 / 2,100	3,000 / 750	6,000	-	-	2,247 - 2,394	1,106 - 1,253
	2.0TDI 177PS FWD 8-speed automatic	3,500	1,800 / 2,100	3,000 / 750	6,000	-	-	2,279 - 2,426	1,074 - 1,221
	2.0TDI 177PS RWD 6-speed manual	3,500	1,800 / 2,250	3,500 / 750	7,000	-	-	2,496 - 2,358	1,004 - 1,142
	2.0TDI 177PS 4MOTION 8-speed automatic	3,500	1,800 / 2,100	3,000 / 750	6,000	-	-	2,415	1,085
CR40	2.0TDI 177PS FWD 6-speed manual	4,000	2,100 / 2,380	2,500 / 750	7,000	2,349	1,651	-	-
	2.0TDI 177PS FWD 8-speed automatic	4,000	2,100 / 2,380	2,500 / 750	7,000	2,381	1,619	-	-
CR50	2.0TDI 122PS RWD 6-speed manual	5,000	2,200 / 3,500	3,500 / 750	7,500	2,634	2,366	2,706	2,294
	2.0TDI 177PS RWD 6-speed manual	5,000	2,200 / 3,500	3,500 / 750	8,000	2,570 - 2,643	2,357 - 2,430	2,583 - 2,715	2,267
	2.0TDI 177PS RWD 8-speed automatic	5,000	2,200 / 3,500	3,500 / 750	8,000	-	-	2,757	2,243
Long wheelbase Maxi with high roof									
CR35	2.0TDI 140PS FWD 6-speed manual	3,500	1,800 / 2,100	3,000 / 750	6,000	-	-	2,296 - 2,459	1,041 - 1,204
	2.0TDI 140PS FWD 8-speed automatic	3,500	1,800 / 2,100	3,000 / 750	6,000	-	-	2,491 - 2,347	1,009 - 1,153
	2.0TDI 177PS FWD 6-speed manual	3,500	1,800 / 2,100	3,000 / 750	6,000	-	-	2,315 - 2,469	1,031 - 1,185
CR50	2.0TDI 122PS RWD 6-speed manual	5,000	2,200 / 3,500	3,500 / 750	7,500	2,704	2,296	2,780	2,220
	2.0TDI 177PS RWD 6-speed manual	5,000	2,200 / 3,500	3,500 / 750	8,000	-	-	2,789	2,211
	2.0TDI 177PS RWD 8-speed automatic	5,000	2,200 / 3,500	3,500 / 750	8,000	-	-	2,757	2,243

1 We are currently changing over to the new vehicle testing regime known as the Worldwide Harmonised Light Vehicle Test Procedure (WLTP). This is being phased in for Light Commercial Vehicles (LCVs) and replaces the New European Driving Cycle (NEDC) test procedure for establishing the official fuel consumption and CO₂ emissions figures for new vehicles. WLTP applies to all vehicle manufacturers. If you order an LCV now, it is likely to have different official fuel consumption, CO₂ emissions data and specification to that shown in the configurator. For more information, please speak to your local authorised Van Centre. Comparisons may be unreliable.

Other factors including Gross Vehicle Weight, trimline, extra equipment, options and accessories (wheels, tyres, etc.) may change vehicle parameters such as the weight, rolling resistance of the tyres and the aerodynamics and thus influence the fuel consumption, CO₂ emissions and driving performance values.

2 Unladen weight includes approximately 90% fuel load and 75kg for driver.

3 Payload = gross vehicle weight minus unladen weight. Quoted weights are for vehicles with standard specification. Unladen weight and payload may be influenced by trimline, factory options and Van Centre fitted accessories. The minimum payload range includes base specification vehicle. The maximum payload range includes the removal of standard features. Please contact your local Volkswagen Van Centre for more details.

Panel van dimensions

CR30/35 medium wheelbase

Roof height		Low ¹ (optional)	High ¹ (standard)
Wheelbase		3,640	3,640
Load compartment	length, mm	3,450/3,201**	3,450/3,201**
	width, mm	1,832	1,832
	width between wheel arches, mm	1,380	1,380
	height, mm (FWD/RWD & 4MOTION)	1,726/1,626	1,961/1,861
	load volume, m ³ (FWD/RWD & 4MOTION)	9.9/9.3	10.7/9.3
Side sliding door	width, mm	1,311	1,311
	height, mm	1,587	1,822
Rear wing doors	width, mm	1,552	1,552
	height, mm	1,605	1,840
Turning circle (wall to wall), m		13.6	13.6

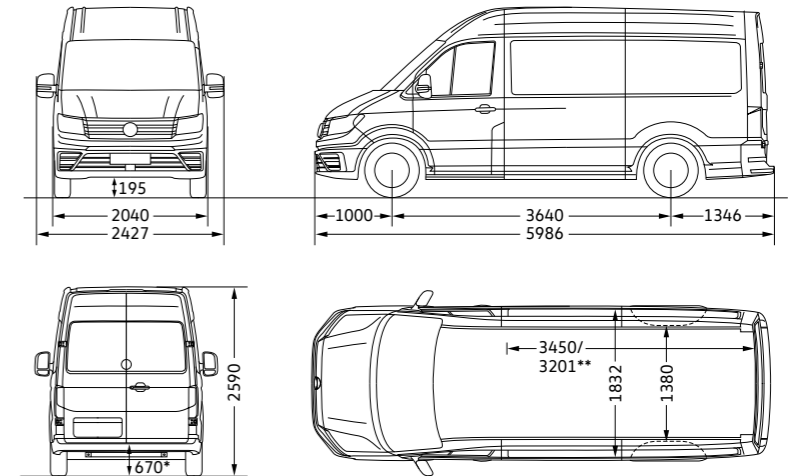

Illustration shown is CR35 medium wheelbase panel van with high roof.
 * This value applies for RWD & 4MOTION all-wheel drive.
 **Load compartment length, max. (at floor level)/load compartment length, min.

All dimensions in millimetres (mm), unless otherwise stated.
 1 CR30 and CR35: RWD & 4MOTION derivatives have a lower internal load height due to a raised floor (by 100mm).

CR35 long wheelbase

Roof height		High ¹ (standard)	Super-high ¹ (optional)
Wheelbase		4,490	4,490
Load compartment	length, mm	4,300/4,051**	4,300/4,051**
	width, mm	1,832	1,832
	width between wheel arches, mm	1,380	1,380
	height, mm (FWD/RWD & 4MOTION)	1,961/1,861	2,189/2,089
	load volume, m ³ (FWD/RWD & 4MOTION)	14.4/13.6	16.1/15.3
Side sliding door	width, mm	1,311	1,311
	height, mm	1,822	1,822
Rear wing doors	width, mm	1,552	1,552
	height, mm	1,840	1,840
Turning circle (wall to wall), m		16.2	16.2

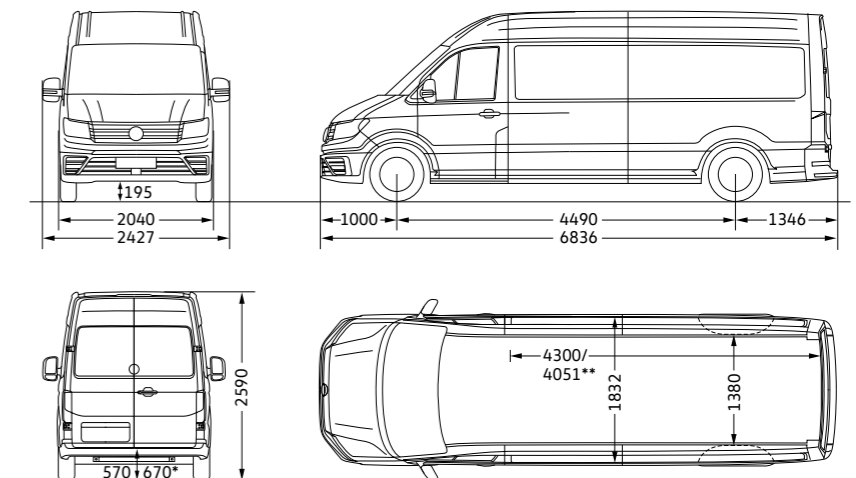

Illustration shown is CR35 long wheelbase panel van with high roof.
 * On high roof models, this value applies for RWD & 4MOTION all-wheel drive and rear-wheel drive.
 On super-high roof models, this value applies for RWD & 4MOTION all-wheel drive only.
 **Load compartment length, max. (at floor level)/load compartment length, min.

All dimensions in millimetres (mm), unless otherwise stated.
 1 CR35: RWD & 4MOTION derivatives have a lower internal load height due to a raised floor (by 100mm).

Please note: all measurements listed are based on series vehicles. The loading sill and height dimensions listed here may vary by approximately ±50 mm depending on the equipment fitted and load. The vehicle drawings are not to scale.

Panel van dimensions (continued)

CR35 long wheelbase Maxi

Roof height		High ¹ (standard)	Super-high ¹ (optional)
Wheelbase		4,490	4,490
Load compartment	length, mm	4,855/4,606**	4,855/4,606**
	width, mm	1,832	1,832
	width between wheel arches, mm	1,380	1,380
	height, mm (FWD/RWD & 4MOTION)	1,961/1,861	2,196/2,096
	load volume, m ³ (FWD/RWD & 4MOTION)	16.4/15.5	18.4/17.5
Side sliding door	width, mm	1,311	1,311
	height, mm	1,822	1,822
Rear wing doors	width, mm	1,552	1,552
	height, mm	1,840	1,840
Turning circle (wall to wall), m		16.2	16.2

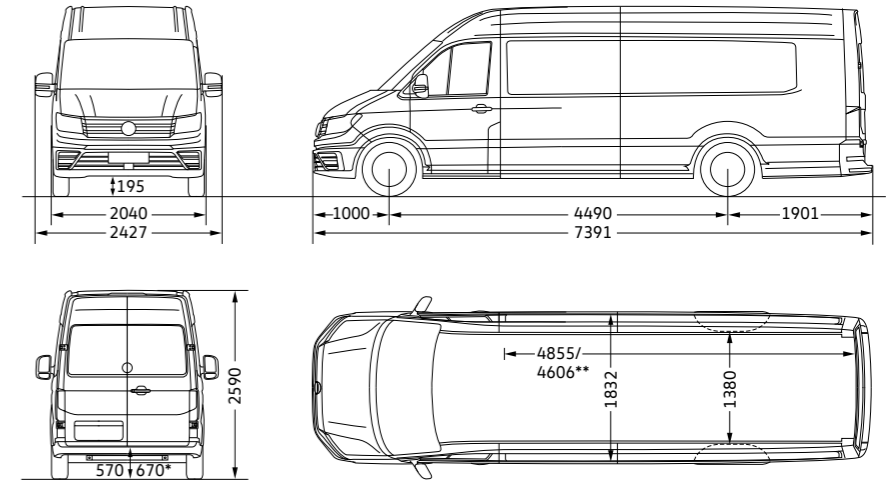

Illustration shown is CR35 long wheelbase Maxi with high roof.
 * This value applies for RWD & 4MOTION all-wheel drive.
 **Load compartment length, max. (at floor level)/load compartment length, min.

All dimensions in millimetres (mm), unless otherwise stated.
 1 CR35: RWD & 4MOTION derivatives have a lower internal load height due to a raised floor (by 100mm).

CR50 medium wheelbase

Roof height		High (standard)
Wheelbase		3,640
Load compartment	length, mm	3,450/3,201*
	width, mm	1,832
	width between wheel arches, mm	1,030
	height, mm	1,861
	load volume, m ³	13.6
Side sliding door	width, mm	1,311
	height, mm	1,722
Rear wing doors	width, mm	1,552
	height, mm	1,740
Turning circle (wall to wall), m		16.2

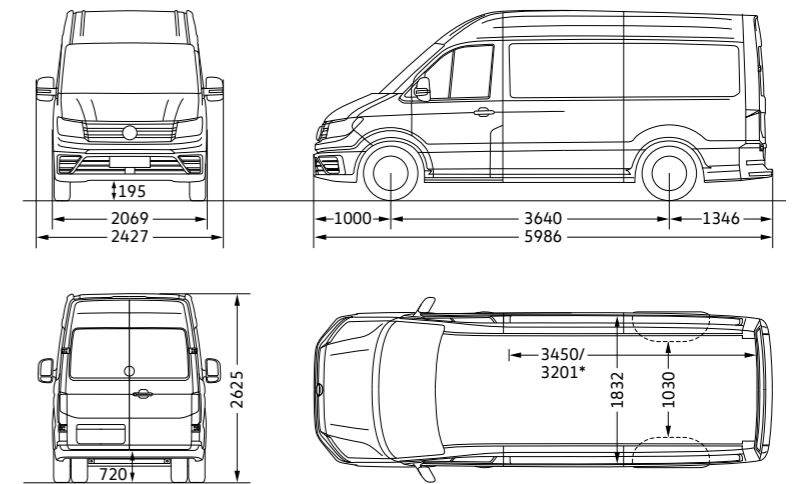

Illustration shown is CR50 medium wheelbase with high roof.
 * Load compartment length, max. (at floor level)/load compartment length, min.

All dimensions in millimetres (mm), unless otherwise stated.

Please note: all measurements listed are based on series vehicles. The loading sill and height dimensions listed here may vary by approximately ±50 mm depending on the equipment fitted and load. The vehicle drawings are not to scale.

Panel van dimensions (continued)

CR50 long wheelbase

Roof height		High (standard)	Super-high (optional)
Wheelbase		4,490	4,490
Load compartment	length, mm	4,300/4,051*	4,300/4,051*
	width, mm	1,832	1,832
	width between wheel arches, mm	1,030	1,030
	height, mm	1,861	2,089
	load volume, m ³	13.6	15.3
Side sliding door	width, mm	1,311	1,311
	height, mm	1,722	1,722
Rear wing doors	width, mm	1,552	1,552
	height, mm	1,740	1,740
Turning circle (wall to wall), m		16.2	16.2

All dimensions in millimetres (mm), unless otherwise stated.

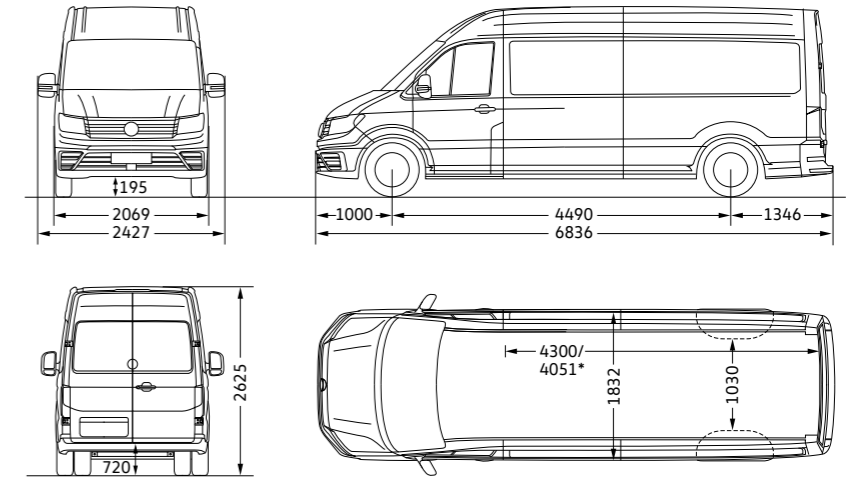

Illustration shown is CR50 long wheelbase with high roof.
* Load compartment length, max. (at floor level)/load compartment length, min.

CR50 long wheelbase Maxi

Roof height		High (standard)	Super-high (optional)
Wheelbase		4,490	4,490
Load compartment	length, mm	4,855/4,606*	4,855/4,606*
	width, mm	1,832	1,832
	width between wheel arches, mm	1,030	1,030
	height, mm	1,861	2,096
	load volume, m ³	15.5	17.5
Side sliding door	width, mm	1,311	1,311
	height, mm	1,722	1,722
Rear wing doors	width, mm	1,552	1,552
	height, mm	1,740	1,740
Turning circle (wall to wall), m		16.2	16.2

All dimensions in millimetres (mm), unless otherwise stated.

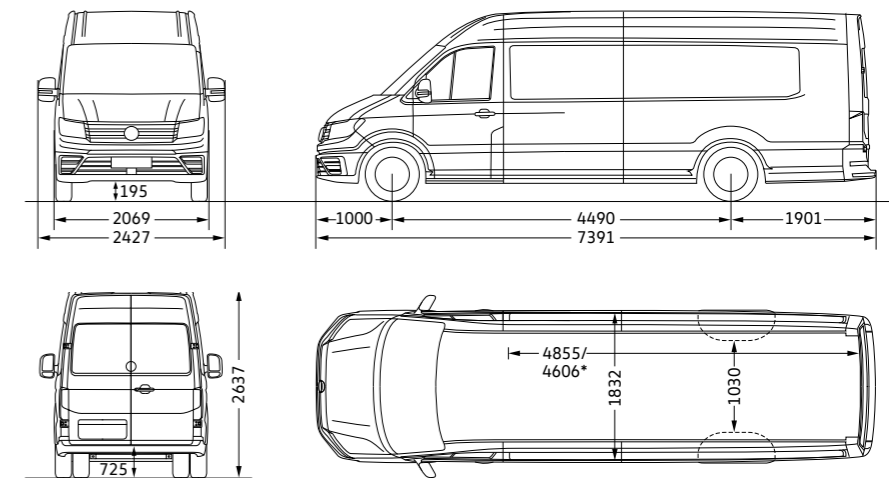

Illustration shown is CR50 long wheelbase Maxi with high roof.
* Load compartment length, max. (at floor level)/load compartment length, min.

Please note: all measurements listed are based on series vehicles. The loading sill and height dimensions listed here may vary by approximately ±50 mm depending on the equipment fitted and load. The vehicle drawings are not to scale.

Model prices



*Manufacturer's on the road (OTR) package

Model	CR30 and CR35	CR50
Delivery to Van Centre	£620.00	£620.00
Number plates	£20.00	£20.00
VAT	£128.00	£128.00
First registration fee	£55.00	£55.00
Vehicle excise duty (VED) 1st year	£275.00	£165.00
Basic OTR price (exc. VAT)	£970.00	£860.00
Total OTR price (inc. VAT)	£1,098.00	£988.00

Volkswagen Commercial Vehicles may change RRP's at any time (this includes where there are government changes in regulation and/or legislation). There may be a delay to any RRP displaying correctly on our materials. Always obtain prices from your chosen authorised Van Centre.

Panel van model prices

Trimline	Engine/transmission/drive system	Basic exc. VAT	Total inc. VAT	Total RRP inc. OTR* exc. VAT	Total RRP inc. OTR* inc. VAT
Startline medium wheelbase with high roof					
CR30	2.0TDI 102PS FWD 6-speed manual	£27,220.00	£32,664.00	£28,190.00	£33,762.00
CR35	2.0TDI 102PS FWD 6-speed manual	£30,045.00	£36,054.00	£31,015.00	£37,152.00
	2.0TDI 140PS FWD 6-speed manual	£31,535.00	£37,842.00	£32,505.00	£38,940.00
	2.0TDI 140PS 4MOTION 6-speed manual	£37,465.00	£44,958.00	£38,435.00	£46,056.00
	2.0TDI 140PS FWD 8-speed automatic	£33,355.00	£40,026.00	£34,325.00	£41,124.00
	2.0TDI 140PS RWD 6-speed manual	£31,980.00	£38,376.00	£32,950.00	£39,474.00
CR50	2.0TDI 122PS RWD 6-speed manual	£34,100.00	£40,920.00	£34,960.00	£41,908.00
Startline long wheelbase with high roof					
CR35	2.0TDI 102PS FWD 6-speed manual	£31,580.00	£37,896.00	£32,550.00	£38,994.00
	2.0TDI 140PS FWD 6-speed manual	£33,070.00	£39,684.00	£34,040.00	£40,782.00
	2.0TDI 140PS FWD 8-speed automatic	£34,890.00	£41,868.00	£35,860.00	£42,966.00
	2.0TDI 140PS RWD 6-speed manual	£33,515.00	£40,218.00	£34,485.00	£41,316.00
CR40	2.0TDI 177PS FWD 6-speed manual	£38,070.00	£45,684.00	£38,930.00	£46,672.00
	2.0TDI 177PS FWD 8-speed automatic	£39,890.00	£47,868.00	£40,750.00	£48,856.00
CR50	2.0TDI 122PS RWD 6-speed manual	£35,635.00	£42,762.00	£36,495.00	£43,750.00
	2.0TDI 177PS RWD 6-speed manual	£38,185.00	£45,822.00	£39,045.00	£46,810.00

* Please [click here](#) for more details on manufacturer's on the road (OTR) package.

Volkswagen Commercial Vehicles may change RRP's at any time (this includes where there are government changes in regulation and/or legislation). There may be a delay to any RRP displaying correctly on our materials. Always obtain prices from your chosen authorised Van Centre.

Panel van model prices (continued)

Trimline	Engine/transmission/drive system	Basic exc. VAT	Total inc. VAT	Total RRP inc. OTR* exc. VAT	Total RRP inc. OTR* inc. VAT
Startline long wheelbase Maxi with high roof					
CR50	2.0TDI 122PS RWD 6-speed manual	£36,545.00	£43,854.00	£37,405.00	£44,842.00
Trendline medium wheelbase with high roof					
CR35	2.0TDI 102PS FWD 6-speed manual	£31,530.00	£37,836.00	£32,500.00	£38,934.00
	2.0TDI 140PS FWD 6-speed manual	£33,020.00	£39,624.00	£33,990.00	£40,722.00
	2.0TDI 140PS FWD 8-speed automatic	£34,840.00	£41,808.00	£35,810.00	£42,906.00
	2.0TDI 140PS RWD 6-speed manual	£33,465.00	£40,158.00	£34,435.00	£41,256.00
	2.0TDI 140PS 4MOTION 6-speed manual	£38,950.00	£46,740.00	£39,920.00	£47,838.00
	2.0TDI 177PS FWD 6-speed manual	£34,860.00	£41,832.00	£35,830.00	£42,930.00
	2.0TDI 177PS FWD 8-speed automatic	£36,680.00	£44,016.00	£37,650.00	£45,114.00
	2.0TDI 177PS RWD 6-speed manual	£35,305.00	£42,366.00	£36,275.00	£43,464.00
	2.0TDI 177PS 4MOTION 8-speed automatic	£42,610.00	£51,132.00	£43,580.00	£52,230.00
CR50	2.0TDI 177PS RWD 6-speed manual	£38,135.00	£45,762.00	£38,995.00	£46,750.00
	2.0TDI 177PS RWD 8-speed automatic	£39,955.00	£47,946.00	£40,815.00	£48,934.00

* Please [click here](#) for more details on manufacturer's on the road (OTR) package.

Volkswagen Commercial Vehicles may change RRP's at any time (this includes where there are government changes in regulation and/or legislation). There may be a delay to any RRP displaying correctly on our materials. Always obtain prices from your chosen authorised Van Centre.

Panel van model prices (continued)

Trimline	Engine/transmission/drive system	Basic exc. VAT	Total inc. VAT	Total RRP inc. OTR* exc. VAT	Total RRP inc. OTR* inc. VAT
Trendline long wheelbase with high roof					
CR35	2.0TDI 102PS FWD 6-speed manual	£33,065.00	£39,678.00	£34,035.00	£40,776.00
	2.0TDI 140PS FWD 6-speed manual	£34,555.00	£41,466.00	£35,525.00	£42,564.00
	2.0TDI 140PS FWD 8-speed automatic	£36,375.00	£43,650.00	£37,345.00	£44,748.00
	2.0TDI 140PS RWD 6-speed manual	£35,000.00	£42,000.00	£35,970.00	£43,098.00
	2.0TDI 140PS 4MOTION 6-speed manual	£40,485.00	£48,582.00	£41,455.00	£49,680.00
	2.0TDI 177PS FWD 6-speed manual	£36,395.00	£43,674.00	£37,365.00	£44,772.00
	2.0TDI 177PS FWD 8-speed automatic	£38,215.00	£45,858.00	£39,185.00	£46,956.00
	2.0TDI 177PS RWD 6-speed manual	£36,840.00	£44,208.00	£37,810.00	£45,306.00
	2.0TDI 177PS 4MOTION 8-speed automatic	£44,145.00	£52,974.00	£45,115.00	£54,072.00
CR50	2.0TDI 177PS RWD 6-speed manual	£39,670.00	£47,604.00	£40,530.00	£48,592.00
	2.0TDI 177PS RWD 8-speed automatic	£41,490.00	£49,788.00	£42,350.00	£50,776.00
Trendline long wheelbase Maxi with high roof					
CR35	2.0TDI 140PS FWD 6-speed manual	£35,465.00	£42,558.00	£36,435.00	£43,656.00
	2.0TDI 140PS FWD 8-speed automatic	£37,285.00	£44,742.00	£38,255.00	£45,840.00
	2.0TDI 177PS FWD 6-speed manual	£37,305.00	£44,766.00	£38,275.00	£45,864.00
CR50	2.0TDI 177PS RWD 6-speed manual	£40,580.00	£48,696.00	£41,440.00	£49,684.00
	2.0TDI 177PS RWD 8-speed automatic	£42,400.00	£50,880.00	£43,260.00	£51,868.00

* Please [click here](#) for more details on manufacturer's on the road (OTR) package.

Volkswagen Commercial Vehicles may change RRP's at any time (this includes where there are government changes in regulation and/or legislation). There may be a delay to any RRP displaying correctly on our materials. Always obtain prices from your chosen authorised Van Centre.

Panel van options

Paint	PR Code	Van	Startline		Trendline	
			Basic exc. VAT	Total RRP inc. VAT	Basic exc. VAT	Total RRP inc. VAT
Solid. Bright Orange (E3E3/2JB) ¹ , Candy White (B4B4), Cherry Red (4B4B), Deep Ocean (OPOP), Ontario Green (V7V7).	As shown	Panel van	○	○	○	○
Metallic. Indium Grey (X3X3), Reflex Silver (8E8E).	As shown	Panel van	£1,160.00	£1,392.00	£1,160.00	£1,392.00
Pearl effect. Deep Black (2T2T).	As shown	Panel van	£1,255.00	£1,506.00	£1,255.00	£1,506.00
Customised. Please contact your local Van Centre for availability.	-	Panel van	From £130.00	From £156.00	From £130.00	From £156.00
Interior trim						
Seat trim covers in Austin fabric. Seats in Titanium Black/dashboard upper-lower in Titanium Black-Palladium/flooring in Pearl Grey.	NOL/AS	Panel van	●	●	●	●
Seat trim covers in Memphis fabric. Seats in Titanium Black/dashboard upper-lower in Titanium Black-Palladium/flooring in Pearl Grey.	N2C/AS	Panel van	£25.00	£30.00	£25.00	£30.00
Seat trim covers in Leatherette – Mesh. Seats in Palladium-Titanium Black/dashboard upper-lower in Titanium Black-Palladium/floor covering in Pearl Grey.	NOC/AL	Panel van	£55.00	£66.00	£55.00	£66.00
Seat trim covers in Robust fabric. Seats in Palladium-Titanium Black/dashboard upper-lower in Titanium Black-Palladium/floor covering in Pearl Grey.	N1C/AL	Panel van	£130.00	£156.00	£130.00	£156.00
Seating						
Basic single driver's seat.	3SH	Panel van	●	●	-	-
Basic single passenger seat.	3TH	Panel van	-£160.00	-£192.00	-	-
Comfort single driver's seat. With longitudinal seat adjustment, adjustable backrest, height adjustment, 2-way lumbar support, an adjustable seat cushion angle and a single armrest on the inner side.	3SE	Panel van	£195.00	£234.00	●	●
Comfort single passenger seat.	3TE	Panel van	-£105.00	-£126.00	-£105.00	-£126.00
Comfort plus single driver's seat. With longitudinal seat adjustment, adjustable backrest, height adjustment, 4-way electronic lumbar support, adjustable seat cushion angle and two armrests.	3SF	Panel van	-	-	£80.00	£96.00
Comfort plus single passenger seat.	3TF	Panel van	-	-	-£55.00	-£66.00
Dual passenger seat in cab. With storage compartment and folding tray in backrest.	3TS	Panel van	●	●	●	●

● Standard - Not available ○ At no extra cost

Where additional equipment is required by chosen options, this will be at additional cost. See the relevant option for recommended pricing or consult your local authorised Van Centre.

1 Bright Orange – this comes without the standard painted trim panel in the bumper.

Volkswagen Commercial Vehicles may change RRP's at any time (this includes where there are government changes in regulation and/or legislation). There may be a delay to any RRP displaying correctly on our materials. Always obtain prices from your chosen authorised Van Centre.

Panel van options (continued)

	PR Code	Van	Startline		Trendline	
			Basic exc. VAT	Total RRP inc. VAT	Basic exc. VAT	Total RRP inc. VAT
Seating (continued)						
ergoComfort driver's seat.	3SP	Panel van	-	-	£330.00	£396.00
ergoComfort passenger seat.	3TP	Panel van	-	-	£220.00	£264.00
ergoActive driver's seat. Including massage function.	3SK	Panel van	-	-	£390.00	£468.00
Heated driver's and front passenger seats.	4A3	Panel van	£330.00	£396.00	£330.00	£396.00
Swivelling driver's seat.	3SD	Panel van	£390.00	£468.00	£205.00	£246.00
Swivelling passenger seat.	3TD	Panel van	£15.00	£18.00	£15.00	£18.00
Wheel and tyre accessories						
All-weather tyres.	VG1	Panel van	£190.00	£228.00	£190.00	£228.00
Lockable wheel bolts.	1PB	Panel van	£25.00	£30.00	£25.00	£30.00
Tyre mobility kit in lieu of spare wheel. Including 12V compressor and tyre sealant.	1G8	Panel van	○	○	○	○
Wheel trims.	1ND	Panel van	£75.00	£90.00	£75.00	£90.00
Audio and communications						
Composition Audio. With 5" display, USB and mobile phone interface.	I7D	Panel van	●	●	-	-
Composition Colour DAB+ with 6.5" touch-screen. USB interface, four speakers (two tweeters and two woofers), multi-function display plus, mobile phone interface, App-Connect and We Connect.	ZI4	Panel van	£495.00	£594.00	●	●
Discover Media navigation system with 8" touch-screen. DAB+, USB interface, four speakers (two tweeters and two woofers), multi-function display plus, mobile phone interface, App-Connect and We Connect preparation.	ZI7	Panel van	£1,095.00	£1,314.00	£750.00	£900.00
Discover Media navigation system including 'Streaming & Internet' with 8" touch-screen. DAB+, USB interface, four speakers (two tweeters and two woofers), multi-function display plus, mobile phone interface, App-Connect and We Connect preparation.	ZIE	Panel van	£1,435.00	£1,722.00	£950.00	£1,140.00
e-Call and We Connect preparation. Only in combination with Overhead storage compartment QE4, Composition Colour radio system ZI4 or Discover Media navigation system ZI7.	R22	Panel van	○	○	-	-

● Standard - Not available ○ At no extra cost

Where additional equipment is required by chosen options, this will be at additional cost. See the relevant option for recommended pricing or consult your local authorised Van Centre.

Detailed information regarding tyre efficiency labelling and technical specifications on all potential tyre fitments can be found by visiting the Volkswagen Commercial Vehicles online car configurator at www.volkswagen-vans.co.uk/en/configurator.html

Volkswagen Commercial Vehicles may change RRP's at any time (this includes where there are government changes in regulation and/or legislation). There may be a delay to any RRP displaying correctly on our materials. Always obtain prices from your chosen authorised Van Centre.

Panel van options (continued)

	PR Code	Van	Startline		Trendline	
			Basic exc. VAT	Total RRP inc. VAT	Basic exc. VAT	Total RRP inc. VAT
Comfort and convenience						
Grab handles on rear entry pillars. A vertical grab handle is installed on the D-pillars on the left and right-hand side of the load/passenger compartment.	7C3	Panel van	£30.00	£36.00	●	●
Glovebox – illuminated with lockable lid.	4Z3	Panel van	●	●	●	●
Heated washer nozzles (windscreen).	9T1	Panel van	£45.00	£54.00	£45.00	£54.00
Overhead cab storage. Accessible from load compartment.	7N4/QE4	Panel van	£145.00	£174.00	£145.00	£174.00
Overhead storage compartment with two 1-DIN slots and reading light.	QE4	Panel van	£135.00	£162.00	£135.00	£162.00
Driver assistance						
Adaptive Cruise Control (ACC). Manual engines only.	8T7	Panel van	-	-	£925.00	£1,110.00
Adaptive Cruise Control (ACC). Automatic engines only.	8T8	Panel van	-	-	£925.00	£1,110.00
Crosswind Assist. As part of the Electronic Stabilisation Programme (ESP), Crosswind Assist applies adaptive braking intervention when the vehicle encounters a strong crosswind.	KJ1	Panel van	●	●	●	●
Cruise control with speed limiter.	8T6	Panel van	£245.00	£294.00	●	●
Driver alert system.	EM1	Panel van	●	●	●	●
Driver assistance pack A. Includes front and rear parking sensors with side protection.	9X0	Panel van	-	-	£875.00	£1,050.00
Driver assistance pack B (with fixed towbar). Includes Trailer Assist, Park Assist and front and rear parking sensors with side protection.	9X3/1D1	Panel van	-	-	£1,870.00	£2,244.00

● Standard - Not available ○ At no extra cost

Where additional equipment is required by chosen options, this will be at additional cost. See the relevant option for recommended pricing or consult your local authorised Van Centre.

Volkswagen Commercial Vehicles may change RRP's at any time (this includes where there are government changes in regulation and/or legislation). There may be a delay to any RRP displaying correctly on our materials. Always obtain prices from your chosen authorised Van Centre.

Panel van options (continued)

	PR Code	Van	Startline		Trendline	
			Basic exc. VAT	Total RRP inc. VAT	Basic exc. VAT	Total RRP inc. VAT
Driver assistance (continued)						
Driver assistance pack B (with removable towbar). Includes Trailer Assist, Park Assist and front and rear parking sensors with side protection.	9X3/1D2	Panel van	-	-	£2,020.00	£2,424.00
Driver assistance pack C. Includes Lane Keeping assist, Lane Change Assist with rear traffic alert.	7Y9	Panel van	-	-	£640.00	£768.00
Driver assistance pack D. Includes Park Assist, front and rear parking sensors with side protection.	9X1	Panel van	-	-	£1,045.00	£1,254.00
Front and rear parking sensors.	7X2	Panel van	£555.00	£666.00	£555.00	£666.00
Front Assist including City Emergency Braking System.	6K2/9S3	Panel van	●	●	●	●
Front fog lights with cornering function.	8WH	Panel van	-	-	£235.00	£282.00
Lane Keeping Assist.	7Y4/9S3	Panel van	-	-	£455.00	£546.00
LED headlights with separate LED daytime running lights.	8IT	Panel van	£955.00	£1,146.00	£955.00	£1,146.00
Leather heated multi-function steering wheel.	2ZW	Panel van	-	-	£285.00	£342.00
Lights & Vision pack A. Includes auto-dimming rear-view mirror, automatic headlights with daytime running lights and windscreen wiper and intermittent control with rain sensor.	ZA3	Panel van	£230.00	£276.00	£230.00	£276.00
Lights & Vision pack B. Includes auto-dimming rear-view mirror, automatic headlights with daytime running lights, windscreen wiper and intermittent control with rain sensor and High Beam Assist.	ZLS	Panel van	£350.00	£420.00	£350.00	£420.00
Preparation for rear-view camera.	KA8	Panel van	-	-	£35.00	£42.00
Rear-view camera. A reversing camera is installed above the third brake light at the rear of the vehicle. The system offers an overview of the traffic situation behind the vehicle and provides a clear view of areas that the driver would otherwise not be able to see.	KA1	Panel van	-	-	£235.00	£282.00
Trailer Assist (with fixed towbar). Trailer Assist automatically manoeuvres the vehicle, if fitted with a trailer, during parallel and reverse parking.	8A6/1D1	Panel van	-	-	£840.00	£1,008.00
Trailer Assist (with removable towbar). Trailer Assist automatically manoeuvres the vehicle, if fitted with a trailer, during parallel and reverse parking.	8A6/1D2	Panel van	-	-	£985.00	£1,182.00

See Business Pack offer.

● Standard - Not available ○ At no extra cost

Where additional equipment is required by chosen options, this will be at additional cost. See the relevant option for recommended pricing or consult your local authorised Van Centre.

Volkswagen Commercial Vehicles may change RRP's at any time (this includes where there are government changes in regulation and/or legislation). There may be a delay to any RRP displaying correctly on our materials. Always obtain prices from your chosen authorised Van Centre.

Panel van options (continued)

Body and chassis	PR Code	Van	Startline		Trendline	
			Basic exc. VAT	Total RRP inc. VAT	Basic exc. VAT	Total RRP inc. VAT
Body-coloured bumpers.	2JF	Panel van	£60.00	£72.00	£60.00	£72.00
Heated windows in rear wing doors.	4HH	Panel van	£285.00	£342.00	£285.00	£342.00
Manual side sliding door driver's side.	5R2	Panel van	£595.00	£714.00	£595.00	£714.00
Manual side sliding door passenger's side.	5Q2	Panel van	●	●	●	●
Mudflaps – front and rear.	6N2	Panel van	£105.00	£126.00	£105.00	£126.00
Rear step in rear bumper full width including side marker lights.	QT4/8F1	Panel van	£215.00	£258.00	£215.00	£258.00
Rear step in rear bumper half width including side marker lights (with fixed towbar).	QT9/1D1/8F1	Panel van MWB	£820.00	£984.00	£820.00	£984.00
		Panel van LWB/LWB Maxi	£725.00	£870.00	£725.00	£870.00
Rear step in rear bumper half width including side marker lights (with removable towbar).	QT9/1D2/8F1	Panel van MWB	£965.00	£1,158.00	£965.00	£1,158.00
		Panel van LWB/LWB Maxi	£880.00	£1,056.00	£880.00	£1,056.00
Rear step in rear bumper half width including side marker lights (with towbar preparation).	QT9/1D8/8F1	Panel van MWB	£710.00	£852.00	£710.00	£852.00
		Panel van LWB/LWB Maxi	£625.00	£750.00	£625.00	£750.00
Rear wash-wipe including rear wing doors with windows.	4HS/ZHF	Panel van	£380.00	£456.00	£380.00	£456.00
Rear wing doors with 270° hinges. Standard on LWB Maxi.	5V4	Panel van	£265.00	£318.00	●	●
Rear wing doors with windows.	ZHF	Panel van	£140.00	£168.00	£140.00	£168.00
Rear wing doors without windows.	3RD	Panel van	●	●	●	●

● Standard – Not available ○ At no extra cost

Where additional equipment is required by chosen options, this will be at additional cost. See the relevant option for recommended pricing or consult your local authorised Van Centre.

Volkswagen Commercial Vehicles may change RRP's at any time (this includes where there are government changes in regulation and/or legislation). There may be a delay to any RRP displaying correctly on our materials. Always obtain prices from your chosen authorised Van Centre.

Panel van options (continued)

Body and chassis (continued)	PR Code	Van	Startline		Trendline	
			Basic exc. VAT	Total RRP inc. VAT	Basic exc. VAT	Total RRP inc. VAT
Roof – low.	3R0	Panel van MWB only	-£430.00	-£516.00	-£430.00	-£516.00
Roof – super high in white.	ZD3	Panel van LWB only	£1,150.00	£1,380.00	£1,150.00	£1,380.00
		Panel van LWB Maxi only	£1,200.00	£1,440.00	£1,200.00	£1,440.00
Roof – super high in body colour exterior only.	2S2/ZD3	Panel van LWB only	£1,600.00	£1,920.00	£1,600.00	£1,920.00
		Panel van LWB Maxi only	£1,810.00	£2,172.00	£1,810.00	£2,172.00
Roof rails (roof length channels for mounting rails).	YBA	Panel van	£265.00	£318.00	£265.00	£318.00
Roof rack – 3 moveable roof bars on the roof rail system (requires YBA roof rails).	YBB	Panel van	£345.00	£414.00	£345.00	£414.00
Side marker lights. Standard on LWB and LWB Maxi.	8F1	Panel van	£85.00	£102.00	£85.00	£102.00
Towbar – fixed.	1D1	Panel van	£600.00	£720.00	£600.00	£720.00
Towbar – preparation with bracket socket and cable.	1D8	Panel van	£495.00	£594.00	£495.00	£594.00
Towbar – preparation including wiring harness and control unit for trailer stabilisation.	1D7	Panel van	£205.00	£246.00	£205.00	£246.00
Wing mirrors – electrically heated and adjustable.	6XN	Panel van	£110.00	£132.00	●	●
Without passenger's side sliding door including manual side sliding door driver's side with interlock.	5Q0/5R1	Panel van	£60.00	£72.00	£60.00	£72.00
Without passenger's side sliding door including manual side sliding door passenger's side.	5Q0/5R2	Panel van	○	○	○	○
Cargo area						
Bulkhead – deleted.	ZT0	Panel van	○	○	○	○
Bulkhead – full height with lining without window.	3CS/3W6	Panel van	£210.00	£252.00	£210.00	£252.00
Bulkhead (steel) – full height without window.	3CF	Panel van	●	●	●	●
All-weather rubber mats in cab.	YSA	Panel van	£55.00	£66.00	£55.00	£66.00
Floor covering, wooden.	5BD	Panel van MWB	£430.00	£516.00	●	●
		Panel van LWB	£505.00	£606.00	●	●
		Panel van LWB Maxi	£580.00	£696.00	●	●
LED lights in load compartment. Includes four lights.	9CW	Panel van	£220.00	£264.00	£220.00	£264.00

● Standard – Not available ○ At no extra cost

Where additional equipment is required by chosen options, this will be at additional cost. See the relevant option for recommended pricing or consult your local authorised Van Centre.

Volkswagen Commercial Vehicles may change RRP's at any time (this includes where there are government changes in regulation and/or legislation). There may be a delay to any RRP displaying correctly on our materials. Always obtain prices from your chosen authorised Van Centre.

Panel van options (continued)

Cargo area (continued)	PR Code	Van	Startline		Trendline			
			Basic exc. VAT	Total RRP inc. VAT	Basic exc. VAT	Total RRP inc. VAT		
Load lashing rings.	6B1	Panel van	●	●	●	●		
Load lashing rings – deleted.	6B0	Panel van	○	○	○	○		
Load side lining, plywood full height. The load/passenger compartment is fitted with plywood trim up to the roof on the side panels, the rear-wing doors and the load compartment sliding doors.	5DU	Panel van MWB	£540.00	£648.00	£540.00	£648.00		
		Panel van LWB	£605.00	£726.00	£605.00	£726.00		
		Panel van LWB Maxi	£670.00	£804.00	£670.00	£804.00		
Electrical								
Smart tachograph – digital. Standard on CR50 models.	9NI/4N7	Panel van	£635.00	£762.00	£635.00	£762.00		
Two 12V sockets in cab (in the dashboard).	EU1	Panel van	●	●	●	●		
Two 12V sockets in load/passenger compartment.	7B3	Panel van	£60.00	£72.00	£60.00	£72.00		
Heating and ventilation								
Climatic air conditioning in cab.	See Business Pack offer.		ZK1	Panel van	£1,495.00	£1,794.00	£1,495.00	£1,794.00
Windows								
Heated windscreen.	4GX	Panel van	-	-	£235.00	£282.00		

● Standard – Not available ○ At no extra cost

Where additional equipment is required by chosen options, this will be at additional cost. See the relevant option for recommended pricing or consult your local authorised Van Centre.

Volkswagen Commercial Vehicles may change RRP's at any time (this includes where there are government changes in regulation and/or legislation). There may be a delay to any RRP displaying correctly on our materials. Always obtain prices from your chosen authorised Van Centre.

Panel van options (continued)

	PR Code	Van	Startline		Trendline	
			Basic exc. VAT	Total RRP inc. VAT	Basic exc. VAT	Total RRP inc. VAT
Safety and security						
Airbag – driver’s.	4UC	Panel van	●	●	●	●
Airbags – driver’s and front passenger’s airbag with front passenger’s airbag deactivation.	4UF	Panel van	£200.00	£240.00	£200.00	£240.00
Airbags – driver’s side and curtain.	4X6	Panel van	£770.00	£924.00	£770.00	£924.00
Airbags – driver’s and front passenger’s side and curtain.	4X3	Panel van	£900.00	£1,080.00	£900.00	£1,080.00
Anti-theft alarm system – with interior monitoring, back-up horn and tow-away protection. Overhead storage compartment with two 1-DIN slots and reading light. See Business Pack offer.	7AQ/QE4	Panel van	£670.00	£804.00	£670.00	£804.00
Anti-theft alarm system – with interior monitoring, back-up horn and tow-away protection. Overhead storage compartment with two 1-DIN slots and reading light. Also including SAFELOCK.	4K3/7AQ/QE4	Panel van	£670.00	£804.00	£670.00	£804.00
Automatic Post-Collision Braking. Triggers braking after a collision, with the aim of preventing secondary collisions.	1AS	Panel van	●	●	●	●
Two remote control folding keys.	8QJ	Panel van	●	●	●	●
Four remote control folding keys.	8QL	Panel van	£75.00	£90.00	£75.00	£90.00
Tyre pressure warning light.	7K3	Panel van	£330.00	£396.00	£330.00	£396.00
Business Pack						
Anti-theft alarm system – with interior monitoring, back-up horn and tow-away protection. Overhead storage compartment with two 1-DIN slots and reading light. Climatic air conditioning in cab. Front and rear parking sensors. (Only compatible with a bulkhead).	W56	Panel van	£1,320.00	£1,584.00	£1,320.00	£1,584.00

● Standard – Not available ○ At no extra cost

Where additional equipment is required by chosen options, this will be at additional cost. See the relevant option for recommended pricing or consult your local authorised Van Centre.

Volkswagen Commercial Vehicles may change RRP's at any time (this includes where there are government changes in regulation and/or legislation). There may be a delay to any RRP displaying correctly on our materials. Always obtain prices from your chosen authorised Van Centre.

Upgrade with the Business Pack.

You can drive away in an upgraded Volkswagen Crafter for less thanks to the Business Pack. Available on the Crafter Startline and Trendline panel van models, the discounted pack features front and rear parking sensors, air-conditioning, an alarm and an overhead storage compartment in the cab for as little as £1,320 +VAT. That's a saving for you and your business.



Panel van converter options

			Startline		Trendline	
	PR Code	Van	Basic exc. VAT	Total RRP inc. VAT	Basic exc. VAT	Total RRP inc. VAT
Seating						
Without passenger's seat.	3TA	Panel van	-£205.00	-£246.00	-	-
Without passenger's seat but with low seat substructure.	3TI	Panel van	-£155.00	-£186.00	-	-
Wheel and tyre accessories						
16" steel wheels. 6.5J x 16 with 1,050kg load in Black.	C1G	Panel van	○	○	○	○
Low rolling resistance tyres 235/65 R16 C115/113 R.	Q70	Panel van	○	○	○	○
Comfort and convenience						
Step illumination. Includes on/off control.	9N2	Panel van	£55.00	£66.00	£55.00	£66.00
Body and chassis						
Driver door, reinforced (hinge).	OD3	Panel van	£60.00	£72.00	£60.00	£72.00
Fuel tank – 63 litre volume.	OM3	Panel van	○	○	○	○
Fuel tank – 75 litre volume.	ON0	Panel van	●	●	●	●
Front axle – heavy duty (2,200kg load).	VV8	Panel van	£265.00	£318.00	£265.00	£318.00
Indicators – high level, rear only.	9H1	Panel van	£135.00	£162.00	£135.00	£162.00
Rotating emergency light preparation.	9LX	Panel van	£40.00	£48.00	£40.00	£48.00
Run lock. The run lock system allows the engine to keep running even though the key has been taken out of the ignition.	7U4	Panel van	£540.00	£648.00	£540.00	£648.00
Suspension and shock absorbers, uprated heavy-duty stabilisers.	2MG	Panel van	£280.00	£336.00	£280.00	£336.00
Cargo area						
Roof lining – in cab and load/passenger compartment, a moulded fibrous fleece interior roof lining. Only in combination with certain rear window configurations.	5CE	Panel van	£600.00	£720.00	£600.00	£720.00
Without floor covering in load/passenger compartment.	5BA	Panel van	●	●	-£200.00	-£240.00

● Standard – Not available ○ At no extra cost

Where additional equipment is required by chosen options, this will be at additional cost. See the relevant option for recommended pricing or consult your local authorised Van Centre.

Detailed information regarding tyre efficiency labelling and technical specifications on all potential tyre fitments can be found by visiting the Volkswagen Commercial Vehicles online car configurator at www.volkswagen-vans.co.uk/en/configurator.html

Volkswagen Commercial Vehicles may change RRP's at any time (this includes where there are government changes in regulation and/or legislation). There may be a delay to any RRP displaying correctly on our materials. Always obtain prices from your chosen authorised Van Centre.

Panel van converter options (continued)

	PR Code	Van	Startline		Trendline	
			Basic exc. VAT	Total RRP inc. VAT	Basic exc. VAT	Total RRP inc. VAT
Electrical						
AGM battery (95Ah, 520A) and stronger generator 180A.	NY4	Panel van	£295.00	£354.00	£295.00	£354.00
Acoustic warning signal when reverse gear is engaged, can be deactivated.	IL2	Panel van	£260.00	£312.00	£260.00	£312.00
Battery – uprated 110Ah.	NY2	Panel van	£45.00	£54.00	£45.00	£54.00
Deep-cycle AGM starter battery (92Ah, 520A). This option removes KFG preparation from the vehicle.	NY5	Panel van	£100.00	£120.00	£100.00	£120.00
DPF regeneration switch. Only in combination with Terminal block CFCU IS2, IS3, IS4, IS6, IS7 or IS8.	9HC	Panel van	£205.00	£246.00	£205.00	£246.00
Second battery with cut-off relay 92Ah 520A.	8FB	Panel van	£325.00	£390.00	£325.00	£390.00
Second AGM battery with cut-off relay 95Ah 450A.	8FD	Panel van	£325.00	£390.00	£325.00	£390.00
Second AGM battery with cut-off relay 92Ah 520A.	8FE	Panel van	£370.00	£444.00	£370.00	£444.00
Second AGM battery with cut-off relay and battery monitoring 92Ah 520A.	8FK	Panel van	£370.00	£444.00	£370.00	£444.00
Terminal block.	IS1	Panel van	£80.00	£96.00	£80.00	£96.00
Terminal block and preparation for function control module 1 with body builder ABH programming.	IS2	Panel van	£370.00	£444.00	£370.00	£444.00
Terminal block and preparation for function control module 1 with telematics preparation and body builder ABH programming.	IS3	Panel van	£600.00	£720.00	£600.00	£720.00
Terminal block and preparation for function control module 2 with body builder ABH programming.	IS7	Panel van	£395.00	£474.00	£395.00	£474.00
Terminal block and preparation for function control module 2 with telematics preparation and body builder ABH programming. Customer specific function control module (KFG Mid) WLAN, USB and Bluetooth®.	IS8	Panel van	£640.00	£768.00	£640.00	£768.00
12V sockets – two in front.	EU1	Panel van	●	●	●	●
Heating and ventilation						
Water auxiliary heater. With programmable parking heater and remote control.	7VL	Panel van	£960.00	£1,152.00	£960.00	£1,152.00

● Standard – Not available ○ At no extra cost

Where additional equipment is required by chosen options, this will be at additional cost. See the relevant option for recommended pricing or consult your local authorised Van Centre.

Volkswagen Commercial Vehicles may change RRP's at any time (this includes where there are government changes in regulation and/or legislation). There may be a delay to any RRP displaying correctly on our materials. Always obtain prices from your chosen authorised Van Centre.

Panel van converter options (continued)

	PR Code	Van	Startline		Trendline	
			Basic exc. VAT	Total RRP inc. VAT	Basic exc. VAT	Total RRP inc. VAT
Safety and security						
Speed limiter – 62mph.	7H2	Panel van	£105.00	£126.00	£105.00	£126.00
Speed limiter – 74mph.	7H3	Panel van	£105.00	£126.00	£105.00	£126.00
Heating and ventilation						
Side window – fixed in passenger compartment centre passenger side.	6VH	Panel van	£145.00	£174.00	£145.00	£174.00
Side window – fixed in passenger compartment centre driver side.	6WH	Panel van	£145.00	£174.00	£145.00	£174.00
Side window – fixed in passenger compartment front passenger side.	4DE	Panel van	£145.00	£174.00	£145.00	£174.00
Side window – fixed in passenger compartment front driver side.	4EE	Panel van	£145.00	£174.00	£145.00	£174.00
Side window – fixed in passenger compartment rear passenger side.	4FH	Panel van	£145.00	£174.00	£145.00	£174.00
Side window – fixed in passenger compartment rear driver side.	4JH	Panel van	£145.00	£174.00	£145.00	£174.00
Side window – sliding in passenger compartment front passenger side.	4DM	Panel van	£330.00	£396.00	£330.00	£396.00
Side window – sliding in passenger compartment front driver side.	4EM	Panel van	£330.00	£396.00	£325.00	£390.00

● Standard – Not available ○ At no extra cost

Where additional equipment is required by chosen options, this will be at additional cost. See the relevant option for recommended pricing or consult your local authorised Van Centre.

Volkswagen Commercial Vehicles may change RRP's at any time (this includes where there are government changes in regulation and/or legislation). There may be a delay to any RRP displaying correctly on our materials. Always obtain prices from your chosen authorised Van Centre.

Accessories

100% safety and security. 100% Volkswagen.

Add extra security, protection and practicality to your new Crafter, while still keeping it 100% Volkswagen. Our range of rugged and long-lasting Accessories are a perfect match for fit and allow you to truly customise your vehicle. Whether you want added technology or need extra flexibility with a sturdy towbar, there's something in our Accessories range for you. And remember, most Accessories include a two-year warranty for added peace-of-mind.



Illustrations may include options at extra charge. Please contact your local Volkswagen Commercial Vehicles Van Centre for details of the standard equipment and optional extras available.

Want to discover more?
Pop into your nearest Van Centre
or call **0800 717 131.**

Finance made simple

As dedicated to finance as we are to your new Crafter panel van

Learn more about our range of finance products to find a finance package that suits your budget. Alternatively, 'Click on' the Offers & Finance button above to find out more about our latest offers to help your business thrive.

Cost of your vehicle

Deposit
As little as one monthly repayment

Repayments
Spread across 12 to 60 months



Own

Hire Purchase

Make all the regular monthly payments. At the end the vehicles is yours.

Cost of your vehicle

Deposit
As little as one monthly repayment

Rental repayments
Spread across 12 to 48 months

Final 'balloon' repayment



Own

Lease Purchase

Make lower monthly payments by deferring an amount until the end. Once paid the vehicle is yours.

Cost of your vehicle

Initial rental
As little as one rental repayment

Rental repayments
Spread across 12 to 60 months



Hire

Contract Hire

Pay fixed monthly rentals to hire the vehicle. Look after it so at the end you can return it hassle free.

Cost of your vehicle

Initial rental
As little as one rental repayment in advance

Rental repayments
Spread across 12 to 60 months



Hire

Finance Lease (full pay out)

Pay monthly rentals to hire the vehicle. At the end you have two options. Sell the vehicle and receive a percentage of the sale proceeds. Or retain the use of your vehicle by paying a reduced annual rental.

Cost of your vehicle

Initial rental
As little as one rental repayment in advance

Rental repayments
Spread across 12 to 48 months

Final 'balloon' repayment
You have two options at the end of your agreement



Hire

Finance Lease (balloon repayment)

Pay monthly rentals to hire the vehicle. At the end you have two options. Sell the vehicle to settle the outstanding amount and receive any excess sale proceeds. Or pay the 'balloon' payment and retain the use of your vehicle by paying a reduced annual rental.

Illustrations include options at extra charge. Please contact your local Volkswagen Commercial Vehicles Van Centre for details of the standard equipment and optional extras applicable in your country.

Finance subject to status. Available to 18s and over in the UK only. Terms and Conditions apply. Volkswagen Commercial Vehicle Financial Services.

Finance, insurance, servicing and warranties

Finance and insurance.¹

When it comes to paying for your van, we've got options including Contract Hire and Finance Lease, or Hire Purchase. We can also offer you competitive insurance with lots of features and benefits as standard.

A choice of packages.²

Whether you prefer to lease your vehicles, with none of the concerns of ownership and the freedom to change models easily, or purchase outright to own the vehicle that's perfect for your business, we're here to help you consider your options.

You can go flexible, by choosing a payment plan that suits your finances, with options to reduce your monthly costs and your repayment period. Or choose a fixed monthly price that allows you to budget confidently for the longer term.

You can even include your road tax and servicing costs to arrive at one simple, all-inclusive payment. For more information, pick up a finance brochure, or ask at your Van Centre.

Volkswagen Commercial Vehicle Van Insurance.³

Complimentary Drive Away Insurance

Every new and used Volkswagen Commercial Vehicle comes with five days' complimentary Drive Away Insurance, so you can enjoy your new vehicle from day one. We will also provide you with a quote, giving you the option to purchase annual cover, so you can enjoy the same peace-of-mind for a further twelve months. Please speak to your local Volkswagen Van Centre for further details.

Subject to eligibility. Five days' Drive Away Insurance cannot be used in conjunction with any other insurance offer.

Annual Insurance

Comprehensive van insurance, designed specifically for Volkswagen Commercial Vehicles, to offer you maximum convenience with minimum hassle – just as you'd expect.

If you take out a new Volkswagen Commercial Vehicle Van Insurance policy you will receive the following benefits at no additional cost:

- All repairs are carried out by Volkswagen Commercial Vehicles' Trained Technicians in Volkswagen Commercial Vehicles' Authorised Repairers
- Genuine parts and accessories (excludes windscreen claims)
- Courtesy van while yours is being repaired
- Cover for the full cost of repairs to chips or other small damage to your windscreen
- Up to 90 days' foreign travel cover, when using your van abroad
- Up to £250 cover for personal belongings that are lost or damaged following an accident, fire or theft

For more information or to get a quote, call us on: **0345 877 6355**

We're available Monday to Friday 9am-6pm.

Alternatively, visit: www.insurewithwvcv.co.uk

Volkswagen Commercial Vehicle GAP Insurance.⁴

If your Volkswagen Commercial Vehicle is written off, your motor insurer will usually settle your claim based on the current market value of your vehicle. This could be substantially less than the original value of your vehicle.

Volkswagen Commercial Vehicle GAP (also known as 'Guaranteed Asset Protection') Insurance helps to bridge the payment gap to get you back in a new Volkswagen Commercial Vehicle. Whether you purchase, finance, lease or hire your vehicle, Volkswagen Commercial Vehicle GAP Insurance is available and can be arranged up to 60 days after you have collected your new or used vehicle.

For more information about Volkswagen Commercial Vehicle GAP Insurance, visit: www.insurewithwvcv.co.uk/gap-insurance

Servicing and support.

We're here to keep your business moving, with our range of three award-winning⁵ servicing and maintenance options, as well as free Roadside Assistance. Some exclusions apply. For more detail, please visit: www.volkswagen-vans.co.uk/aftersales

Fixed cost maintenance.

This option is available for vehicles that are less than twelve months old and have covered less than 10,000 miles. It makes budgeting easier by splitting the cost of servicing into fixed monthly payments – whether you want Service only; Service and Maintenance; or Service, Maintenance and Tyres.

Fixed price servicing.⁶

If you can pay for more than one service upfront, we'll help by reducing your costs. Buy two upfront and you'll receive one interim and one full service at a discounted rate. Buy four and you'll receive two interim and two full services, with your next MOT also included. You can also spread the cost with monthly payments, helping you budget⁷.

Pay on demand.

If you're looking for freedom and flexibility with your servicing, it's good to know we're ready when you are. So with our third option, you can choose to pay for your services as and when you need them, with our National Service Pricing. Ask your Van Centre for an up-to-date pricing guide.

Roadside Assistance.

We understand the need to keep you mobile. That's why all new vans come with three-year, unlimited mileage roadside cover. Should the unexpected happen, one call gets you straight through to a team trained to help you through any breakdown or accident. Supporting you every day will be a team of vehicle technicians, fully-trained by Volkswagen and carrying the latest diagnostic equipment, specialist tools and parts.

Assistance benefits include:

- Assistance at home, by the roadside or place of work.
- Recovery to your preferred location.
- Onward travel, for you and your cargo.
- Cover 24 hours a day, 365 days a year.
- Free cover for three years (on new vehicles).
- Unlimited mileage.
- European cover.
- Option to extend cover beyond three years.

Warranties.

You can count on us long after you purchase your new Crafter panel van, thanks to its comprehensive three-year unlimited mileage warranty. You choose Volkswagen because your business depends on it, year in, year out. While your new Crafter panel van is under warranty, we'll fix any defect in manufacture or workmanship free of charge, even if you purchase and service the vehicle at different Van Centres. Some exclusions apply and the vehicle must be cared for using the guidance in your owner's manual.

For more detail, please visit www.volkswagen-vans.co.uk/aftersales.

Extended warranty.

You can also extend your warranty beyond the standard warranty period, choosing either Comprehensive or Major Component cover, as a one-off or monthly payment.

For more detail of cover levels, along with terms and conditions, please visit www.volkswagencvwarranty.co.uk where you'll also be able to obtain a quote and purchase an extended warranty.

Paint and body warranty.

Your new Crafter panel van's exterior paintwork is covered against manufacturing defects for a period of three years, while its body sections and panels are covered against rusting through from the inside for twelve years. Some exclusions apply and the vehicle must be cared for using the guidance in your owner's manual.

1 Volkswagen Commercial Vehicles Insurance and Volkswagen Commercial Vehicle Financial Services are trading names of Volkswagen Financial Services (UK) Limited, Brunswick Court, Yeomans Drive, Blakelands, Milton Keynes MK14 5LR, which is authorised and regulated by the Financial Conduct Authority (FCA). Registered in England and Wales number: 2835230. Volkswagen Financial Services (UK) Limited financial services register number is 311988.

2 An offer of finance depends on certain conditions. Finance subject to status. Available to 18s and over. Terms and conditions apply. Volkswagen Commercial Vehicle Financial Services.

3 Volkswagen Commercial Vehicle Insurance is arranged by U K Insurance Business Solutions Limited and is underwritten by U K Insurance Limited. Calls may be recorded. Volkswagen Commercial Vehicle Financial Services is a trading name of Volkswagen Financial Services (UK) Limited ('VWFS UK'). Registered office: Brunswick Court, Yeomans Drive, Blakelands, Milton Keynes MK14 5LR. Volkswagen Insurance Service (Great Britain) Limited is an appointed representative of VWFS UK. VWFS UK is authorised and regulated by the Financial Conduct Authority. VWFS UK and U K Insurance Limited are not part of the same corporate group.

4 Volkswagen Commercial Vehicle GAP Insurance is administered by Abraxas Insurance Administration Services and underwritten by MAPFRE Asistencia Compañía Internacional de Seguros y Reaseguros, S.A. ('MAPFRE'). VWFS UK is not part of the same corporate group as MAPFRE and Abraxas Insurance Administration Services Limited.

5 Business Vans Awards 2014 and 2015: Best Service Package for Van Owners.

6 Class 4 MOT only. This option is available to all new and used vehicles up to seven years old with no mileage restrictions.

7 Pay monthly option eligible on vehicles with under 200,000 miles at point of activation.

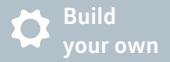

Build
your own



Find a
Tour Centre



Test drive



Offers &
Finance



Conversions



The Crafter panel van

This brochure supersedes all previous publications.
Issue: 1 May 2021
www.volkswagen-vans.co.uk

Please note: Screen technology does not allow exact reproduction of the paint and upholstery colours. Some of the vehicles shown are European specification and may be fitted with optional equipment or accessories that are available at extra cost, or do not reflect current specification. All data and specifications are in accordance with information available at the time of publication and are subject to change without notice. Vehicles not currently in UK stock and customer order vehicles may take a number of weeks for delivery. Certain combinations of vehicle specifications and factory-fitted options are not compatible and therefore all orders received are subject to confirmation. Models, factory fitted-options and paint and upholstery options are subject to availability. Please check details and availability with an authorised Volkswagen Van Centre at the time of ordering.