

Best viewed in landscape mode



# 4



T H E

# THE BMW Z4.

RETURN BY CLICKING [🏠](#)  
SELECT A TOPIC BELOW TO EXPLORE:



## FEATURED MODEL.

### BMW Z4 M40i:

M TwinPower Turbo six-cylinder in-line petrol engine, 340hp (250kW), 19" M light alloy Double-spoke style 799 M wheels, Jet Black, San Francisco Red metallic paint, M Sport seats upholstered in Ivory White Vernasca leather with decorative stitching, Aluminium Mesh effect interior trim, instrument panel in Sensatec, High-gloss Shadowline exterior trim with extended contents.

Content correct at time of publishing (as of January 2021). Prices and technical data subject to change. The models shown on these pages may feature optional equipment. Standard equipment may also vary depending on engine variant. For further details, please contact your local BMW Centre.



"IT'S NOW A CAR WITH FINE BODY CONTROL AND A CHASSIS THAT COMBINES TRADEMARK BMW REAR-DRIVE HANDLING POISE WITH LOTS OF LATERAL GRIP AND TRACTION. THE CAR'S HANDLING IS ACCURATE AND COMPOSED, IT HAS USEFULLY GOOD HIGH-SPEED STABILITY AND IT'S PLENTY OF FUN TO DRIVE."

Autocar

[Read the full review](#)



"THE Z4'S CHASSIS RELAXES NICELY INTO COMMUTING OR LONG-HAUL WORK. AND WHILE YOU'RE AT IT, THE DRIVER AIDS AND HEADLAMPS ARE ALL YOU'D EXPECT FROM MODERN GERMAN PREMIUM."

Top Gear

[Read the full review](#)

M40i.



The BMW Z4 M40i model is shown above in San Francisco Red metallic paint.

■ Standard equipment □ Optional equipment

M40i.



In addition / replacement to Sport models

EXTERIOR

- 19" M light alloy Double-spoke style 800 M wheels, Bicolour Cerium Grey
- Exterior trim, High-gloss Shadowline
- M aerodynamics bodystyling

INTERIOR

- M Leather steering wheel
- Seat adjustment – front, electric with driver memory
- Lumbar support, driver and front passenger
- Instrument panel in Sensatec
- Interior trim, Aluminium Tetragon

SAFETY & TECHNOLOGY

- Adaptive M suspension
- M Sport braking system
- M Sport differential
- BMW TwinPower Turbo six-cylinder petrol engine



The BMW Z4 M40i model is shown above in San Francisco Red metallic paint.

■ Standard equipment □ Optional equipment

M SPORT.



The BMW Z4 M Sport model is shown above in Misano Blue metallic paint with optional 19" M Double-spoke style 799 M wheels, Bicolour Jet Black.

■ Standard equipment □ Optional equipment

# M SPORT.

In addition / replacement to Sport models

## EXTERIOR

- 18" M light alloy Double-spoke style 798 M wheels, Bicolour Ferric Grey
- Exterior trim, High-gloss Shadowline
- M aerodynamics bodystyling

## INTERIOR

- M Leather steering wheel
- Interior trim, Aluminium Tetragon

## SAFETY & TECHNOLOGY

- M Sport suspension
- M Sport braking system (sDrive30i only)



The BMW Z4 M Sport model is shown above in Misano Blue metallic paint with optional 19" M Double-spoke style 799 M wheels, Bicolour Jet Black.

■ Standard equipment □ Optional equipment



SPORT.



The BMW Z4 Sport model is shown above in Mineral White metallic paint.

■ Standard equipment □ Optional equipment

# SPORT.

## EXTERIOR

- 18" light alloy V-spoke style 770 wheels, Bicolour Orbit Grey

## INTERIOR

- M Sport seats, front
- Seat heating, front
- Sport multi-function leather steering wheel, three-spoke
- Air conditioning, automatic with two-zone control
- Interior rear-view mirror with automatic anti-dazzle function
- Instrument panel in Sensatec
- Interior trim, High-gloss Black
- Vernasca leather upholstery
- Ambient lighting
- Extended storage
- Floor mats, velour

## SAFETY & TECHNOLOGY

- Active Guard
- Connected Package Professional
- LED headlights
- Brake lights with LED technology, Dynamic
- Cruise control with brake function
- Park Distance Control (PDC), front and rear
- Eight-speed sport automatic transmission with gearshift paddles
- Tyre pressure monitoring

## AUDIO & COMMUNICATION

- BMW Live Cockpit Professional, comprising:
  - 10.25" Control Display with Touch Functionality
  - 10.25" Digital Instrument Display
  - BMW Operating System 7.0
  - iDrive Controller with Touch Function
  - Remote Software Upgrade
- Connected Package Professional
- Bluetooth hands-free facility with USB audio interface
- Loudspeaker system – BMW Advanced



# EXTERIOR COLOURS.

ALL MODELS.



Non-metallic Alpine White



Metallic Black Sapphire

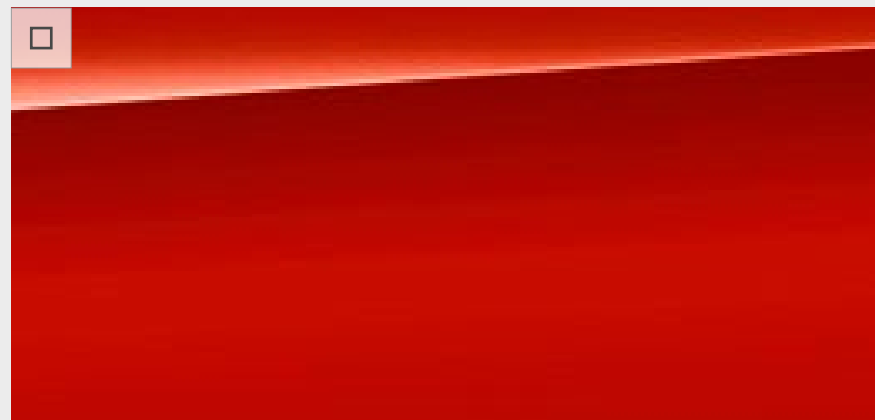

Metallic San Francisco Red

EXCLUSIVELY FOR SPORT MODELS.



Metallic Mineral White



Metallic Glacier Silver



Metallic Mediterranean Blue

EXCLUSIVELY FOR sDRIVE30i M SPORT & M40i MODELS.

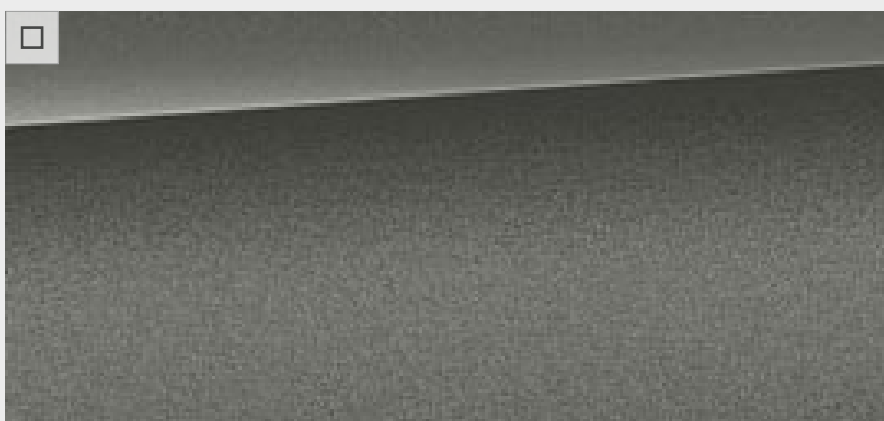

Frozen Grey II

EXCLUSIVELY FOR M SPORT & M40i MODELS.



Metallic Misano Blue

**Colour samples** These colour samples are intended as an initial guide to the colours and materials available for your BMW. Please discuss your preferred colour choices with your BMW Centre. There you can also see original samples and be assisted with any requests.

■ Standard equipment   □ Optional equipment

# UPHOLSTERY & INTERIOR TRIMS.

## LEATHER.

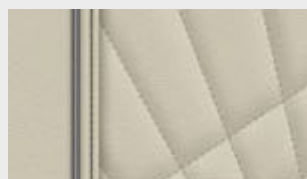

Vernasca leather in Ivory White with decorative stitching

Available with  
 Sport  
 M Sport  
 M40i

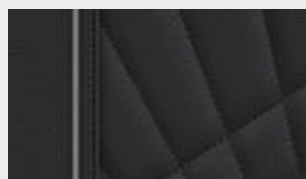

Vernasca leather in Black with decorative stitching

Available with  
 Sport  
 M Sport  
 M40i

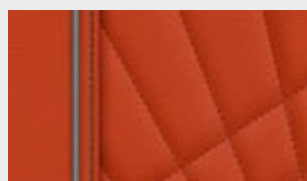

Vernasca leather in Magma Red with decorative stitching

Available with  
 Sport  
 M Sport  
 M40i

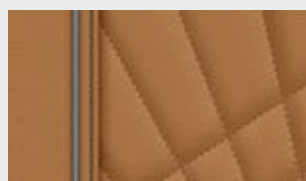

Vernasca leather in Cognac with decorative stitching

Available with  
 Sport  
 M Sport  
 M40i

## INTERIOR TRIMS.

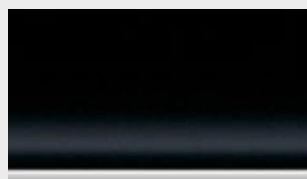

High-gloss, Black

Available with  
 Sport  
 M Sport  
 M40i



Aluminium Mesh effect

Available with  
 Sport  
 M Sport  
 M40i



Aluminium Tetrakon

Available with  
 M Sport  
 M40i



Please note that even normal long- or short-term use can lead to unrecoverable upholstery damage. This can be caused in particular by non-colourfast clothing.

■ Standard equipment   □ Optional equipment

# PACKAGES.

Optional packages offer an attractive combination of the most popular options at a reduced (combined) cost and will enhance any journey in the BMW Z4.

## M SPORT PRO PACKAGE.

- 19" M light alloy Double-spoke style 799 M wheels, Bicolour Jet Black
- Adaptive M suspension
- Exterior trim, Extended High-gloss Shadowline
- M seat belts
- M Sport braking system (sDrive20i only)
- M Sport differential (sDrive30i only)

Exclusively available for M Sport models.

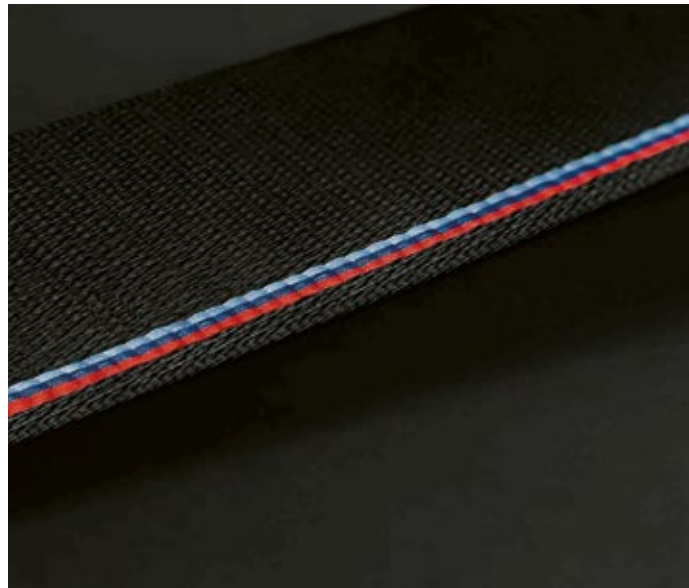

## COMFORT PACKAGE.

- Comfort Access with smart-opener
- Steering wheel heating
- Through-loading system
- Wind deflector



## COMFORT PLUS PACKAGE.

- Comfort Package
- Lumbar support for driver and front passenger
- Seat adjustment – front, electric with driver memory

Exclusively available for Sport and M Sport models.



## TECHNOLOGY PACKAGE.

- Enhanced Bluetooth with wireless charging
- Head-up Display
- Loudspeaker system – harman/kardon
- Parking Assistant
- WiFi hotspot preparation



## SHADOWLINE PLUS.

- 19" M light alloy Double-spoke style 799 M wheels, Jet Black
- Exterior trim, Extended High-gloss Shadowline
- Mirror caps, Black



## VISIBILITY PACKAGE.

- Adaptive LED headlights
- High-beam Assistant



## DRIVING ASSISTANCE PACKAGE.

- Active Cruise Control with Stop&Go function
- Driving Assistant, including:
  - Approach Control Warning
  - Crossing-traffic Warning
  - Lane Change Warning
  - Lane Departure Warning
  - Preventive of rear collision
  - Speed-limit information and no-overtaking indicator



# OPTIONAL EQUIPMENT HIGHLIGHTS.

## M SPORT BRAKING SYSTEM.

The M Sport braking system has a four-piston fixed brake design with calipers in Blue with the M designation.

Exclusively available as part of the M Sport Pro Package for sDrive20i M Sport models. Standard on the sDrive30i M Sport and M40i models.



## LOUDSPEAKER SYSTEM – HARMAN/KARDON.

As part of Technology Package, the harman/kardon loudspeaker system with 365W digital amplifier, seven channels, vehicle-specific equalizing and twelve loudspeakers.



## WIND DEFLECTOR.

The Wind deflector provides the driver and front passenger with effective protection from draughts at neck and shoulder-height even when travelling at high speeds. The deflector is collapsible. The interior mirror can be used when the wind deflector is mounted.



## HEAD-UP DISPLAY.

The full-colour Head-up Display projects all information relevant to the journey directly into the driver's field of vision. Display of full content is dependent on optional equipment ordered.

Exclusively available as part of the Technology Package.



## ADAPTIVE LED HEADLIGHTS.

The Adaptive LED headlights include integrated LED front indicators, low and high beam headlights as well as daytime driving lights. BMW Selective Beam and Adaptive Headlights significantly improve visibility in the dark for more relaxed driving.

Exclusively available as part of the Visibility Package.



## STEERING WHEEL HEATING.

At the touch of a button, the steering wheel heating quickly warms up the steering wheel rim to a pleasant temperature allowing the driver to comfortably and safely steer the vehicle without the use of gloves.

Included in the Comfort and Comfort Plus Packages.



## DRIVING ASSISTANT.

Driving Assistant supports you in various driving situations and brakes automatically in an emergency. Features include Lane Departure and Lane Change Warnings, Approach control warning, Crossing traffic warning, Rear collision prevention and Speed Limit Info.

Exclusively available as part of the Driving Assistance Package.

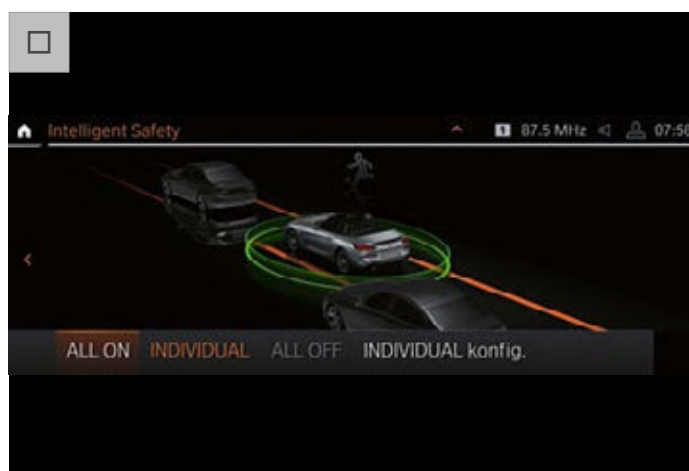

## ADAPTIVE M SUSPENSION.

The Adaptive M suspension offers the choice of a comfortable yet sporty suspension design. It is controlled via Drive Performance Control. It consists of adaptive damper control with lowering of 10mm and automatic ride height adjustment depending on vehicle load.

Standard on the M40i model. Exclusively available as part of the M Sport Pro Package.



# BMW CONNECTED DRIVE.

BMW ConnectedDrive enables you to remain connected to the outside world from the comfort of your BMW.

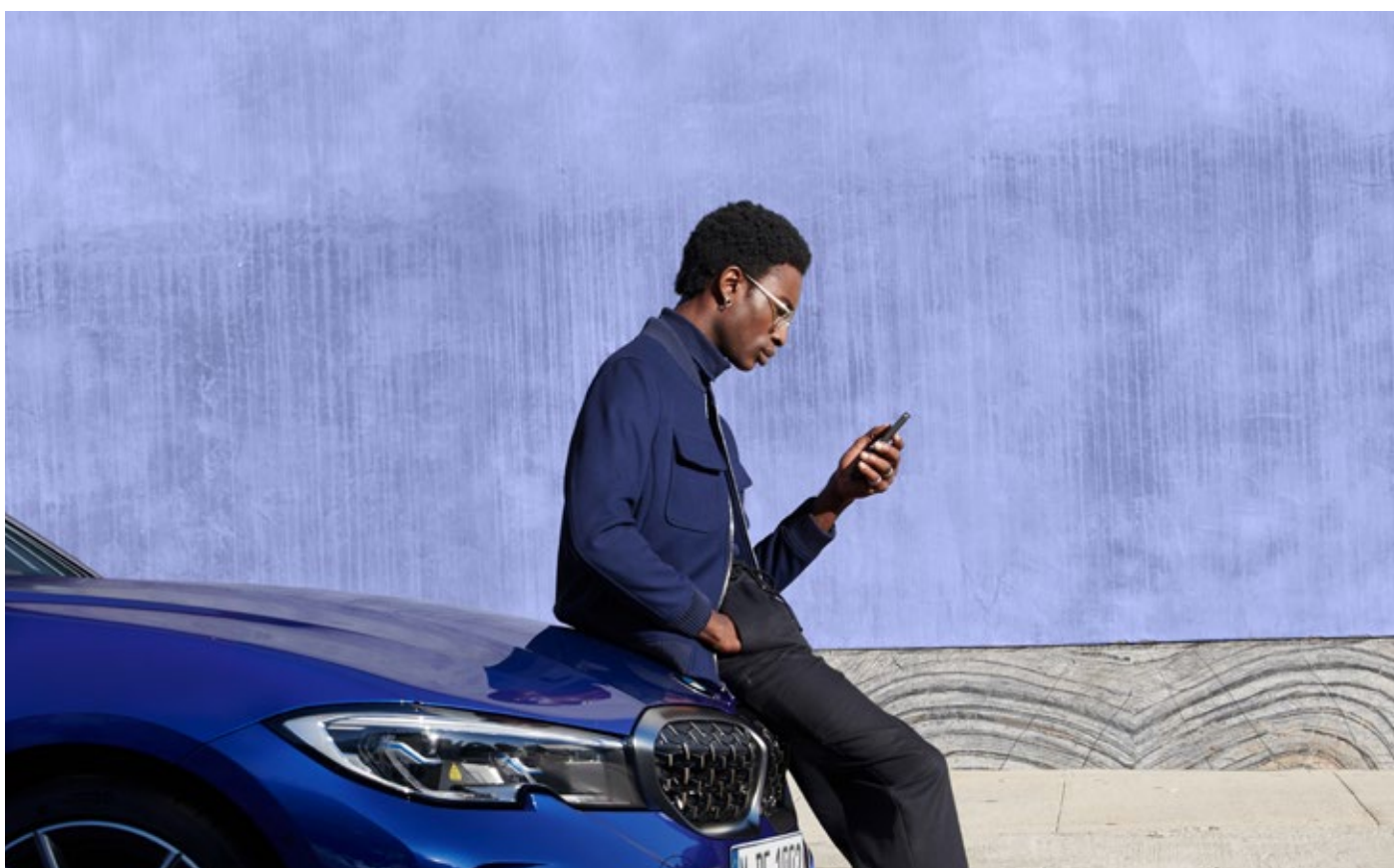

## ■ BMW LIVE COCKPIT PROFESSIONAL

- **BMW Apps** makes it possible to operate apps such as BMW Connected.
- **BMW Emergency Call** automatically creates a direct link to the local emergency services.
- **BMW Intelligent Personal Assistant** understands natural speech. It interacts with your BMW and has the ability to learn driver preferences.
- **BMW Online Services** provides a seamless integration of personalised BMW Connected mobility-related services.
- **BMW Teleservices** supports the processing of servicing appointments and sends vehicle-specific service data to BMW.
- **Intelligent Functionalities** creates customised rules and learns the driver's habits to enable greater comfort on every journey.
- **Last State Call** transfers vehicle-based data to the BMW Connected App, allowing you to view current mileage, fuel status and other features from your phone.
- **Map updates** automatically updates the maps in your BMW by downloading them over the air.



## ■ CONNECTED PACKAGE PROFESSIONAL.

- **BMW Maps** makes route planning easier, anticipates road conditions and provides an estimated time of arrival.
- **Concierge Services** connects the driver to a BMW Call Centre agent around-the-clock.
- **Connected Music** offers unlimited streaming of millions of songs in the vehicle from Spotify.
- **Connected Parking** offers multi-story and on-street parking information in selected cities in the UK and Europe.
- **In-Car Experiences** takes care of you and adapts the interior ambience to suit your mood.
- **Real Time Traffic Information** supplies details about the location and duration of traffic delays.
- **Remote Services** allows you to remain connected to your vehicle from your phone.
- With **Smartphone Integration**, your vehicle supports Apple CarPlay® and Android Auto®. This way, you can access your usual apps in the vehicle.

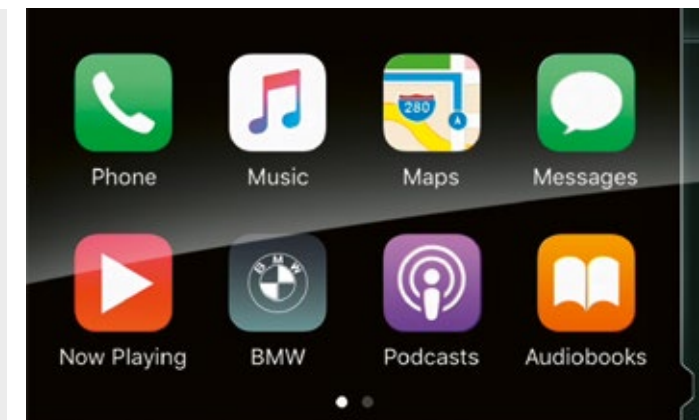

## ■ CONNECTED TEASER.

Three month trial of the following service:

- **BMW Music** brings your favourite soundtracks to your BMW.

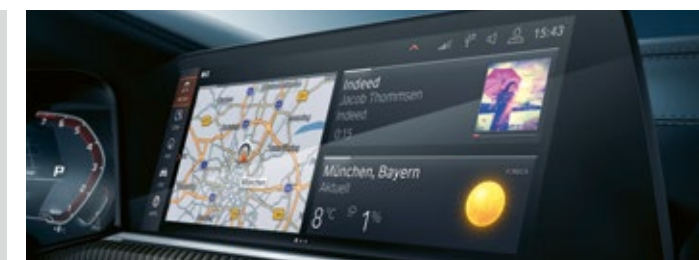

## MY BMW APP.

The My BMW App is the direct connection inside and outside your BMW. Plan your next trip, check the status of your vehicle or use one of the remote service functions – all conveniently from your smartphone.

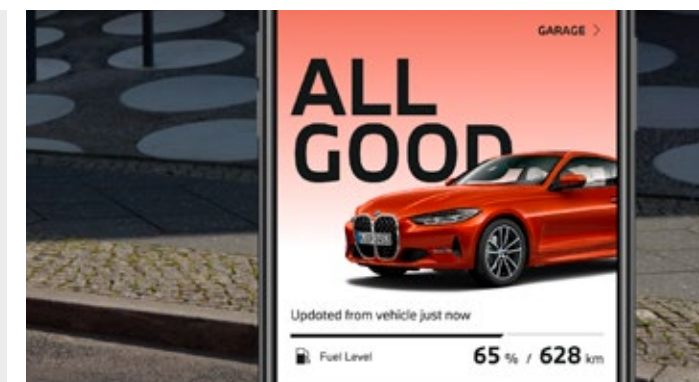

## WHEELS & TYRES.

19" M LIGHT ALLOY DOUBLE-SPOKE STYLE 800 M WHEELS, BICOLOUR CERIUM GREY.

19" M light alloy Double-spoke style 800 M wheels, Bicolour Cerium Grey, front 9 J x 19 with 255/35 ZR19, rear 10 J x 19, 275/35 ZR19 tyres.

Standard on M40i models.



19" M LIGHT ALLOY DOUBLE-SPOKE STYLE 799 M WHEELS, BICOLOUR JET BLACK.

19" M light alloy Double-spoke style 799 M wheels, Bicolour Jet Black, front 9 J x 19 with 255/35 ZR19, rear 10 J x 19 with 275/35 ZR19 tyres.

Exclusively available with M Sport Pro Package.



19" M LIGHT ALLOY DOUBLE-SPOKE STYLE 799 M WHEELS, JET BLACK.

19" M light alloy Double-spoke style 799 M wheels, Jet Black, front 9 J x 19 with 255/35 ZR19, rear 10 J x 19 with 275/35 ZR19 tyres.

Exclusively available with Shadowline Plus.

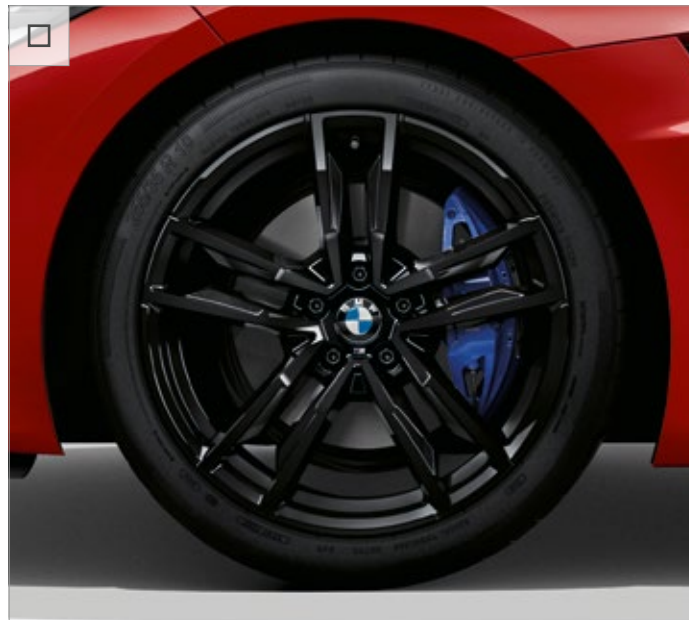

19" LIGHT ALLOY V-SPOKE STYLE 722 M WHEELS, BICOLOUR FERRIC GREY.

19" light alloy V-spoke style 722 wheels, Bicolour Ferric Grey, front 9 J x 19 with 255/35 ZR19, rear 10 J x 19 with 275/35 ZR19 tyres.

Optional on Sport models.



18" LIGHT ALLOY V-SPOKE STYLE 770 WHEELS, BICOLOUR ORBIT GREY.

18" light alloy V-spoke style 770 wheels, Bicolour Orbit Grey, front 8 J x 18 with 225/45 ZR18, rear 9 J x 18 with 255/40 ZR18 tyres.

Standard on Sport models.



18" M LIGHT ALLOY DOUBLE-SPOKE STYLE 798 M WHEELS, BICOLOUR FERRIC GREY.

18" M light alloy Double-spoke style 798 M wheels, Bicolour Ferric Grey, front 8 J x 18 with 225/45 ZR18, rear 9 J x 18, 255/40 ZR18 tyres.

Standard on M Sport models.





# GENUINE BMW ACCESSORIES.

## BMW M PERFORMANCE KEY CASE.

The high-quality BMW M Performance key case is made from Alcantara and protects the key from scratches.



## 18" M LIGHT ALLOY DOUBLE-SPOKE STYLE 798 M WHEELS.

The high-quality 18" M light alloy Double-spoke style 798 wheels are finished in Orbit Grey. They're compatible with snow chains and lend the vehicle a very sporty appearance with an exclusive look.



## FLOATING HUB CAPS.

The Floating Hub Caps consist of the BMW logo that does not turn with the wheel but instead remains level. Two sizes are available, meaning the hub caps can be fitted to most BMW models.



## FLOOR MATS, BLACK.

Precisely fitting protection against moisture and dirt in the front footwell. Featuring a Black design, they perfectly complement the interior.



## 17" LIGHT ALLOY V-SPOKE STYLE 768 WHEELS.

The high-quality 17" light alloy V-spoke style 768 wheels are finished in Ferric Grey. They're compatible with snow chains and lend the vehicle a very sporty appearance with an exclusive look.



## ADVANCED CAR EYE 2.0.

The highly sensitive full-HD Advanced Car Eye 2.0 records automatically in order to capture events as seen from the vehicle, even when it is parked.



Rear camera unavailable for this model.

# PRICING INFORMATION.



sDrive20i Sport	sDrive20i M Sport	sDrive30i Sport	sDrive30i M Sport	M40i
-----------------	-------------------	-----------------	-------------------	------

Basic price (excluding VAT)	£31,083.33	£32,541.67	£34,270.83	£35,729.17	£41,245.83
VAT 20%	£6,216.67	£6,508.33	£6,854.17	£7,145.83	£8,249.17
RRP (including VAT)	£37,300	£39,050	£41,125	£42,875	£49,495
On the road price from	£38,745	£40,495	£42,570	£44,320	£51,270
PI1d value – Automatic	£38,150	£39,900	£41,975	£43,725	£50,345
BIK tax rate (2020 / 2021)	35%	35%	35%	35%	37%
Insurance group	30	31	33	34	37
RDE2 Compliant (Y / N)	Y	Y	Y	Y	Y

## PRICES AND SPECIFICATIONS

BMW (UK) Limited reserves the right to alter prices and specifications without notice. BMW (UK) Limited has made every effort to ensure the accuracy of information but does not accept liability for any errors or omissions.

## VED RATES

Annual VED (second year onwards), for cars costing over £40,000, is payable for five years. VED rates for brand new cars are determined by their CO<sub>2</sub> emissions figure. First year VED applies to the first year of ownership. Annual VED rates apply thereafter. The BMW Z4 models fall into one of the categories listed below:

CO <sub>2</sub> emissions – combined (g/km)	01-50	51-75	76-90	91-100	101-110	111-130	131-150	151-170	171-190	191-225	226-255	Over 255
First year VED (petrol and RDE2 diesel)	£10	£25	£110	£135	£155	£175	£215	£540	£870	£1,305	£1,850	£2,175
Annual VED – second year onwards (standard rate for petrol and diesel cars)	£150	£150	£150	£150	£150	£150	£150	£150	£150	£150	£150	£150
Annual VED – second year onwards (petrol and diesel cars over £40,000)	£475	£475	£475	£475	£475	£475	£475	£475	£475	£475	£475	£475

## ON THE ROAD PRICE

The recommended on the road price includes:

Delivery and BMW Emergency Service	£825
Number plates	£25
Vehicle first registration fee	£55
First year Vehicle Excise Duty	See left

Insurance group figures refer to 50 Group Rating System. Figures shown are for comparability purposes; only compare fuel consumption and CO<sub>2</sub> figures with other cars tested to the same technical procedures. These figures may not reflect real life driving results, which will depend upon a number of factors including the accessories fitted (post-registration), variations in weather, driving styles and vehicle load. The CO<sub>2</sub> figures have been determined according to the WLTP test. WLTP has been used as the applicable CO<sub>2</sub> figure from 1 April 2020 for first year vehicle tax (VED) and from 6 April 2020 for company car tax (BIK). The CO<sub>2</sub> figures were previously based on the NEDC equivalent.

# TECHNICAL INFORMATION.



	sDrive20i Sport	sDrive20i M Sport	sDrive30i Sport	sDrive30i M Sport	M40i
--	-----------------	-------------------	-----------------	-------------------	------

Power output (hp)	197	197	258	258	340
0-62mph / 0-100km/h (secs)	6.6	6.6	5.4	5.4	4.5
Fuel consumption – combined (mpg)*	39.2-39.8	39.2-40.4	39.2-39.8	39.2-39.8	35.3-35.8
Fuel consumption – combined (l/100km)*	7.2-7.1	7.2-7.0	7.2-7.1	7.2-7.1	8.0-7.9
CO <sub>2</sub> emissions – combined (g/km)*	164-161	163-160	164-162	164-161	181

CO<sub>2</sub> value will vary dependent on vehicle specification. Build your BMW and view the CO<sub>2</sub> figure for your chosen model [here](#). \* = Figures shown are for comparability purposes; only compare fuel consumption and CO<sub>2</sub> figures with other cars tested to the same technical procedures. These figures may not reflect real life driving results, which will depend upon a number of factors including the accessories fitted (post-registration), variations in weather, driving styles and vehicle load. The CO<sub>2</sub> figures shown above have been determined according to the WLTP test. WLTP has been used as the applicable CO<sub>2</sub> figure from 1 April 2020 for first year vehicle tax (VED) and from 6 April 2020 for company car tax (BIK). The CO<sub>2</sub> figures were previously based on the NEDC equivalent.

# OPTIONAL EQUIPMENT PRICING.

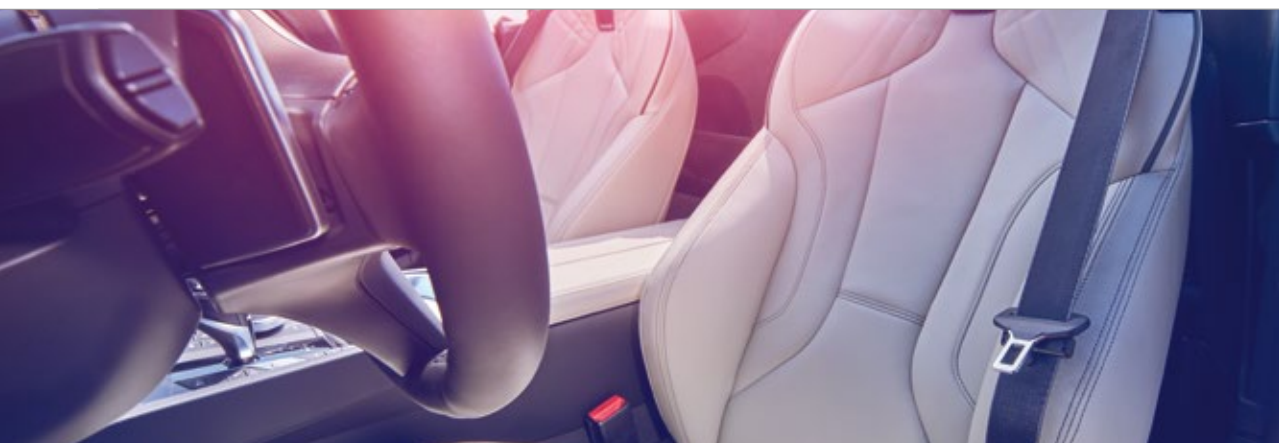

	sDrive20i Sport	sDrive20i M Sport	sDrive30i Sport	sDrive30i M Sport	M40i	Price
--	-----------------	-------------------	-----------------	-------------------	------	-------

## PAINTWORK

Non-metallic Available in Alpine White	■	■	■	■	■	Std
Metallic Available in Black Sapphire, Glacier Silver <sup>1</sup> , Mediterranean Blue <sup>1</sup> , Mineral White <sup>1</sup> , Misano Blue <sup>2</sup> or San Francisco Red	□	□	-	-	-	£670
Available in Frozen Grey	-	-	□	□	□	£0
	-	-	-	□	□	£1,880

## UPHOLSTERY

Vernasca leather with decorative stitching Available in Black, Cognac, Ivory White or Magma Red	■	■	■	■	■	Std
--	---	---	---	---	---	-----

## INTERIOR TRIMS

Aluminium Mesh effect	□	-	□	-	-	£80
	-	□	-	□	□	£0
Aluminium Tetragon	-	■	-	■	■	Std
High-gloss Black	■	□	■	□	□	£0

## BMW EFFICIENT DYNAMICS

Auto Start-Stop	■	■	■	■	■	Std
Brake Energy Regeneration	■	■	■	■	■	Std
ECO PRO mode	■	■	■	■	■	Std
Electric Power Steering (EPS) with Servotronic	■	■	■	■	■	Std
Lightweight Engineering	■	■	■	■	■	Std
Optimum Shift Indicator	■	■	■	■	■	Std
Reduced rolling resistance tyres	■	■	■	■	■	Std

Individual BMW EfficientDynamics features may be excluded, depending on the optional equipment chosen. Your BMW Centre will be pleased to provide you with more information.

<sup>1</sup> = Only available for Sport models. <sup>2</sup> = Only available for M Sport and M40i models.



	sDrive20i Sport	sDrive20i M Sport	sDrive30i Sport	sDrive30i M Sport	M40i	Price
--	-----------------	-------------------	-----------------	-------------------	------	-------

## PACKAGES

Packages provide an intelligent selection of individual options at a lower combined price, as well as contributing to the resale value of the vehicle. Further options can still be specified even when a package is chosen.

<b>COMFORT PACKAGE</b> Comprises: – Comfort Access with smart-opener – Steering wheel heating – Through-loading system – Wind deflector	<input type="checkbox"/>	<input type="checkbox"/>	<input type="checkbox"/>	<input type="checkbox"/>	<input type="checkbox"/>	£750
<b>COMFORT PLUS PACKAGE</b> Comprises: – Comfort Package – Lumbar support, driver and front passenger – Seat adjustment – front, electric with driver memory	<input type="checkbox"/>	<input type="checkbox"/>	<input type="checkbox"/>	<input type="checkbox"/>	-	£1,700
<b>DRIVING ASSISTANT PACKAGE</b> Comprises: – Active Cruise Control with Stop&Go function – Driving Assistant, including: – Approach Control Warning – Crossing-traffic Warning – Lane Change Warning – Lane Departure Warning – Preventive of rear collision – Speed-limit information and no-overtaking indicator	<input type="checkbox"/>	<input type="checkbox"/>	<input type="checkbox"/>	<input type="checkbox"/>	<input type="checkbox"/>	£900
<b>M SPORT PRO PACKAGE</b> Comprises: – 19" M Double-spoke style 799 M wheels, Bicolour Jet Black – Adaptive M suspension – Exterior trim, Extended High-gloss Shadowline – M seat belts – M Sport braking system (sDrive20i only) – M Sport differential (sDrive30i only)	-	<input type="checkbox"/>	-	<input type="checkbox"/>	-	£1,950
<b>SHADOWLINE PLUS</b> Comprises: – 19" M Double-spoke style 799 M wheels, Jet Black – Exterior trim, Extended High-gloss Shadowline – Mirror caps, Black	-	-	-	-	<input type="checkbox"/>	£500
<b>TECHNOLOGY PACKAGE</b> Comprises: – Enhanced Bluetooth with wireless charging – Head-up Display – Loudspeaker system – harman/kardon – Parking Assistant – WiFi hotspot preparation	<input type="checkbox"/>	<input type="checkbox"/>	<input type="checkbox"/>	<input type="checkbox"/>	<input type="checkbox"/>	£1,800



	sDrive20i Sport	sDrive20i M Sport	sDrive30i Sport	sDrive30i M Sport	M40i	Price
--	-----------------	-------------------	-----------------	-------------------	------	-------

PACKAGES (CONT.)

<b>VISIBILITY PACKAGE</b> Comprises: – Adaptive LED headlights – High-beam Assistant	<input type="checkbox"/>	<input type="checkbox"/>	<input type="checkbox"/>	<input type="checkbox"/>	<input type="checkbox"/>	£900
---	--------------------------	--------------------------	--------------------------	--------------------------	--------------------------	------

STEERING & CHASSIS

<b>Active Guard</b> Comprises: – Front collision warning with brake intervention – Lane Departure Warning with steering impulse – Speed Limit Assist	<input checked="" type="checkbox"/>	<input checked="" type="checkbox"/>	<input checked="" type="checkbox"/>	<input checked="" type="checkbox"/>	<input checked="" type="checkbox"/>	Std
--	-------------------------------------	-------------------------------------	-------------------------------------	-------------------------------------	-------------------------------------	-----

SAFETY & TECHNOLOGY

<b>Parking Assistant</b> Comprises: – Lateral parking aid – Rear-view camera – Reversing Assistant	<input type="checkbox"/>	<input type="checkbox"/>	<input type="checkbox"/>	<input type="checkbox"/>	<input type="checkbox"/>	£500
--	--------------------------	--------------------------	--------------------------	--------------------------	--------------------------	------

SEATS

Lumbar support, driver and front passenger	<input type="checkbox"/>	<input type="checkbox"/>	<input type="checkbox"/>	<input type="checkbox"/>	<input checked="" type="checkbox"/>	£265
Through-loading system	<input type="checkbox"/>	<input type="checkbox"/>	<input type="checkbox"/>	<input type="checkbox"/>	<input type="checkbox"/>	£100

EXTERIOR EQUIPMENT

Soft top, Anthracite Silver	<input type="checkbox"/>	<input type="checkbox"/>	<input type="checkbox"/>	<input type="checkbox"/>	<input type="checkbox"/>	£250
Wind deflector	<input type="checkbox"/>	<input type="checkbox"/>	<input type="checkbox"/>	<input type="checkbox"/>	<input type="checkbox"/>	£170

INTERIOR EQUIPMENT

Steering wheel heating	<input type="checkbox"/>	<input type="checkbox"/>	<input type="checkbox"/>	<input type="checkbox"/>	<input type="checkbox"/>	£170
------------------------	--------------------------	--------------------------	--------------------------	--------------------------	--------------------------	------



	sDrive20i Sport	sDrive20i M Sport	sDrive30i Sport	sDrive30i M Sport	M40i	Price
--	-----------------	-------------------	-----------------	-------------------	------	-------

## AUDIO & COMMUNICATION

BMW Emergency Call <sup>1</sup>	■	■	■	■	■	Std
BMW Live Cockpit Professional Comprises: – 10.25" Control Display with Touch Functionality – 10.25" Digital Instrument Display – BMW Intelligent Personal Assistant <sup>2</sup> – BMW Operating System 7.0 – iDrive Controller with Touch Function – Intelligent Functionalities <sup>2,3</sup> – Remote Software Upgrade <sup>2</sup> For further details, see <a href="#">BMW ConnectedDrive</a>	■	■	■	■	■	Std
BMW Online Services <sup>2,3</sup> Comprises: – BMW Apps – BMW Online Services – Last State Call <sup>1,2</sup> – USB and Over-the-air Map Updates	■	■	■	■	■	Std
BMW TeleServices <sup>1</sup>	■	■	■	■	■	Std
Connected Package Professional <sup>2,3</sup> Comprises: – BMW Maps – Concierge Services – Connected Music – Connected Parking – Connected Teaser – In-Car Experiences – Real Time Traffic Information – Remote Services – Smartphone Integration <sup>1,6</sup> For further details, see <a href="#">BMW ConnectedDrive</a>	■	■	■	■	■	Std
Enhanced Bluetooth with wireless charging	□	□	□	□	□	£350
WiFi hotspot preparation <sup>7</sup> Only with Enhanced Bluetooth with wireless charging	□	□	□	□	□	n/a





Only with = these options must be ordered together. <sup>1</sup> = Available and active without runtime limitations. Usage cannot be guaranteed permanently due to potential future technical developments (of the Service availability and/or Smartphone compatibility/operating systems). <sup>2</sup> = Requires a free BMW ConnectedDrive account. <sup>3</sup> = Active for 3 years, renewable thereafter at an additional cost. <sup>4</sup> = Includes BMW Music for a three month trial. For further details, see [BMW ConnectedDrive](#). <sup>5</sup> = Available and active for three months. Can be extended or renewed thereafter at an extra cost. <sup>6</sup> = Functions using a data connection will use data from the SIM card in the phone. Additional data charges may be applied by the mobile network provider. Compatibility and functions may vary due to the make and model year of the phone and the version of software installed on it. <sup>7</sup> = Data subscription costs apply and must be purchased separately.

■ Standard equipment □ Optional equipment - Not available



sDrive20i Sport	sDrive20i M Sport	sDrive30i Sport	sDrive30i M Sport	M40i	Price
-----------------	-------------------	-----------------	-------------------	------	-------

LIGHT ALLOY WHEELS

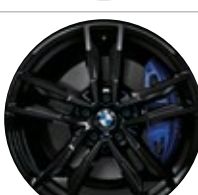
	18" V-spoke style 770, Bicolour Orbit Grey	■	-	■	-	-	Std
	18" M Double-spoke style 798 M, Bicolour Ferric Grey	-	■	-	■	-	Std
	19" V-spoke style 772, Bicolour Ferric Grey	□	-	□	-	-	£850
	19" M Double-spoke style 800 M, Bicolour Cerium Grey	-	-	-	-	■	Std
	19" M Double-spoke style 799 M, Bicolour Jet Black	-	□	-	□	-	n/a
	19" M Double-spoke style 799 M, Jet Black Only with Shadowline Plus	-	-	-	-	□	n/a

See [Wheels & Tyres](#) for further details. Only with = these options must be ordered together.

■ Standard equipment □ Optional equipment - Not available



# DIMENSIONS.

## THE BMW Z4.

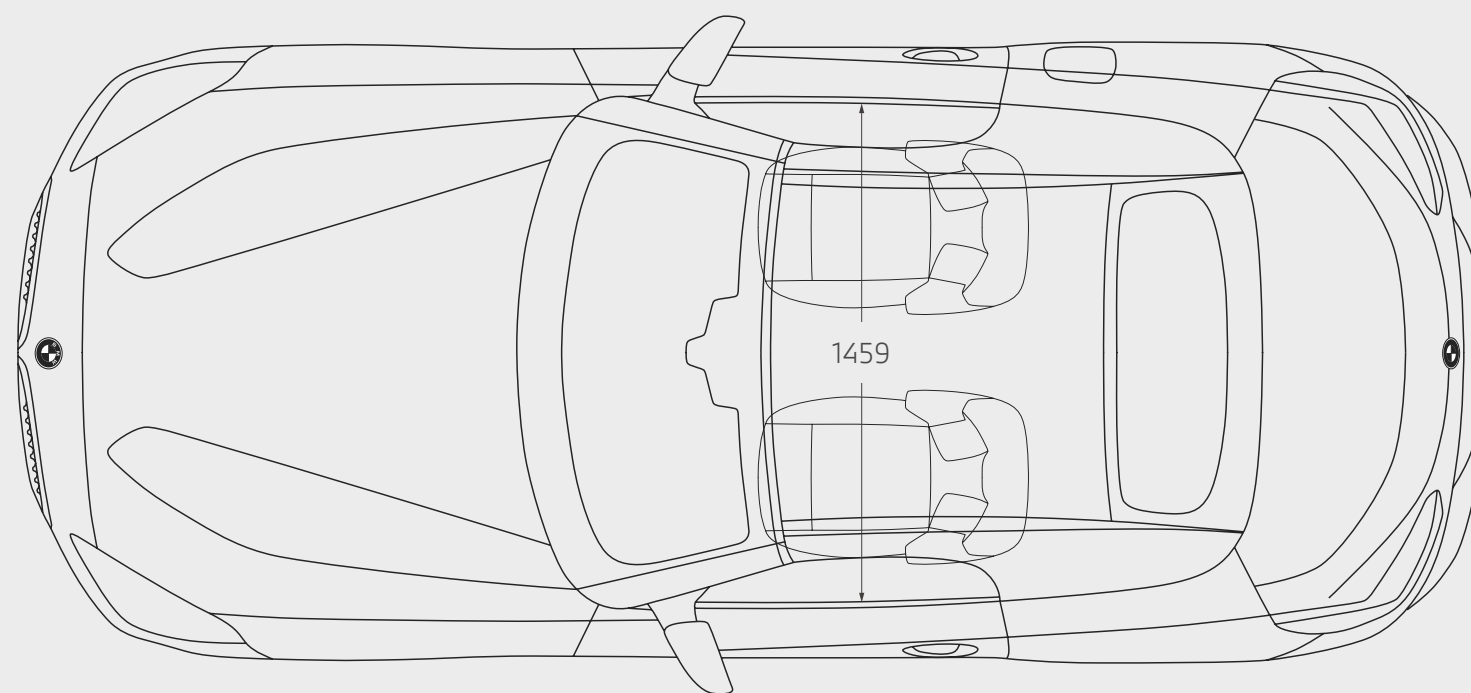
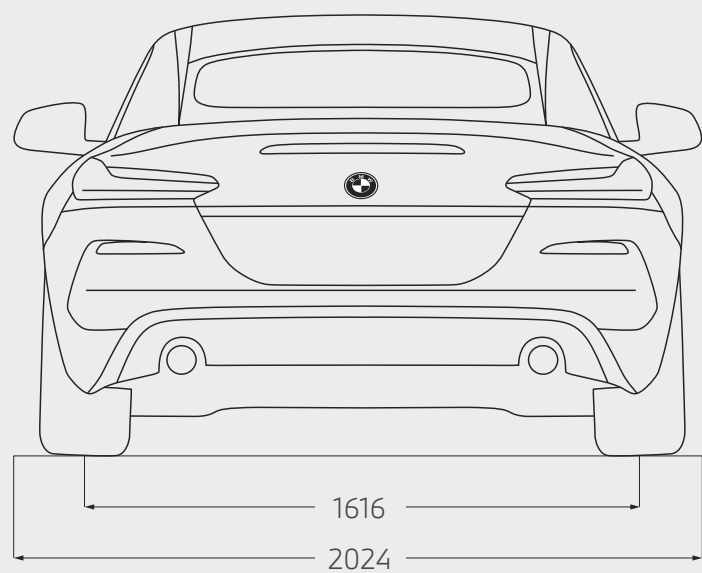
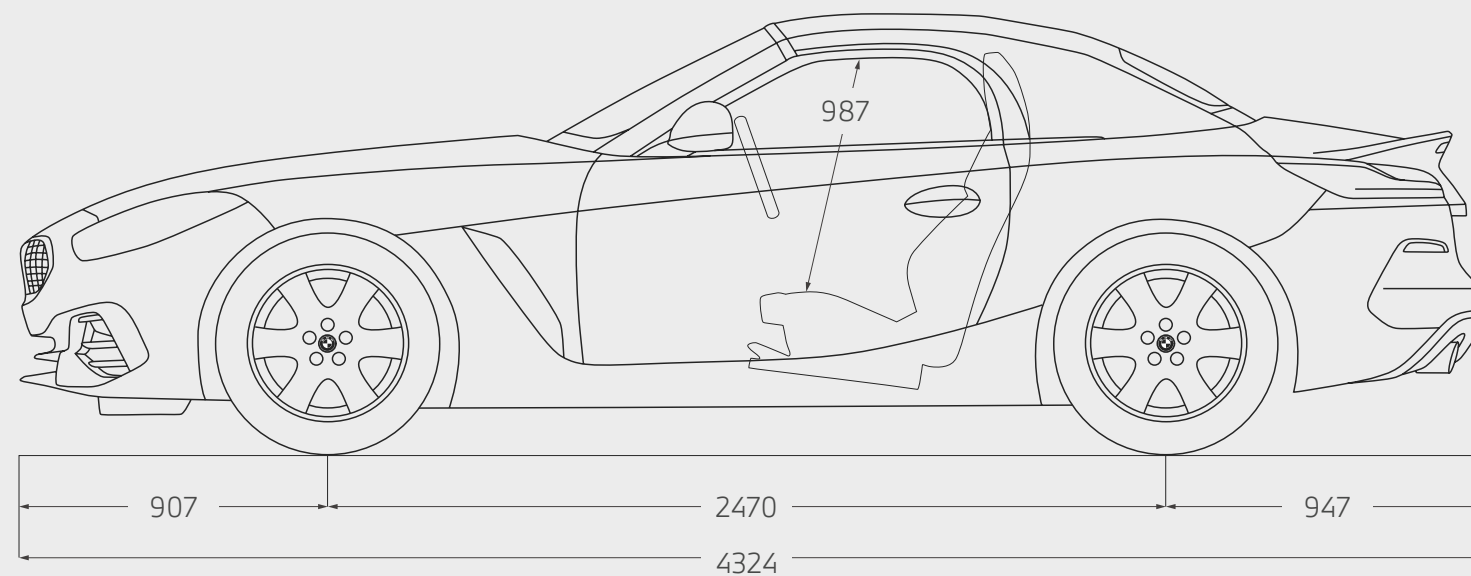
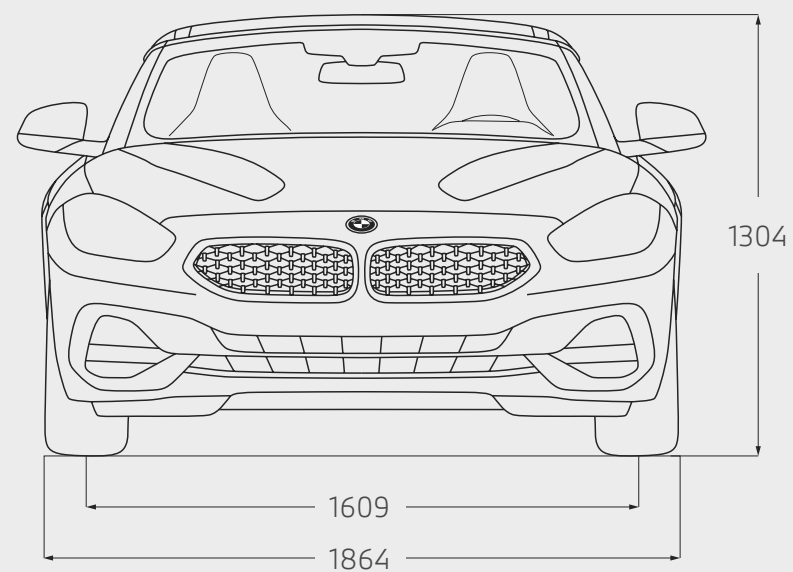

Length (mm)	4324	Height (mm)	1304	Number of seats	2	Turning circle (m)	11.0
Width (mm)	1864	Width including mirrors (mm) (Driver / Passenger)	2024 (1018 / 1006)	Wheelbase (mm)	2470	Luggage capacity (litre)	281

# BMW PAY MONTHLY SERVICING & TRACKSTAR.

## SERVICING MADE SIMPLE.

Planning for the road ahead has never been easier. With the BMW Pay Monthly Service Plan<sup>1</sup> you can remove the uncertainty often associated with car servicing costs by spreading them monthly, much like you would your household bills. Our Pay Monthly service plan covers two services and any unused credit can be transferred to another BMW if you decide to switch unexpectedly. As part of the Pay Monthly plan you will also receive a number of added extras including:

- Fluid top ups
- An MOT
- A Wash & Vac each time you visit
- Seasonal health checks
- Sat Nav Map updates

Get the quality service and parts you expect from BMW with a fixed monthly payment. Give your BMW the care and attention it deserves from the experts that made it.

**Price: £25 per month for 36 months**

Please contact your preferred BMW Centre for further information.

## BMW TRACKSTAR.

Locate and recover your vehicle if it is stolen with BMW Trackstar or BMW Trackstar Advance. Benefits include:

- 24/7 Trackstar Monitoring Centre
- Thatcham accredited
- Integrated motion sensor
- Pan-European protection

**BMW Trackstar S7 price from: £399<sup>2</sup>**

**BMW Trackstar S5 price from £549<sup>2</sup>**

**BMW Trackstar S5 Advance price from: £649<sup>2</sup>**



# BMW CONNECTED DRIVE SERVICES.

BMW ConnectedDrive keeps driver and vehicle connected with the outside world. Digital services, driver-focused technologies and driver assistance systems provide more comfort, more entertainment and more safety. Increase your driving pleasure – with BMW ConnectedDrive.

For further information on BMW ConnectedDrive and the General Terms and Conditions of Service for ConnectedDrive, please see: [www.bmw.co.uk/connecteddrive-information](http://www.bmw.co.uk/connecteddrive-information)

The BMW ConnectedDrive Hotline is available on: +44 (0) 800 561 0555 from Monday to Friday 8am – 7pm and Saturday to Sunday 9am – 5pm.

## CONNECTED DRIVE SERVICES DURATION

BMW Music	3 month trial
BMW Apps	3 years
BMW Intelligent Personal Assistant	3 years
BMW Maps	3 years
BMW Online Services	3 years
Concierge Services	3 years
Connected Music	3 years
In-Car Experiences	3 years
Intelligent Functionalities	3 years
Map Updates	3 years
Real Time Traffic Information	3 years
Remote Services	3 years
Remote Software Upgrade	3 years
BMW Emergency Call	Active without runtime limitations
BMW TeleServices	Active without runtime limitations
Last State Call	Active without runtime limitations
Smartphone Integration	Active without runtime limitations

## GENERAL INFORMATION

BMW (UK) Ltd, Summit ONE, Summit Avenue, Farnborough, Hampshire, GU14 0FB (hereinafter referred to as "BMW") provides the customer with certain vehicle-related information and assistance functions (hereinafter called "Services") under the name of "BMW ConnectedDrive". BMW collects, stores or processes car-related data in compliance with applicable law and only to the extent necessary to provide the Services. BMW does not collect, store or process personal data in course of the Services – except where this is explicitly stated in the service description of the individual Services. In the case of Services that require personal data to be collected, stored and processed so that such Services can actually be provided, BMW informs customers of this in advance by providing this data protection notice. The Services are provided by means of a SIM card installed in the vehicle.

## DEACTIVATION

You can have the BMW ConnectedDrive services deactivated through an authorised BMW centre, a BMW subsidiary or a BMW authorised workshop at any time. This also has the consequence that aspects of the emergency call in the vehicle as well as all remaining Services will no longer function.

You can additionally arrange for the remaining Services to be deactivated via "My BMW ConnectedDrive".

If the vehicle is equipped with the legally required EU Emergency Call (as from April 2018) a deactivation of the BMW ConnectedDrive basic services will not deactivate the vehicle's built-in SIM card. It has to remain active, so that the EU Emergency Call is functional all the time.

Services that are available and active without runtime limitations, cannot be guaranteed for permanent usage due to potential future technical developments (of the Service availability and/or Smartphone compatibility/operating systems).





READY TO TAKE THE NEXT STEP?

