

# RANGE ROVER



ABOVE & BEYOND



**ENTER**  
scroll or swipe to interact



**ABOVE & BEYOND**

Ever since the first Land Rover vehicle was conceived in 1947, we have built vehicles that challenge what is possible. These in turn have challenged their owners to explore new territories and conquer difficult terrains. Our vehicles epitomise our brand. Vehicles with exemplary design credentials and engineering capabilities. Which is how we continue to break new ground, defy conventions and encourage each other to go further. Land Rover truly enables you to make more of your world, to go above and beyond.



DESIGN

PERFORMANCE

CAPABILITY

TECHNOLOGY

SAFETY

VERSATILITY

PERSONALISATION

# RANGE ROVER

 BUILD YOUR OWN

Reflecting its unrivalled heritage, Range Rover takes design, comfort and craftsmanship to extraordinary new heights. As striking on the outside as it is refined within, its performance and capability are peerless. Exemplary levels of comfort and technology bring you a heightened sense of effortless sophistication and a truly first-class travel experience.



DESIGN

PERFORMANCE

CAPABILITY

TECHNOLOGY

SAFETY

VERSATILITY

PERSONALISATION

## RANGE ROVER WESTMINSTER

Range Rover Westminster and Westminster Black are pure expressions of design, engineering and craft. Whichever you own, it will deliver exemplary levels of sophistication and capability.



Vehicles shown are from the Land Rover global range. Specifications, options and availability will vary between markets and should be verified with your nearest Land Rover Retailer. CO<sub>2</sub> and fuel economy figures may vary according to wheel fitment and optional extras fitted.

Vehicle shown is Westminster Edition in Portofino Blue with optional features fitted.



DESIGN

PERFORMANCE

CAPABILITY

TECHNOLOGY

SAFETY

VERSATILITY

PERSONALISATION

# EXTERIOR

With its floating roof, continuous waistline and lower accents, Range Rover's silhouette is recognised around the world. Those commanding looks have been given an even more contemporary profile. The front grille signals a more prominent appearance, whilst the clamshell bonnet, formed of a single sheet of aluminium, is now smoother and longer to augment the vehicle's more formal, upright profile.



Vehicle shown is Autobiography in Byron Blue with optional features fitted.



**DESIGN**

**PERFORMANCE**

**CAPABILITY**

**TECHNOLOGY**

**SAFETY**

**VERSATILITY**

**PERSONALISATION**

The front bumper - including vent finishers, side vent graphics, side accent graphics and integrated exhausts - helps advance the vehicle's effortless design. A choice of Atlas or Satin body-coloured side graphics, optional design packs and new wheel designs add further appeal, whilst the option of striking Pixel-laser headlights (see page 45) and rear LED lights reinforce the vehicle's distinctive features.



DESIGN

PERFORMANCE

CAPABILITY

TECHNOLOGY

SAFETY

VERSATILITY

PERSONALISATION

# INTERIOR

Sumptuously designed, Range Rover's interior is a tranquil haven. Effortlessly comfortable, superbly appointed and finished with a forensic eye for the details, every facet of the interior has been designed and engineered to deliver class-leading comfort for all occupants.

Actual seats have new cushions and interlayers with softer, looser leather to optimise these features. Please refer to your Land Rover Retailer for more information.

Interior shown is Autobiography in Navy/Ivory with optional features fitted.





DESIGN

PERFORMANCE

CAPABILITY

TECHNOLOGY

SAFETY

VERSATILITY

PERSONALISATION



Thanks to Range Rover's unique Command Driving Position, the driver continues to enjoy an enhanced view of the road ahead, but now does so in even greater comfort than before. Cossetted in premium materials such as Semi-Aniline\* leather, wide seats and deep cushioning with soft foam interlayers help create the most luxurious environment. Combined with enhanced seat functionality, including the optional upper seat shoulder support and 'hot stone' massage, along with intuitive controls using the door-mounted seat control switches, the interior of Range Rover is the ultimate in refinement.

Seamlessly integrated technologies built around the Touch Pro Duo Touchscreens and Interactive Driver Display embody our design ethos: cleaner, crisper lines and fewer dials - delivering an uncluttered console that doesn't distract the driver. Veneers and luxury finishers amplify the vehicle's refined design cues, whilst enhanced Configurable Ambient Interior Lighting with a choice of 10 colours adds greatly to the overall sense of calm. Additional integrated stowage solutions - including a centre console deep stowage compartment, and other optional features such as the front centre console refrigerator compartment - confirm a purity of craft everywhere you look and touch.

No matter how far you travel in a Range Rover, you'll always arrive as refreshed as when you set out. It's not where you go, it's how you get there.



\*Model dependent.



DESIGN

PERFORMANCE

CAPABILITY

TECHNOLOGY

SAFETY

VERSATILITY

PERSONALISATION

Everyone who travels in Range Rover does so in the utmost comfort and style. Refinement is everywhere you look and in everything you touch; nothing exemplifies this better than the rear Executive Class seating, standard on Autobiography.

As with the front, the rear also features wider seats with deeper cushioning. The rear Executive Class seats take this to another level. When lowered, a power deployable centre console with premium veneer finishers and clever stowage solutions integrates seamlessly with the two outer passenger seats, creating a luxury four-seat environment. And at the touch of a button, Extreme Passenger Seat Away will adjust the front passenger seat forward to maximise the rear passenger's space and forward visibility, whilst the extended recline and integrated side cushions mean the passenger can adjust their seat into their optimum position.

Optional Executive Class Comfort features, including adjustable bolsters, upper seat shoulder support, headrest pillows and 'hot stone' massage, further enhance the rear passenger's journey. Whilst additional Executive Class Comfort Plus features - such as heated armrests, heated calf rest and a footrest with a dedicated area to warm your feet - create a truly luxurious environment.

Interior shown is Autobiography Long Wheelbase in Ebony/Vintage Tan with optional features fitted.



When you require increased versatility, simply retract the power deployable centre console to reveal a centre seat for a third occupant. Or, fold your rear Executive Class seats forward. You can do so even when you're not in the vehicle using the Remote Intelligent Seat Fold application.

Other available features include optional Rear Seat Entertainment with 10" Touchscreens, Connect Pro connectivity with 4G Wi-Fi and Comfort Controller Remote App, for greater control of features such as seat massage, heating and cooling, and personal climate settings. Enhanced task lighting is provided as standard and comes with user selectable modes, including a bright light and a warm light setting for a more relaxed environment, making Range Rover the perfect partner for your journey.



REAR EXECUTIVE CLASS SEATING WITH POWER DEPLOYABLE CENTRE CONSOLE STOWED.



REAR EXECUTIVE CLASS SEATING WITH POWER DEPLOYABLE CENTRE CONSOLE DEPLOYED.



DESIGN

PERFORMANCE

CAPABILITY

TECHNOLOGY

SAFETY

VERSATILITY

PERSONALISATION

# RANGE ROVER LONG WHEELBASE

 BUILD YOUR OWN

Range Rover Long Wheelbase is instantly recognisable, superbly engineered and beautifully appointed. Featuring a panoramic roof as standard, this body style is characterised by a distinctive 'L' badge mounted behind each front wheel arch. The exterior is extended by 200mm to facilitate an even more luxurious environment inside. The definitive luxury SUV, Range Rover Long Wheelbase has an additional 192mm of interior floorspace for even more passenger legroom and comfort.

Standard features include an added deep centre stowage compartment at the rear of the front centre console, electric rear side window sunblinds, Configurable Ambient Interior Lighting and illuminated treadplates. With features such as Four-zone Climate Control to enable personalised temperature control through an additional climate unit, and optional Cabin Air Ionisation with PM2.5 filter\* to improve the air quality within the cabin, passengers in Range Rover Long Wheelbase can create their own tranquil haven.



\*Model dependent.

Vehicle shown is Autobiography Long Wheelbase in Aruba with optional features fitted.



DESIGN

PERFORMANCE

CAPABILITY

TECHNOLOGY

SAFETY

VERSATILITY

PERSONALISATION

Select the rear Executive Class Comfort Plus seats and not only do you get all the luxury features of the Standard Wheelbase, including Extreme Passenger Seat Away, heated armrests and 'hot stone' massage, you also get an additional heated calf rest - one for each side behind both driver and passenger.

And as with every Range Rover, the superbly crafted space is accompanied by the discerning use of the finest materials. In Range Rover Long Wheelbase, every last detail combines to deliver the highest levels of luxury and refinement.

Actual seats have new cushions and interlayers with softer, looser leather to optimise these features. Please refer to your Land Rover Retailer for more information.

 BUILD YOUR OWN



# PERFORMANCE

## ENGINES AND TRANSMISSION

All engines are equipped with Stop/Start technology and smart regenerative solutions to capture wasted kinetic energy when the vehicle is decelerating to reduce fuel consumption, especially during urban driving. Ingenium technology underpins the 6-cylinder petrol and diesel engines in the range. These low-friction, all-aluminium engines have stiff cylinder blocks and twin balancer shafts to ensure inherently low levels of vibration, enabling a smooth and refined driving experience.

## 8-SPEED AUTOMATIC TRANSMISSION

All diesel and petrol engines in Range Rover are coupled with an 8-speed Automatic Transmission. With eight closely spaced ratios, the transmission ensures that you are always in the optimum gear, maximising fuel efficiency and acceleration. Gear changes are almost imperceptible and shift schedules intelligently adapt to your driving style.



DESIGN

PERFORMANCE

CAPABILITY

TECHNOLOGY

SAFETY

VERSATILITY

PERSONALISATION

## PLUG-IN HYBRID ELECTRIC VEHICLE

P400e uses the combination of an advanced 2.0 litre 300HP Si4 Ingenium Petrol engine supported by a high-capacity 105kW electric motor to deliver a combined output of 404HP. The electric motor can either supply its power in parallel with the engine, or drive the vehicle in the manually selectable Electric Vehicle (EV) Mode. The large 13kWh capacity battery gives the vehicle an all-electric range from a full charge, capable of managing most city commutes\* with zero tailpipe emissions. Capability, performance and cutting-edge technologies are at the heart of every Land Rover. Taking our vehicles into the future, electric power now propels us into an exciting new era.

Our Plug-in Hybrid Electric Vehicle (PHEV) is driven by our most innovative powertrain yet: an advanced Ingenium Petrol engine and electric motor combine to give a composed and luxurious ride, with full Range Rover capability\*. With a full electric charge, PHEV is capable of managing most city commutes. Drivers can select from two driving modes to best suit their needs. See pages 18-20 for details.

\*Please refer to the accompanying Technical Specification for full details on driveline, engine performance and fuel economy. Note that CO<sub>2</sub> and fuel economy figures can vary according to wheel fitment, and the lowest figures may not be achievable with the standard wheels.



**Parallel Hybrid Mode** (the default driving mode) - Combined petrol and electric drive. When in Parallel Hybrid Mode, the driver can optimise battery charge or fuel economy by utilising two alternative charge management functions:

**SAVE function** - Prevents the battery charge dropping below the level which has been selected.

**Predictive Energy Optimisation (PEO) function** - By entering a destination in the navigation system, the driver enables the feature, which utilises altitude data for the route selected to intelligently switch between the electric motor and petrol engine to maximise fuel economy.

**EV Mode (Electric Vehicle)** - Full electric drive\*.

In addition to the benefits described above, an increasing number of major cities are introducing vehicle restrictions and charges from which drivers of PHEV vehicles could be exempt.

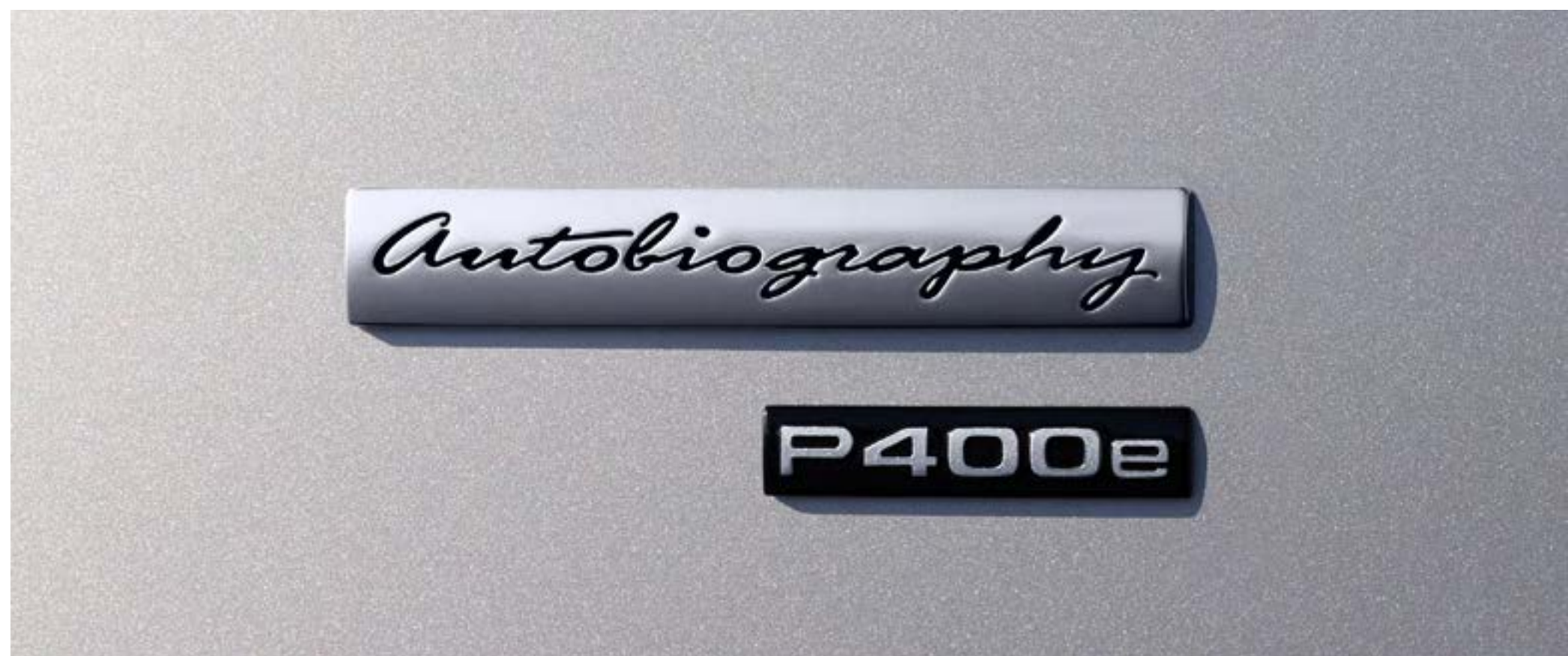

\*Parallel Hybrid Mode will be automatically re-engaged should the driver require more power and torque than is available, or the battery charge drops to an insufficient level to maintain progress.



**Seamless Design** - Integrating the charging port into the front grille provides easy connection without compromising the vehicle's iconic design.

**Low CO<sub>2</sub> Emissions<sup>1</sup>** - PHEV's CO<sub>2</sub> emissions make it one of our lowest emission powertrains yet.

**EV Range** - PHEV is fully capable of managing most city commutes in full Electric Vehicle (EV) Mode<sup>2</sup>.

**Refined Drive** - Our quietest Range Rover yet, PHEV delivers a virtually silent drive in full EV Mode. PHEV ensures seamless transition between the petrol engine and electric motor, delivering optimal refinement.

**No Compromise on Capability and Performance** - PHEV is precise and uncompromising. It is fully capable of handling off-road situations such as wading<sup>3</sup> and rock crawl. Its on-road performance is equally remarkable, delivering additional power when you need it most through a combination of electric motor and petrol engine.

**Cabin Pre-conditioning** - You can pre-heat or, uniquely to PHEV, pre-cool the cabin before you get into the vehicle without starting the engine, making life that bit more comfortable.



<sup>1</sup>Please refer to the accompanying Technical Specification for full details on driveline, engine performance and fuel economy. Note that CO<sub>2</sub> and fuel economy figures can vary according to wheel fitment, and the lowest figures may not be achievable with the standard wheels. <sup>2</sup>Parallel Hybrid Mode will be automatically re-engaged should the driver require more power and torque than is available, or the battery charge drops to an insufficient level to maintain progress. <sup>3</sup>Wading is only available when engine is engaged.

**Easy Overnight Charging** - PHEV can fully charge from a domestic electricity supply in as little as 7.5 hours<sup>1</sup> so it's ideally suited to charging at home overnight.

**Charging Solutions** - A full charge can be achieved in as little as 2.75 hours<sup>1</sup> at home using a 32 amp industrial type socket, or dedicated wall box. In addition, a range of charging points can be used at offices and other designated public places. The Public charging cable (Mode 3) comes as standard with PHEV.

**InControl Connectivity** - With the Protect and Remote Premium<sup>2</sup> features, a range of functions are available through your smartphone device, from enabling the driver to view charge status, to remote operation of the vehicle's climate systems.

<sup>1</sup>Charging times will vary by power supply and charging solution. Please refer to [landrover.co.uk](http://landrover.co.uk) for further information.

<sup>2</sup>Land Rover Remote contains subscription services that can be extended after the initial term advised by your Land Rover Retailer. The Land Rover Remote App will need to be downloaded from the Apple App Store/Google Play Store.



DESIGN

PERFORMANCE

CAPABILITY

TECHNOLOGY

SAFETY

VERSATILITY

PERSONALISATION

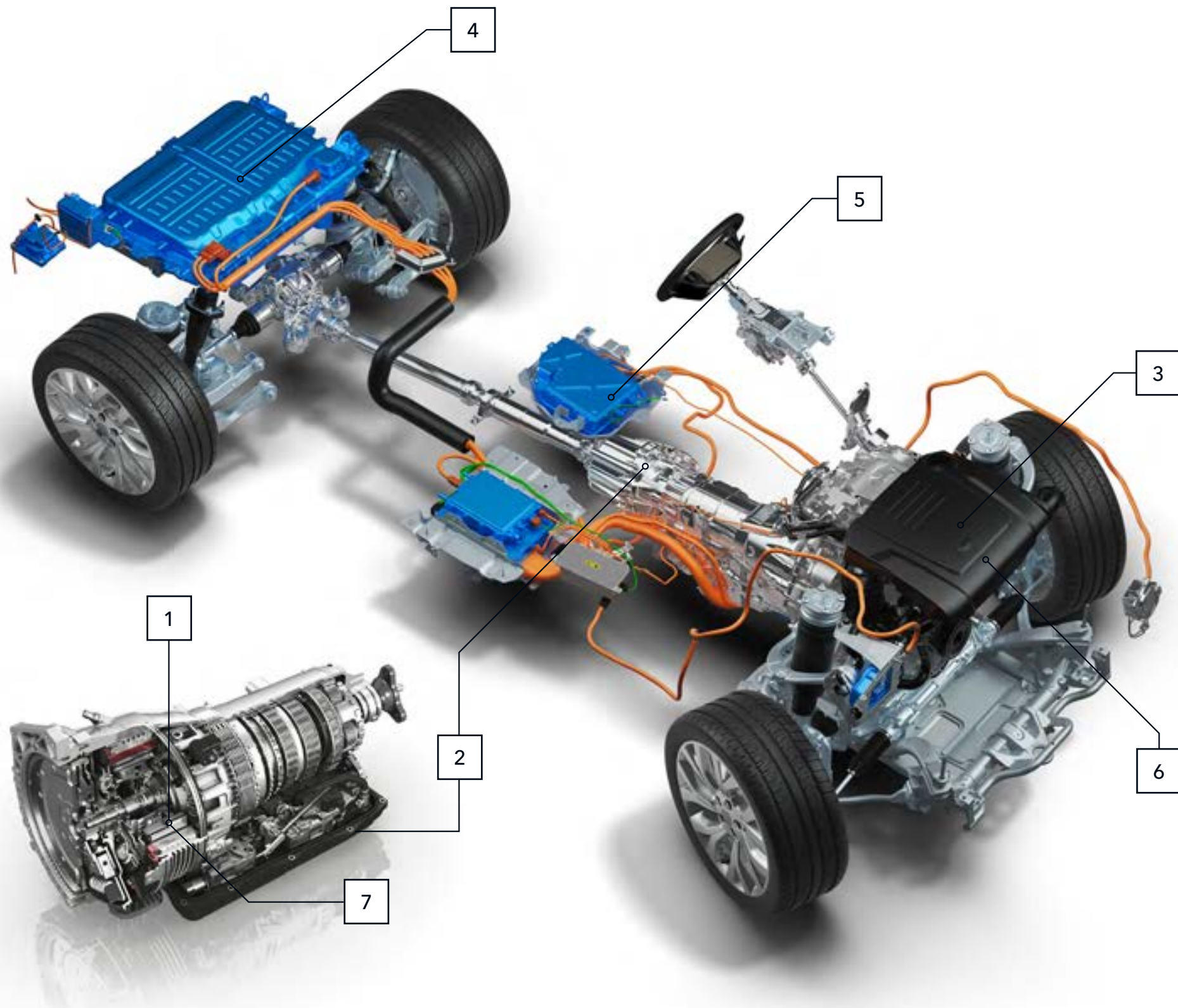

- 1 105KW ELECTRIC MOTOR**  
 PHEV features a high-power 105kW permanent magnet synchronous electric motor to deliver power effortlessly.
- 2 INTEGRATED HYBRID AUTOMATIC TRANSMISSION**  
 A seamless transition from EV to Internal Combustion Engine is delivered via the hybrid integrated transmission.
- 3 2.0 LITRE INGENIUM ENGINE**  
 Developed and engineered by Jaguar Land Rover, our aluminium 2.0 litre 300HP Si4 Ingenium Petrol engine is lighter and more efficient than predecessors.
- 4 13KWH HIGH-VOLTAGE BATTERY**  
 The large capacity battery gives the vehicle an all-electric range, capable of managing most short commutes<sup>1</sup> from a full charge.
- 5 7KW ONBOARD CHARGER**  
 The powerful 7kW onboard charger can deliver a full battery charge in as little as 2.75 hours<sup>2</sup>, dependent on charging station capability.
- 6 INTEGRATED STARTER GENERATOR**  
 The Integrated Starter Generator (ISG) delivers an exceptionally refined starting of the petrol engine when required.
- 7 REGENERATIVE BRAKING**  
 Regenerative braking uses the electric motor to harvest kinetic energy whilst braking, converting it to electrical energy that is used to recharge the high-voltage battery.

<sup>1</sup>Please refer to the accompanying Technical Specification for full details on driveline, engine performance and fuel economy. Note that CO<sub>2</sub> and fuel economy figures can vary according to wheel fitment, and the lowest figures may not be achievable with the standard wheels. <sup>2</sup>Charging times will vary by power supply and charging solution. Please refer to [landrover.co.uk](http://landrover.co.uk) for further information.

## MILD HYBRID ELECTRIC VEHICLE

Land Rover is at the forefront of sustainable innovation. Taking our vehicles into a smarter and more exciting future, Mild Hybrid Electric Vehicle (MHEV) technology is a system that uses a belt-driven starter generator and state-of-the-art 48V battery. These harvest energy that would normally be lost during deceleration, which is then intelligently redeployed.

The stored electricity can be used by the starter-generator to provide torque assistance to the engine directly, or to power the electric Supercharger on P400 engine to boost performance before the conventional Turbocharger reaches its maximum output, giving seamless throttle response. This system helps improve fuel economy and boosts the vehicle's performance.

The combination of MHEV technology, together with other detailed efficiency improvements, lower the CO<sub>2</sub> emissions of the Ingenium In-line 6-cylinder engines substantially, when compared to the outgoing engine. The MHEV technology is standard with D300<sup>2</sup>, D350 and P400 engines.

- 1 48V ELECTRIC SUPERCHARGER<sup>1</sup>
- 2 TWIN-SCROLL TURBOCHARGER
- 3 48V LITHIUM-ION BATTERY
- 4 BELT-DRIVEN INTEGRATED STARTER GENERATOR
- 5 48V/12V DC-DC CONVERTER
- 6 12V BATTERY

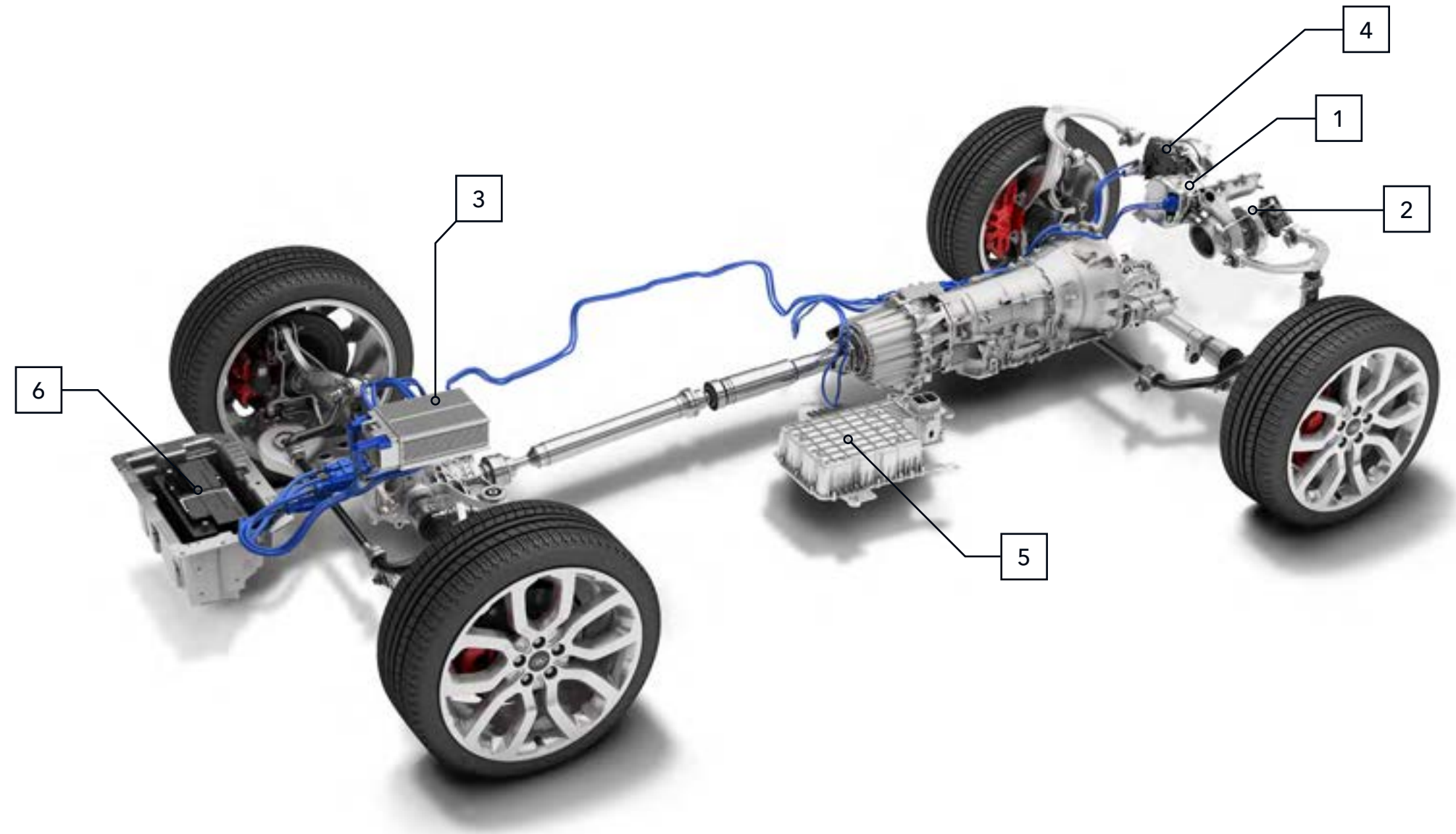

<sup>1</sup>Engine dependent. <sup>2</sup>Only available on SWB.



DESIGN

PERFORMANCE

CAPABILITY

TECHNOLOGY

SAFETY

VERSATILITY

PERSONALISATION

# LEGENDARY BREADTH OF CAPABILITY

Range Rover continues to offer outstanding capability on and off-road, with permanent All Wheel Drive (AWD), twin-speed transmission, Adaptive Dynamics and electronic centre differential as standard, whilst Land Rover's revolutionary Terrain Response system means this capability can be harnessed by all drivers, expert and inexperienced alike. This extraordinary capability can be extended to suit individual requirements with a range of additional, optional all-terrain technologies.



## ELECTRONIC AIR SUSPENSION

A sure-footed, composed drive is completed by the latest Electronic Air Suspension, which provides exceptional wheel articulation and poise. It changes the vehicle's height quickly, allowing cross linking of the diagonal wheels to keep all four wheels on the ground on very uneven surfaces. Added to which, it makes loading heavy objects into the boot easier, as you can lower the vehicle's rear suspension height by up to 50mm to suit your needs. These functions can be operated via the 10" Touchscreen, a button in the loadspace area or remotely via the key fob.

Range Rover has a choice of ride height settings to assist the driver and passengers of the vehicle at different stages of their journey or across various terrains - from an access height of 50mm below normal ride height, to an extended height of up to 75mm, with a further extended ride height of up to an additional 80mm in more extreme off-road conditions.

The Speed Lowering system uses the Electronic Air Suspension to reduce aerodynamic drag and fuel consumption at cruising speeds, by lowering the vehicle by 15mm from normal ride height when the speed reaches 65mph.

## TWIN-SPEED TRANSFER BOX WITH ELECTRONIC CENTRE DIFFERENTIAL

An additional set of lower gears can prove invaluable in challenging conditions such as steep inclines or declines, off-road driving or when towing. The twin-speed transfer box system gives you precise speed and control in such instances. The heart of the twin-speed system is the electronic centre differential that offers a 50:50 torque split between front and rear axles, with the ability to pre-emptively lock the axles before slip commences.

## TERRAIN RESPONSE

When you manually select Land Rover's unique standard Terrain Response system, it sets the vehicle up optimally to match the demands of the terrain, by adapting the responses of the vehicle's engine, gearbox, differentials and chassis systems. There are seven manual Terrain Response settings: Comfort, Dynamic, Eco, Grass/Gravel/Snow, Mud and Ruts, Sand and Rock Crawl.

## TERRAIN RESPONSE 2

Our unique Terrain Response 2\* system is an option designed to monitor driving conditions and automatically optimise driveability and traction, by adapting the responses of the vehicle's engine, gearbox, centre differential and chassis systems to match the demands of the terrain. You can manually override the system should you wish.



\*Linked feature.



DESIGN

PERFORMANCE

CAPABILITY

TECHNOLOGY

SAFETY

VERSATILITY

PERSONALISATION

## ACTIVE LOCKING REAR DIFFERENTIAL

Locking Rear Differential<sup>1</sup> ensures the greatest level of traction in all weather conditions, both on and off road. Range Rover's permanent All Wheel Drive (AWD) and Electronic Traction Control (ETC), both fitted as standard, distribute torque to both the front and the rear wheels, and brake the wheels independently to improve traction respectively. The addition of the Active Locking Rear Differential delivers the ultimate combination to maximise traction through limiting slip across the rear wheels.

A second multi-plate wet clutch between the rear wheels can lock almost instantly to provide full engine output torque to both wheels. This can be especially useful to deliver effortless capability in low-grip conditions such as patchy ice, wet grass or during wheel articulation off road. It also provides maximum traction when exiting a corner, as when the inside wheel becomes unloaded due to weight transfer, the Active Locking Rear Differential increases the torque to the outside wheel.

## DYNAMIC RESPONSE

Dynamic Response<sup>2</sup> improves vehicle handling through hydraulic roll control, optimising on-road performance and passenger comfort by reducing the amount of body lean during cornering. By controlling the front and rear axles independently, it can deliver increased low-speed agility, along with enhanced high-speed stability and greater steering precision.

## ADAPTIVE DYNAMICS

Adaptive Dynamics makes the miles go by virtually unnoticed. The system monitors vehicle movements up to 500 times a second, reacting to driver or road inputs almost instantaneously, to give greater control and minimise body movement, ensuring a composed, flat ride. The system even senses off-road conditions, and optimises damping accordingly so driver and passengers arrive at their destination refreshed and relaxed.

<sup>1</sup>Not available on D300, P400 engines and P400e SVAutobiography. <sup>2</sup>Only available with V8 engines.



DESIGN

PERFORMANCE

CAPABILITY

TECHNOLOGY

SAFETY

VERSATILITY

PERSONALISATION

## ALL TERRAIN PROGRESS CONTROL

All Terrain Progress Control (ATPC)<sup>1</sup> is a state-of-the-art optional system that enables you to set and maintain a steady speed in challenging conditions such as slippery surfaces, including mud, wet grass, ice, snow and dirt roads. Operating like a cruise control system, it functions at low speed between 1mph and 18mph, enabling you to maintain full concentration on steering and finding a path through obstacles.

## LOW TRACTION LAUNCH

Providing you with optimum torque control when you move off from a standstill, Low Traction Launch can be activated from the Touchscreen and enhances capability in slippery conditions like wet grass, snow and ice.

## HILL DESCENT CONTROL

Land Rover's patented Hill Descent Control (HDC) is a standard feature. It assists the driver with controlled descents of difficult slopes. It does so by maintaining a constant speed and applying braking separately to each wheel.

## WADE SENSING

Unique to Land Rover, this optional system uses ultrasonic sensors in the wing mirrors to visually and audibly alert the driver if the water approaches the vehicle's class-leading wading<sup>2</sup> depth of up to 900mm. It does so by providing real-time pictorial information via the Touchscreen about its depth in relation to the vehicle and its maximum wading capability. Only available with 360° Surround Camera.



<sup>1</sup>Not available with P400e engine. <sup>2</sup>Wading is only available when engine is engaged.



DESIGN

PERFORMANCE

CAPABILITY

TECHNOLOGY

SAFETY

VERSATILITY

PERSONALISATION



# TECHNOLOGY

Delivering a wealth of information and entertainment, every Range Rover is equipped with our InControl infotainment system, Touch Pro Duo. It features intuitive and advanced integrated technologies to ensure everyone can make the most of their journey.

All in-car features should be used by drivers only when safe for them to do so. Drivers must ensure they are in full control of the vehicle at all times.

Interior shown is Autobiography in Navy/Ivory with optional features fitted.





## HEAD-UP DISPLAY

Without distraction or the need for you to take your eyes off the road, Head-up Display is an option that presents key vehicle data such as your speed, gear position and navigation directions on the windscreen. It features crystal-clear, full-colour graphics in high resolution, enabling you to see all driver inputs and information with ease, including phone/call status. The feature can be turned on and off dependent on driver preference.

## INTERACTIVE DRIVER DISPLAY

The 12.3" high-definition Interactive Driver Display can receive and project a vast amount of driving information, entertainment and active safety data including navigation, phone and media. Its high resolution ensures the utmost clarity and its refined processing engine delivers smooth-moving, pin-sharp graphics. Features can be accessed on either the Interactive Driver Display or the Touch Pro Duo Touchscreens.



## TOUCH PRO DUO

The standard 10" dual high-definition Touchscreens allow the user to view required information whilst simultaneously being able to interact with additional features, for increased flexibility and efficiency of use. For instance, you can use the navigation system on the upper screen whilst adjusting multimedia settings on the lower. Direct access to cabin and seat temperature controls are also available via the multi-function Dynamic Dials. For a truly elegant and streamlined appearance, the steering wheel also has hidden-until-lit, touch-sensitive switches as standard. One of these switches is programmable, so that it can be personalised to your preferences to accomplish a host of functions.



DESIGN

PERFORMANCE

CAPABILITY

TECHNOLOGY

SAFETY

VERSATILITY

PERSONALISATION

## REAR SEAT ENTERTAINMENT

The optional Rear Seat Entertainment\* system provides two 10" high-definition, seat-mounted articulating Touchscreens. It includes 'Journey Status', a navigation summary screen which displays a pop-up for the rear occupant detailing the time and distance to destination. The system comes with a pair of WhiteFire® digital wireless headphones and HDMI, Mobile High-definition Link (MHL), CD/DVD player and USB connections. Passengers can also enjoy their favourite TV shows via the Digital TV feature.

\*Linked feature. Model dependent.

WhiteFire® is a registered trademark of Unwired Technology LLC and any use of such marks by Land Rover is under licence.



## CONNECTIVITY

InControl is Land Rover's suite of standard and optional features that connects you to your vehicle and links you seamlessly, and securely, with the outside world. With a selection of apps, even when you're away from your vehicle, some of the InControl features stay with you, making sure the Land Rover experience is more enjoyable than ever.

InControl features, options, third party services and their availability remain market dependent – check with your Land Rover Retailer for local market availability and full terms. Mobile network connectivity cannot be guaranteed in all locations. Information and images displayed in relation to the InControl technology, including screens or sequences, are subject to software updates, version control and other system/visual changes depending on options selected. The Remote App will need to be downloaded from the Apple App Store/ Google Play Store.

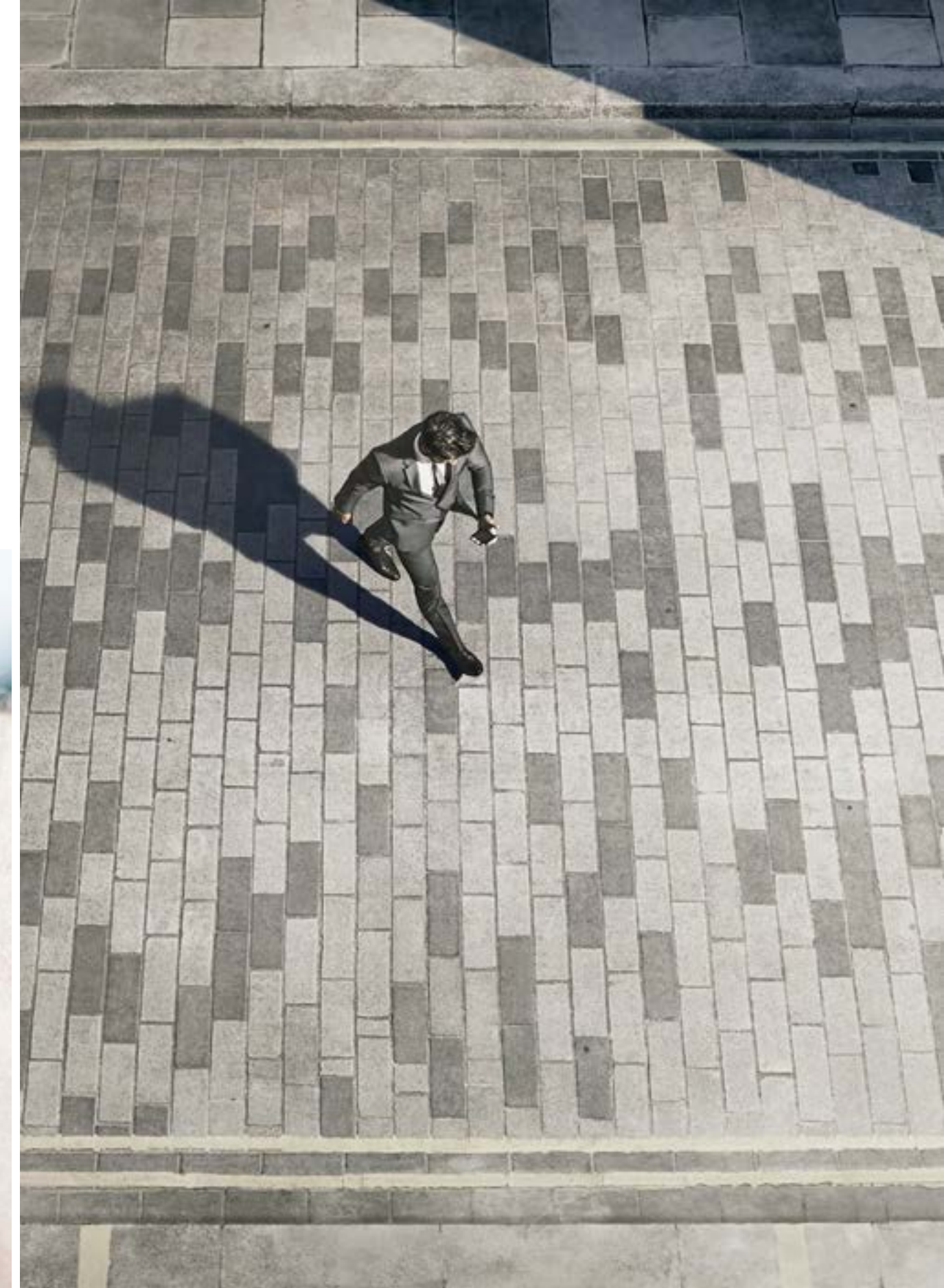



## STANDARD FEATURES

### PROTECT\*

**Land Rover Optimised Assistance** - If you break down you can make a direct call to the Land Rover Assistance team by pressing the button on the overhead console, or from the Assistance screen within the Remote Premium smartphone app.

**SOS Emergency Call** - In a more serious incident, SOS Emergency Call will automatically connect you to the emergency response team who will notify the emergency services to your location.

**Journey Tracking** - This opt-in feature can automatically record your journey history including your route and mileage statistics. This information can be exported by email to use for expense reporting and can be imported to a spreadsheet.

**Vehicle Status Check** - Use your smartphone to remotely check current range levels, and status of door and window position and locks. See the last parked location of the vehicle and find your way back to it with on-foot directions.

### VOICE RECOGNITION SYSTEM

So you can complete tasks without taking your eyes off the road, Range Rover offers intelligent voice recognition. For example, 'tune to 97.9' or 'call home'.

### NAVIGATION PRO

Navigation Pro allows you to save your favourite places, use pinch and zoom gestures for simple map exploration and can display a choice of either 2D or 3D crystal-clear map graphics. Navigation Pro functionality is further enhanced by Connect Pro.

\*Protect and Connect Pro require a SIM with a suitable data contract. Online functionality and Wi-Fi connectivity is dependent on the installation of a micro SIM with a suitable data contract. Protect and Remote Premium contain subscription services that can be extended after the initial term advised by your Land Rover Retailer. InControl features, options and their availability remain market dependent – check with your Land Rover Retailer for local market availability and full terms.



DESIGN

PERFORMANCE

CAPABILITY

TECHNOLOGY

SAFETY

VERSATILITY

PERSONALISATION



## STANDARD FEATURES

### CONNECT PRO

**Connect Pro\*** consists of Remote Premium and Pro Services with 4G Wi-Fi Hotspot, and is designed to enhance your in-car and out-of-car experience, ensuring you and your passengers enjoy the journey whilst remaining connected to the world.

Pro Services include:

- **Real Time Traffic Information**
- **Online Search**
- **Planning Routes and Door-to-Door Routing**
- **Share ETA**
- **Satellite View**
- **Fuel Prices**
- **Commute Mode**
- **Parking Service**
- **Online Routing**
- **Safety Cameras**
- **Online Media**

### REMOTE PREMIUM

**Remote Premium\*** provides information on your vehicle and enables you to interact with it remotely. Compatible with most smartphones, this service includes:

- **Remote Lock/Unlock**
- **Remote Climate**
- **Beep/Flash**

### REMOTE PREMIUM – PHEV ENHANCEMENTS

- **Charging Status Information**
- **Remote Control Actions**

Stay connected while on the move. When specified with 'Connect Pro', your new Range Rover will arrive with a SIM card equipped with an essential data plan of 500MB of data per month for the initial warranty period. You'll be better connected, receiving live traffic updates and more. Additional data can be purchased. Terms, conditions and restrictions apply. Contact your local Land Rover Retailer for more information.

\*Online functionality and Wi-Fi connectivity is dependent on the installation of a micro SIM with suitable data contract. 4G Wi-Fi Hotspot and Pro Services contain subscription services that can be extended after the initial term advised by your Land Rover Retailer.

All in-car features should be used by drivers only when safe for them to do so. Drivers must ensure they are in full control of the vehicle at all times.



## STANDARD FEATURES

### SMARTPHONE PACK

By screen sharing with Range Rover's InControl infotainment system, the Smartphone Pack helps you stay safely connected to your smartphone even while in the car.

Applications include:

- **Android Auto™<sup>1</sup>** - is also designed for increased safety. With a simple and intuitive interface, it is designed to minimise distraction so that you can stay focused on the road. Simply connect your Android smartphone via a USB and control compatible apps on the in-car Touchscreen.
- **Apple CarPlay®<sup>2</sup>** - was designed with safety in mind, enabling the use of apps while allowing the driver to concentrate on the road ahead. Connect your Apple smartphone to your car to use compatible apps such as maps, messages and music through the Touchscreen.

### SECURE TRACKER PRO

It's something we hope you never need to use, but in the event of theft, Secure Tracker<sup>3</sup> helps to locate your vehicle. A theft alert will be sent to the Stolen Vehicle Tracking Centre and to you if someone attempts to move your vehicle illegally. Your vehicle's most recent location will be shared with local authorities.

Secure Tracker Pro<sup>3</sup> takes this even further and integrates authentication technology into the key fob, preventing any non-authorised keys from gaining access to the vehicle.

Secure Tracker Pro is standard for the first 12 months. You can also choose to upgrade the subscription length to the warranty period.



<sup>1</sup>Your car is prepared for Android Auto. The services offered by Android Auto depends on feature availability in your country, please see [android.com](https://www.android.com) for more information. <sup>2</sup>Your car is prepared for Apple CarPlay. The services offered by Apple CarPlay depend on feature availability in your country, please see [apple.co.uk](https://www.apple.co.uk) for more information. <sup>3</sup>Requires mobile network connectivity. Secure Tracker Pro includes service subscription for a limited period of 12 months or longer as advised by your Land Rover Retailer and can be renewed after the initial term.



DESIGN

PERFORMANCE

CAPABILITY

TECHNOLOGY

SAFETY

VERSATILITY

PERSONALISATION



## HOW DOES MUSIC MAKE YOU FEEL?

Music has the power to change your mood, evoke memories and affect your wellbeing. It can give you tingles or make you cry. It's why music and cars go so well together. Sitting behind the wheel, listening to your favourite artist, band or composer. It's your space. Your world.

But what if you could do more than simply listen to the music? What if you could feel it, experience it, immerse yourself in it? What if you could make more of a connection with the music and enjoy a greater sense of acoustic involvement in your Range Rover?

British-based Meridian™ Audio\* are all about the musical experience - the very sense of being there. Their award-winning, precision-engineered audio systems are built on a lifetime of research into psychoacoustics (the science of how the human brain perceives sound) to deliver a performance that is so true to life, you feel every beat, every breath.



\*Meridian is a registered trademark of Meridian Audio Ltd. Trifold and the three fields device is a trademark of Trifold Productions Ltd. Features and their availability may differ by vehicle specification and market.



DESIGN

PERFORMANCE

CAPABILITY

TECHNOLOGY

SAFETY

VERSATILITY

PERSONALISATION

# FEEL THE MUSIC WITH MERIDIAN™

Meridian's approach to in-car audio is all about managing the sound stage; intensifying the levels of depth, clarity and realism of the music, by using a combination of advanced acoustic technology and strategically positioned speakers.

Wherever you sit in the vehicle, you'll get the same concert quality sound. Each strike of the piano, every guitar pick, horn blast, chorus and melody reveals itself with precision and texture, just as the artist intended. It's intimate, dramatic and very atmospheric - whether you're off-road or stuck in rush-hour traffic.

\*Optional feature. Model dependent.

Visuals aim to represent the perceived placement of the musicians based on an occupant seated on the right side of the vehicle.

EXPLORE MERIDIAN



12 SPEAKERS 1 SUBWOOFER 380W AMPLIFIER POWER

## 1. MERIDIAN SOUND SYSTEM

Brings detail and clarity to everyone in the car with strategically arranged speakers and a dual-channel subwoofer to deliver a full, sophisticated sound.



18 SPEAKERS 1 SUBWOOFER 825W AMPLIFIER POWER

## 2. MERIDIAN SURROUND SOUND SYSTEM\*

Enjoy an engaging, authentic concert hall experience as you're enveloped in the fullness and clarity of side, front and rear speakers seamlessly integrated using Trifield™ technology.



28 SPEAKERS 1 SUBWOOFER 1700W AMPLIFIER POWER

## 3. MERIDIAN SIGNATURE SOUND SYSTEM\*

Feel and appreciate music in a new dimension, with additional speakers carefully positioned around the cabin and using Meridian's Trifield 3D technology to create a truly unique 'live' sound experience.



DESIGN

PERFORMANCE

CAPABILITY

TECHNOLOGY

SAFETY

VERSATILITY

PERSONALISATION

## MAKING DRIVING EASIER

From negotiating city traffic or the motorway, to providing additional safety for you and your passengers, there's a wealth of innovative technologies available - either as standard, optional or as part of an optional pack. Whichever you choose, you'll find every single feature has been designed and engineered to heighten your enjoyment of the vehicle.

### STANDARD DRIVE FEATURES

**Cruise Control and Speed Limiter** allows the driver to maintain the current speed of the vehicle without the need for continued use of the accelerator pedal.

**Emergency Braking** can help to prevent collisions with other vehicles or pedestrians. If a potential frontal collision is detected, a warning is displayed, giving you time to take action.

**Lane Departure Warning** can help make long journeys much safer. The system senses when your vehicle is unintentionally drifting out of your lane, and notifies you with a visual alert and a gentle vibration of the steering wheel.

### OPTIONAL DRIVE FEATURES

**Adaptive Cruise Control\*** will keep your vehicle a safe distance from the one in front, should it slow or stop when you're cruising on the motorway or travelling in slow-moving traffic. Should the vehicle in front stop completely, your vehicle will come to a smooth halt. In stop-start traffic, Adaptive Cruise Control will automatically resume following the car in front.

**High-speed Emergency Braking\*** detects when a potential frontal collision with another vehicle may occur and displays a forward alert to warn the driver to brake. If the driver doesn't react, the vehicle will deploy the brakes in order to reduce the severity of the possible impact.



Lane Departure Warning



Adaptive Cruise Control

\*Linked feature.

All in-car features should be used by drivers only when safe for them to do so. Drivers must ensure they are in full control of the vehicle at all times.

## DRIVE PACKS

### OPTIONAL DRIVE PACK

The optional Drive Pack\* offers a range of features that help keep you safe and informed. The Drive Pack includes:

**Driver Condition Monitor** detects if you're starting to feel drowsy and gives you an early warning when you need to take a break.

**Blind Spot Monitor** alerts you to vehicles in, or quickly approaching, your blind spot. When a vehicle is detected, a small warning light will illuminate in the corresponding wing mirror. If you indicate in the direction of the obstacle, the warning light will flash to highlight potential danger.

**Traffic Sign Recognition** keeps you informed and aware on the road, by displaying speed limits and 'no overtaking' signs in the instrument cluster, where they can easily be seen.

**Adaptive Speed Limiter** uses data from the Traffic Sign Recognition system to automatically select speed limit. If the system detects the vehicle is above the speed limit, such as when entering a lower limit, the accelerator will be disabled allowing the vehicle to coast down to the limit. The driver can also apply the brakes to achieve this more quickly.

### OPTIONAL DRIVE PRO PACK

For an even more relaxed drive, the optional Drive Pro Pack\* contains a wide range of driver assistance features including the Driver Condition Monitor and Traffic Sign Recognition with Adaptive Speed Limiter in the Drive Pack, plus:

**Lane Keep Assist** detects when your vehicle is unintentionally drifting out of your lane, and applies a corrective torque to the steering wheel, encouraging you to guide your vehicle back.

**Blind Spot Assist** can help prevent collisions. If your vehicle detects another car in your blind spot when you begin to change lanes, a small warning light illuminates in the corresponding wing mirror and a corrective steering torque encourages you to guide your vehicle away from the approaching vehicle.

**Adaptive Cruise Control** - See previous page for description.

**High-speed Emergency Braking** - See previous page for description.



Traffic Sign Recognition with Adaptive Speed Limiter



Blind Spot Assist

\*Linked feature.



DESIGN

PERFORMANCE

CAPABILITY

TECHNOLOGY

SAFETY

VERSATILITY

PERSONALISATION

## PARK FEATURES

### ENJOY STRESS-FREE PARKING

Range Rover offers the most advanced technologies to deliver intuitive and easy parking solutions. Whether reversing, parallel parking or getting into or out of tight spaces, these features make life easier. Available as standard, optional or as part of an optional pack.

#### STANDARD PARK FEATURES

**Front and Rear Parking Aid** helps make manoeuvring even easier. When you select Reverse, or choose to activate them manually, sensors located in the front and rear bumpers are triggered. As you park, the Touchscreen display and audio feedback indicate how close you are to obstacles.

**Rear Camera** provides improved visibility when reversing. Static lines representing the vehicle's outer perimeter and predicted path are superimposed on the rearward image, to make parking in tight spots as easy as possible. This valuable parking aid also helps when hitching a trailer.

#### OPTIONAL PARK FEATURES

**360° Surround Camera** uses four digital cameras discreetly placed around the vehicle, providing a 360° overhead view on the Touchscreen. With the capacity to display several different views at the same time, this helps with various manoeuvres from parking by a kerb, to getting in and out of tight spaces and junctions.



Front and Rear Parking Aid



360° Surround Camera



DESIGN

PERFORMANCE

CAPABILITY

TECHNOLOGY

SAFETY

VERSATILITY

PERSONALISATION

## OPTIONAL PARK PACK

The optional Park Pack assists you with manoeuvring in tight spaces and in urban environments. It features:

**360° Parking Aid** gives you complete confidence when manoeuvring in tight spaces. Sensors located around the vehicle are automatically triggered when Reverse is selected, or can be manually activated, with a graphic appearing on the Touchscreen showing an overhead view of the vehicle. As you park, the Touchscreen display and audio feedback indicate how close you are to obstacles.

**Rear Traffic Monitor** is particularly useful when reversing out of a parking bay. The system warns you of vehicles, pedestrians or other hazards approaching from either side of your vehicle. It will alert you with both audio and visual warnings, so you know what's behind you even when the view is obstructed.

**Clear Exit Monitor** alerts rear passengers to any approaching cars, cyclists or other hazards before they leave the vehicle. As the rear seat passenger pulls the door handle to leave your vehicle, a warning light will flash on the rear door if an incoming obstacle is detected.

## OPTIONAL PARK PRO PACK

The optional Park Pro Pack enables you to park and manoeuvre safely and securely in and out of tight spaces and into traffic that is obscured by buildings or other vehicles. It includes the 360° Parking Aid, Rear Traffic Monitor and Clear Exit Monitor in the Park Pack, plus:

**Park Assist** makes parallel and perpendicular parking easier than ever, by steering your vehicle into a suitable space. You just have to select the appropriate gear and control the vehicle's speed with the brake and accelerator pedals. Graphics and notifications guide you through the manoeuvres. Park Assist will also steer you out of a space, taking all of the stress out of parking.

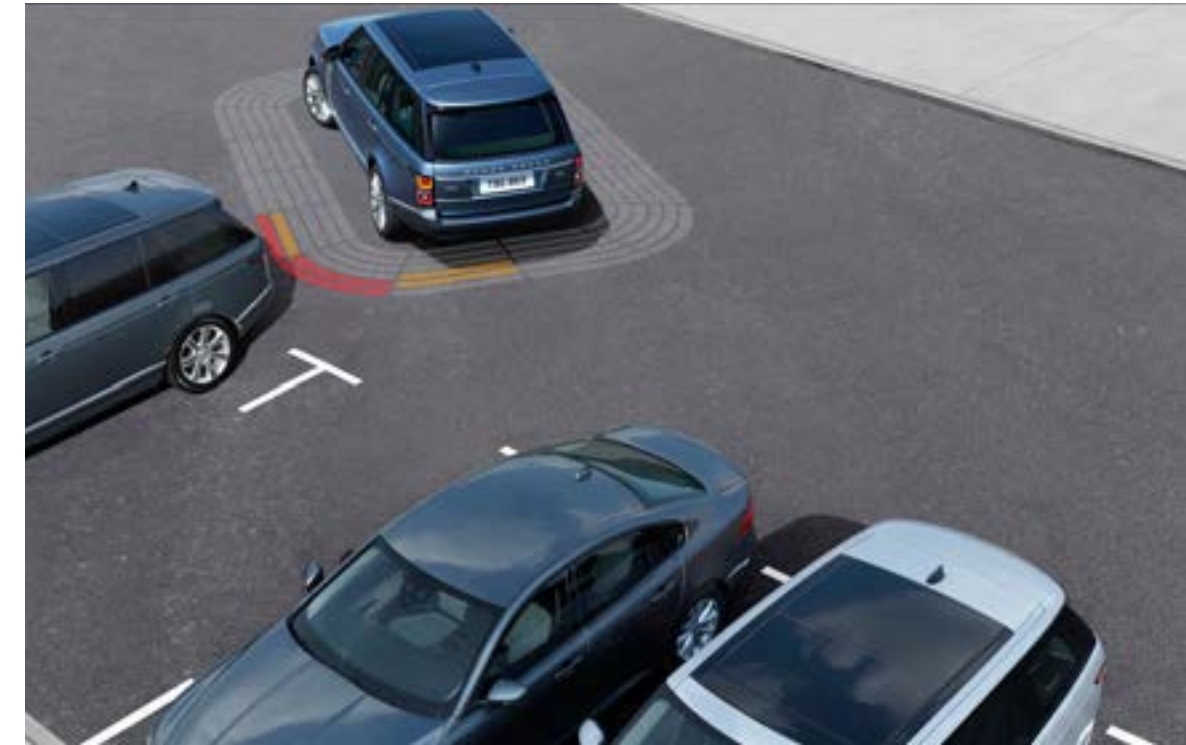

360° Parking Aid



Park Assist

## DRIVER ASSIST PACK

The optional Driver Assist Pack\* offers a wide range of driver aids including the features found in the Drive Pro Pack (see page 36), the Park Pro Pack (see page 38) and the 360° Surround Camera. It also includes Adaptive Cruise Control with Steering Assist. This latest technology makes motorway driving and heavy traffic situations even easier and more comfortable. It achieves this by gently assisting acceleration and braking to maintain a set distance from vehicles ahead. Moderate steering interventions ensure that the physical effort of maintaining a central vehicle position is reduced.

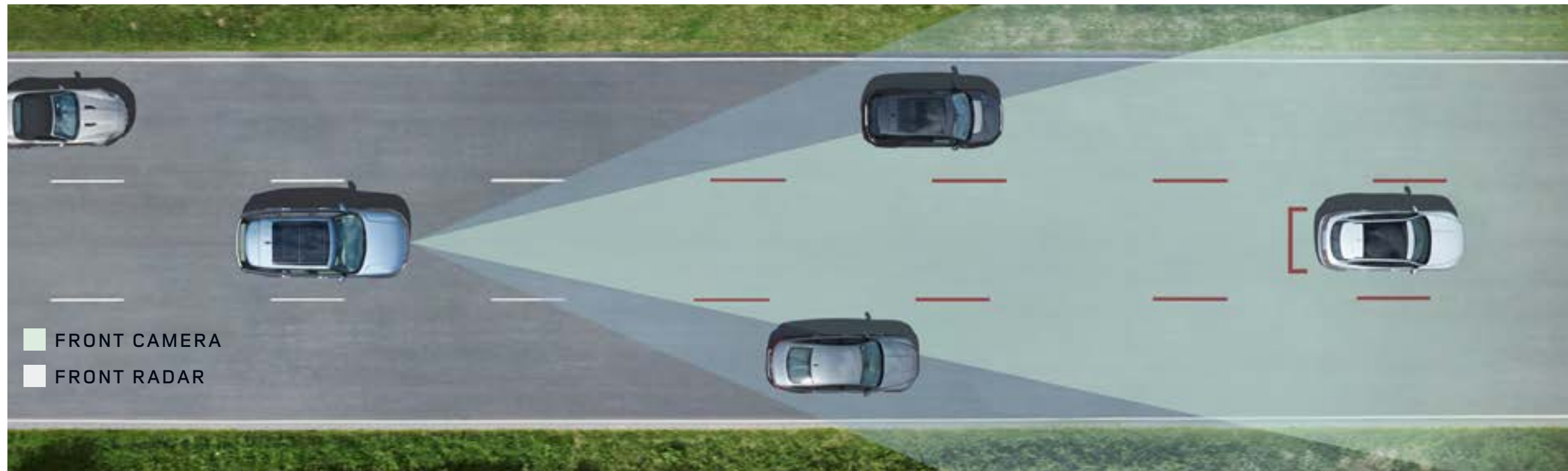

\*Linked feature.

Vehicle shown is Autobiography in Byron Blue with Navy/Ivory interior with optional features fitted.

## SUSTAINABLE BY DESIGN

Land Rover are committed to producing vehicles that use more sustainable materials, produce less waste and use fewer natural resources as part of our approach to sustainable business. Range Rover's development process has included a full life-cycle assessment and has been designed to be 85 percent recyclable/reusable and 95 percent recoverable at the end of the vehicle's life.

Our innovative design enables the use of a unique alloy in the vehicle body, made from up to 50 percent recycled aluminium derived from our closed-loop manufacturing process, retaining quality and performance but delivering lower life-cycle CO<sub>2</sub> emissions. Closed-loop manufacturing means taking the scrap from the body pressings process, segregating it and re-melting it back into quality sheet aluminium at our supplier, to be used again to press out body panels, thereby reducing the need to use primary aluminium.



DESIGN

PERFORMANCE

CAPABILITY

TECHNOLOGY

SAFETY

VERSATILITY

PERSONALISATION



## ECO MODE

Eco Mode ensures the vehicle runs more efficiently and economically by using software to implement a range of actions from softening the pedal on throttle and gear changes to retuning the heating, ventilation and air conditioning when in Auto mode and switching off heated door mirrors.

## LOW CO<sub>2</sub> TECHNOLOGIES

Range Rover powertrains incorporate a variety of low CO<sub>2</sub> technologies. Our intelligent Stop/Start system is designed to improve fuel efficiency and reduce emissions. Mild Hybrid Electric Vehicle (MHEV) - considered the next generation of Stop/Start technology - takes this even further. The combined effect of both systems gives a 12 percent reduction in CO<sub>2</sub> emissions for P400 petrol engines. Our latest Plug-in Hybrid Electric Vehicle (PHEV) ensures both optimum performance and efficiency.

## ENGINE MANUFACTURING CENTRE

Jaguar Land Rover's Engine Manufacturing Centre, where our Ingenium engines are assembled, has been built to the highest environmental standard (BREEAM Excellent) and features one of the largest rooftop solar panel installations in the UK. Compromising no fewer than 22,600 individual panels with 6.2MW generating capacity, the panels have the capability to provide up to 30 percent of the site's energy needs.



# SAFE AND SECURE

With its sophisticated design cues and use of materials, Range Rover provides a high degree of protection. Its all-aluminium monocoque body makes it one of the strongest vehicles of its kind. The inclusion of high-strength aluminium in the body structure ensures minimum intrusion into the safety cell in the event of a collision, while the elevated Command Driving Position provides enhanced visibility in all conditions. You can see more of the road and be easily seen by other road users, providing an enhanced feeling of safety and confidence.

Vehicle shown is Autobiography in Byron Blue with optional features fitted.



It has also been engineered to include a wealth of standard features, not only to protect you and your passengers, but to actively help prevent accidents occurring:

**Dynamic Stability Control (DSC)** monitors Range Rover's dynamic behaviour, intervening to maximise vehicle stability. DSC reduces engine torque and applies braking to the appropriate wheels, to correct the vehicle's direction of travel by counteracting understeer or oversteer.

**Anti-lock Braking System (ABS)** allows the vehicle to maintain traction with the road surface whilst braking and prevents wheels from locking - thereby retaining the vehicle's ability to steer. The system helps to shorten the braking distance.

**Electronic Brake-force Distribution (EBD)** automatically varies the braking force to each axle in order to minimise stopping distance, while still maintaining stability and the vehicle's ability to steer.

**Electronic Traction Control (ETC)** optimises traction and stability by controlling wheel spin. The ETC system reduces torque to the spinning wheel, then applies braking to the wheel, if required.

**Cornering Brake Control (CBC)** automatically varies the braking force to each wheel when the vehicle's brakes are applied around a corner and the limit of grip is reached. The system will prevent the vehicle's wheels from locking up and skidding in this event through varying the braking force applied to each wheel.

**Roll Stability Control (RSC)** is integrated with DSC to reduce the possibility of rollover, while providing agility and ability to steer around obstacles. It monitors the vehicle motion and cornering forces to detect any potential risk of rollover. When risk is detected, braking is applied to the outside front wheel to reduce forces that contribute to rollover.

**Emergency Brake Assist** understands when you apply the brakes quickly but without the necessary force to maximise stopping performance. It therefore boosts the brake pressure through the ABS pump to ensure you stop in time.

**Hazard Lights Under Braking** - To help reduce the risk of a collision, the Emergency Stop Signal system automatically activates the hazard warning lights during emergency braking.



To improve safety further for all the family, two ISOFIX points for baby/child seat restraints are fitted on each side of the rear seats, and additional protection is offered by seat belt pretensioners which, in the event of a front impact, reduce forward movement. To further protect you, there is a comprehensive system of airbags including driver and passenger airbags, side curtain and thorax.

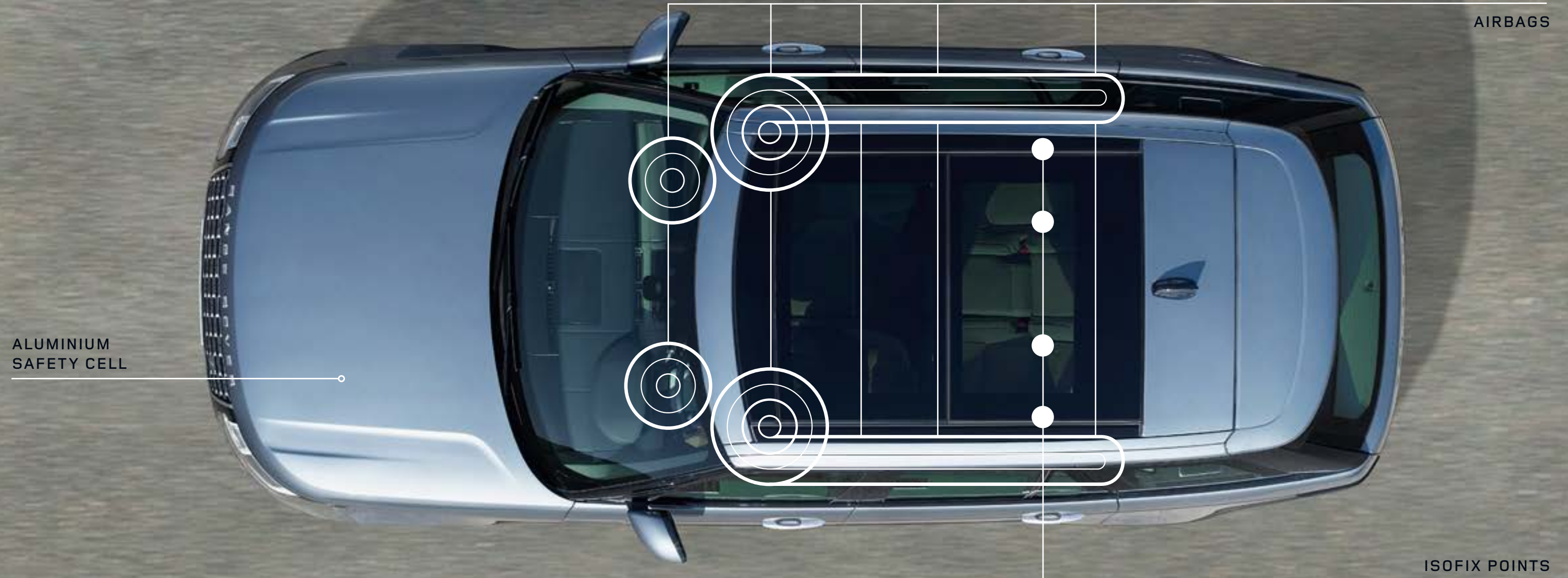

DESIGN

PERFORMANCE

CAPABILITY

TECHNOLOGY

SAFETY

VERSATILITY

PERSONALISATION

## LIGHTING TECHNOLOGY

Range Rover features all-round exterior LED lighting with standard features, including front signature Daytime Running Lights, automatic headlights and power wash. LED lights are designed to last the lifetime of the vehicle and are more energy efficient. Also, the quality of light produced is closer to daylight conditions, so driving at night becomes less tiring.

A range of beam pattern assistance features provide maximum light while minimising the impact on other road users.



DESIGN

PERFORMANCE

CAPABILITY

TECHNOLOGY

SAFETY

VERSATILITY

PERSONALISATION

**Matrix LED headlights** and **Pixel LED headlights\*** both feature an Adaptive Front-lighting System (AFS) and also enable Advanced Driving Beam (ADB). The AFS optimises the lighting beam to suit a range of driving conditions - including town, country, motorway and bad weather - while the ADB allows you to use both the high and low beam concurrently. By splitting the main beam into vertical strips, the Matrix LED headlights can cast up to four vertical shadows in front of vehicles ahead, to help to prevent dazzling without having to dip the main beam and lose the illumination.

**Pixel LED headlights\***, with nearly three times as many LEDs than the Matrix headlights, offer our most advanced headlight technology and build on the ADB capability to ensure maximum light. By splitting the main beam pattern vertically and horizontally, they enable up to four higher definition shadows, to help to avoid dazzling multiple vehicles ahead. This headlight option incorporates bending lights, which operate at higher speeds to direct the main beam pattern according to the direction of steering.

**Pixel-laser LED headlights\*** build on the Pixel LED headlight option with the addition of laser technology. The long-range laser high beam delivers five times higher luminance than standard LED lights, and is particularly useful for long, straight road driving. They become operational above 50mph and when no other external lights detected, to produce clear sight for up to 550m.

**Additional signpost dimming** - standard with Matrix headlights - will turn off the LEDs that would otherwise shine on road signs and create glare. While Tourist Mode technology adjusts the AFS beam patterns depending on which side of the road you are driving on (e.g. driving in another country).

\*Optional feature.



# ELEGANT ARRIVAL

Automatic Access Height allows you to get in and out of the vehicle with greater ease and elegance as, when activated, this feature lowers the vehicle by as much as 50mm. Prior to leaving the vehicle, Optional Clear Exit Monitor\* provides an alert to rear seat passengers to prevent them opening the door onto approaching obstacles. The vehicle is also available with optional soft door close to provide power latching on the front and rear doors.

\*Linked feature.



AUTOMATIC ACCESS HEIGHT 50MM



DESIGN

PERFORMANCE

CAPABILITY

TECHNOLOGY

SAFETY

VERSATILITY

PERSONALISATION

## INTERIOR CLIMATE

To prevent the cabin from overheating in the sun and minimise demands on the air conditioning, the auto sunblind<sup>1</sup> closes automatically when passengers have disembarked and the doors are locked. When the vehicle is re-opened, the sunblind returns to the position prior to it auto-closing.

Optional Four-zone Climate Control helps make life more comfortable for everyone, utilising a fully independent rear heating and air conditioning unit to ensure all occupants enjoy optimum comfort.

## CABIN AIR PURIFICATION SYSTEM WITH PM2.5 FILTER<sup>2</sup>

By activating the PURIFY button in your vehicle, our specially designed filter will attract and capture fine particulates such as PM2.5, and airborne allergens such as dust and pollen from the outside air. The optional system cleanses the air in the cabin environment, reducing the vehicle occupants' exposure to the pollutants.

The nanoe™ ionisation technology enhances the well-being of both driver and passengers alike. It does so by ionising particles in the air, making them attract to and neutralise the air contaminants.



<sup>1</sup>Linked feature. <sup>2</sup>Optional feature.



DESIGN

PERFORMANCE

CAPABILITY

TECHNOLOGY

SAFETY

VERSATILITY

PERSONALISATION



## INTELLIGENT SEAT CARGO MODE/CONVENIENCE FOLD

**Intelligent Seat Cargo Mode** - enabling the power fold of the rear seats, whilst moving the front seats forward and preventing obstruction - is fitted with all 60:40 bench seats with power recline and load through (ideal for long items such as skis). **Convenience Fold**, available with the optional rear Executive Class seats only, allows you to configure the rear seats via the upper Touchscreen or an app on your smartphone, which can be truly useful when you're returning with a clutch of shopping bags or an awkward load.



DESIGN

PERFORMANCE

CAPABILITY

TECHNOLOGY

SAFETY

VERSATILITY

PERSONALISATION

# BENCH SEATING



## 5 SEATS

DRY	WET
707/707	900/900
LITRES	LITRES
(SWB/LWB)	(SWB/LWB)



## 4 SEATS

DRY	WET
1,102/1,220	1,416/1,528
LITRES	LITRES
(SWB/LWB)	(SWB/LWB)



## 3 SEATS

DRY	WET
1,299/1,477	1,674/1,842
LITRES	LITRES
(SWB/LWB)	(SWB/LWB)



## 2 SEATS

DRY	WET
1,694/1,990	2,190/2,470
LITRES	LITRES
(SWB/LWB)	(SWB/LWB)

On P400e variants the loadspace capacity is reduced by up to 98 litres and the loadspace floor is raised by 46mm.  
Interior shown is Autobiography in Navy/Ivory with optional features fitted.



DESIGN

PERFORMANCE

CAPABILITY

TECHNOLOGY

SAFETY

VERSATILITY

PERSONALISATION

# REAR EXECUTIVE CLASS SEATING



## 5 SEATS

DRY	WET
532/532	694/694
LITRES	LITRES
(SWB/LWB)	(SWB/LWB)



## 4 SEATS

DRY	WET
748/810	974/1,030
LITRES	LITRES
(SWB/LWB)	(SWB/LWB)



## 3 SEATS

DRY	WET
1,179/1,365	1,534/1,701
LITRES	LITRES
(SWB/LWB)	(SWB/LWB)



## 2 SEATS

DRY	WET
1,611/1,920	2,094/2,373
LITRES	LITRES
(SWB/LWB)	(SWB/LWB)

Dry: Volume as measured with VDA-compliant solid blocks (200mm x 50mm x 100mm).  
 Wet: Volume as measured by simulating the loadspace filled with liquid.

## POWER AND STOWAGE

With an optional domestic power socket, up to five 12V sockets and up to seven USB ports located throughout the cabin, multiple electronic devices can be charged on the go. And to ensure your cabin is clutter-free, there is increased stowage space including a recess specifically for smartphones in the front centre console compartment.

In addition to the optional front centre cooler compartment, a front centre refrigerator compartment can be specified as an alternative, to provide the luxury of cooling drinks on demand. It can accommodate up to four 500ml bottles and maintain them at a temperature of 5°C, with the ability to perform a rapid cool to quickly chill your drink.



DESIGN

PERFORMANCE

CAPABILITY

TECHNOLOGY

SAFETY

VERSATILITY

PERSONALISATION

## ACTIVITY KEY

With the optional Activity Key you can enjoy your favourite activities and keep your vehicle key securely in the vehicle. For extra convenience, you can strap the Activity Key to your wrist. The wristband is robust and fully waterproof, allowing you to take part in a range of activities from horse riding to swimming. Simply touch your Activity Key on the tailgate (behind the letter R in the Range Rover script) to lock or unlock the car and deactivate or reactivate the conventional key fob.

## TAILGATE

The split tailgate is distinctly Range Rover. Its electrically operated upper and lower tailgates help provide a platform for social and sporting events, coupled with greater protection from the elements. Powered gesture tailgate allows you to open and close the tailgate from the kerb without needing to touch either the vehicle or the key fob. And as the system is compatible with optional towing solutions, you can still tackle demanding situations with the least amount of fuss. Access to the loadspace is enhanced with Rear Height Adjust which lowers the rear suspension by up to 50mm when the tailgate is opened. This creates a more natural ramp angle for ease of loading.



## TOWING

With a towing capacity of up to 3,500kg\* and by incorporating tailored technologies, Range Rover can handle the most demanding of tasks.

## TOW HITCH ASSIST

Tow Hitch Assist makes coupling a trailer to the vehicle much easier by helping you visualise the hitching process; it displays the predicted path of the vehicle tow ball towards the trailer tow bar on the Touchscreen.

## REAR HEIGHT ADJUST

Rear Height Adjust allows the use of switches in the loadspace or on the key fob to lower the rear suspension height by up to 50mm - useful when loading or unloading cumbersome items, or when hitching, unhitching or loading a trailer.

\*Engine dependent.

Vehicle shown is Autobiography in Byron Blue with optional features fitted.



DESIGN

PERFORMANCE

CAPABILITY

TECHNOLOGY

SAFETY

VERSATILITY

PERSONALISATION

## ELECTRICALLY DEPLOYABLE TOW BAR<sup>1</sup>

This optional system is deployed using a convenient button in the loadspace compartment, or via the Touchscreen.

## TRAILER STABILITY ASSIST

Trailer Stability Assist (TSA) gives you greater stability when towing. Should TSA detect a dangerous trailer sway situation is developing, it can help you regain control by gradually reducing Range Rover's speed through lowering engine power and applying the brakes individually on each side of the vehicle, to control the sway.

## TOW ASSIST

Tow Assist helps with reversing by predicting the trailer's direction. The system displays the predicted path of both the vehicle and the trailer as coloured trajectory lines on the Touchscreen. For precise guidelines you can even choose your trailer's width. Standard with 360° Surround Camera.

## ADVANCED TOW ASSIST

Advanced Tow Assist<sup>12</sup> allows you to control the direction of your trailer when reversing by using the rotary Terrain Response 2 controller. The optional system will control the vehicle's steering to achieve the desired trailer trajectory.

<sup>1</sup>Engine dependent. <sup>2</sup>Linked feature.



# SVAUTOBIOGRAPHY DYNAMIC

Vehicle shown is SVAutobiography Dynamic in Firenze Red with optional features fitted.





## EXTERIOR

Designed and engineered by Special Vehicle Operations (SVO) – Land Rover’s centre of excellence for bespoke commissions, luxury editions and performance models – the SVAutobiography Dynamic offers the pinnacle in performance and luxury.

Designed for luxury performance, the flowing lines and contemporary design of SVAutobiography Dynamic will turn heads all over the world. With a tuned chassis, steering, exhaust and suspension, the SVAutobiography Dynamic sits 8mm lower than a standard Range Rover – its aggressive stance hinting at the power and performance contained within.

Unique Graphite Atlas accents, distinctive Red Land Rover branded brake calipers and exclusive wheels add to the performance appeal of the vehicle. The SVAutobiography Dynamic provides a new level of agility and performance for the driver to enjoy.



## INTERIOR

Encapsulating luxurious comfort and style, the interior of SVAutobiography Dynamic epitomises the very best in sublime craftsmanship. Alluring to the touch, only the very finest Diamond Quilted leathers feature within the cabin. A knurled finish to interior features, including the Stop/Start button and foot pedals, adds to the sense of refinement. The rotary shifter and Steel Weave Carbon Fibre finishers reflect SVAutobiography Dynamic's distinctive personality.

Actual seats have new cushions and interlayers with softer, looser leather to optimise these features. Please refer to your Land Rover Retailer for more information.

Interior shown is SVAutobiography Dynamic in Ebony/Vintage Tan with Ebony/Vintage Tan seats and Steel Weave Carbon Fibre veneer with optional features fitted.



DESIGN

PERFORMANCE

CAPABILITY

TECHNOLOGY

SAFETY

VERSATILITY

PERSONALISATION

# SVAUTOBIOGRAPHY LONG WHEELBASE

Vehicle shown is SVAutobiography Long Wheelbase with Duo Tone paint in Eiger Grey and Santorini Black with optional features fitted.



## EXTERIOR

Craftsmanship never goes out of style, and over 50 years of expertise in designing Range Rover is manifested in each SVAutobiography Long Wheelbase. Every tailored aspect whispers elegance and attention to detail. Approaching the front, each vehicle is crafted with luxury design cues such as the unique front grille<sup>1</sup> and 'Range Rover' front and rear script with a dark knurled-effect finish, edged in Bright Chrome.

The SVAutobiography Long Wheelbase retains a poised stance, even with the 200mm extra length. Body-coloured side vent graphics are punctuated by Bright Chrome inserts, with Bright Chrome door handle surrounds and tailgate finisher. Unique 21" and 22" wheel choices complete the luxury design.

To reflect your personal taste, the option of exterior Duo Tone paint allows customers to specify the vehicle in one of eight exterior colours<sup>2</sup> below the waistline, with a Santorini Black, Aruba or Eiger Grey finish above the waistline to produce a prestigious appearance.



<sup>1</sup>Not available on P400e PHEV engine. <sup>2</sup>Also available with SVO Ultra Metallic and Special Effect paint colours.

## INTERIOR

Having operated the power close rear doors from fully open at the touch of a button, the interior of SVAutobiography Long Wheelbase is revealed as the epitome of refined, sophisticated and indulgent living. Attention to the minutiae is in everything you see and touch. From the rear centre console's power deployable tables to the exclusive Diamond Quilted leather seats and rear seat refrigerated compartment, the vehicle exudes confidence and a calm, collected air.

A knurled finish to interior features such as the Stop/Start button, Zenith clock, rotary shifter and armrest adjusters, all add to the refined look. The leather-wrapped sides of the parcel shelf and loadspace, and Executive Class Comfort Plus seats come as standard. This ensures every journey is a truly relaxing experience. The power deployable loadspace floor<sup>1</sup> is available in a veneer<sup>2</sup> or carpet finish to enhance this area of the vehicle, and can also be specified with an optional tailgate event seating system. This provides two comfortable luxury leather seats which mount in the tailgate when the vehicle is stationary, for participating in outdoor events.

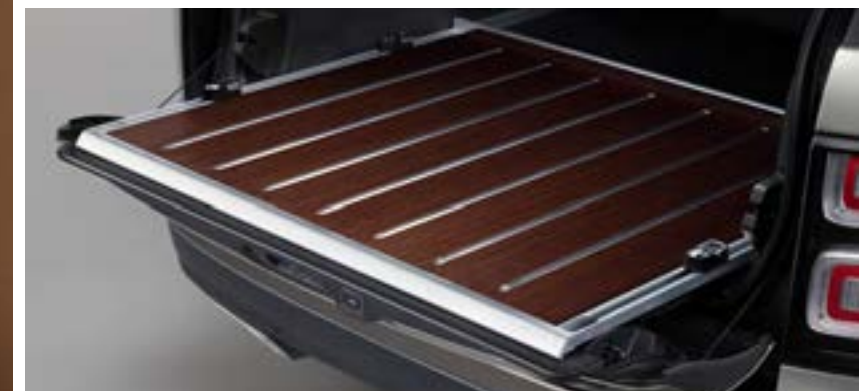

<sup>1</sup>Not available with P400e PHEV engine. <sup>2</sup>Loadspace floor veneer finish will match the interior veneer selected except with Copper Weave Carbon Fibre and Grand Black veneer, where the loadspace floor will have a Black Burr Ash veneer finish.

Actual seats have new cushions and interlayers with softer, looser leather to optimise these features. Please refer to your Land Rover Retailer for more information.

Interior shown is SVAutobiography Long Wheelbase in Vintage Tan/Vintage Tan with Satin Santos Palisander veneer and optional features fitted.



DESIGN

PERFORMANCE

CAPABILITY

TECHNOLOGY

SAFETY

VERSATILITY

PERSONALISATION

# LAND ROVER ACCESSORIES

 BUILD YOUR OWN

Land Rover Accessories can be purchased through your Land Rover Retailer and added at any stage of the vehicle's life - not just when it's new. Land Rover accessories are designed, tested and manufactured to the same exacting standards as the original equipment fitted to your vehicle.

For more information and to see the full list of accessories please visit [accessories.landrover.com](https://accessories.landrover.com)

You can also include accessories when you configure your Range Rover at [landrover.co.uk](https://landrover.co.uk)

Vehicle shown is Autobiography in Byron Blue with optional features fitted.



DESIGN

PERFORMANCE

CAPABILITY

TECHNOLOGY

SAFETY

VERSATILITY

PERSONALISATION

## EXTERIOR STYLING

**SVO Design Pack<sup>1</sup>** – SVO Design Packs provide a purposeful, dynamic and stunning styling enhancement that allow customers to add their own stamp of individuality by tailoring their Range Rover. Exterior features include a unique front bumper with integrated tailpipes, side vents, grille and side sill claddings.

**Noble Chrome Mirror Covers** – Noble Chrome plated mirror covers designed to enhance Range Rover's exterior styling cues. This neat styling upgrade complements various Dark Atlas, Light Atlas and Bright finish exterior trims.

**Deployable Side Steps<sup>2</sup>** – These smart, practical steps make it easier to get in and out of the vehicle. Neatly stowed under the sills, the side steps automatically deploy as soon as the door is opened, or when activated by the key fob. They stow automatically when the door is closed. The side steps are sensitive to obstructions and will not deploy in off-road or low-range settings. Automatic Mode can be overridden to allow access to the roof when the doors are closed.

**Fixed Side Steps<sup>2</sup>** – Complete with a rubber tread mat and Brushed Stainless Steel trim, the fixed side steps provide easy access/exit to the vehicle's cabin and aid access to the roof. With embossed Range Rover branding, exterior Bright work and Bright anodised aluminium edge trim finish, they complement the vehicle's exterior styling cues.

<sup>1</sup>Offered for SWB only. Only applicable for vehicles fitted with fog lamps only. Not available for Plug-in Hybrid Electric Vehicles. Front and Rear Mudflaps, not available with SVO Design Pack. <sup>2</sup>Fitting of side steps may affect the off-road capability of the vehicle. Not compatible with SVO Design Pack.



## INTERIOR STYLING

**Illuminated Treadplates** - Illuminated Treadplates with Range Rover lettering and halo surround. Rear treadplates feature illuminated halo only.

**Personalised Illuminated Treadplates** - Personalised Illuminated Treadplates allow you to choose a personalised message using an approved set of fonts/typefaces which will be highlighted in white illumination when the front doors are open.

**Gearshift Paddles**<sup>1</sup> - Complete the look and feel of your steering wheel with premium aluminium paddles. Gearshift Paddles are machine polished, anodised and hand brushed to provide exceptional wear resistance with a premium finish.

## INTERIOR PROTECTION

**Rubber Mats** - Rubber footwell mats for front and second row occupants help provide protection from general dirt. Featuring Bright accent Range Rover ingot and durable metal corner pieces.

**Loadspace Rubber Mat** - Range Rover branded waterproof rubber mat, helps protect the rear loadspace carpet from general dirt.

**Loadspace Reversible Carpet Mat and Liner**<sup>1,2</sup> - All-in-one premium loadspace carpet mat and double layer reversible rubber liner helps protect the rear loadspace area from general dirt. The liner can be folded out to cover the back of the second row seats when folded down. Also includes fold out bumper protector.

**Full Height Luggage Partition** - Designed to protect vehicle occupants against the displacement of luggage. Following initial retailer installation the luggage partition can be removed with appropriate fitting tool.

<sup>1</sup>Linked feature. <sup>2</sup>Engine dependent.





## CARRYING

**Tow Bar Mounted Bike Carrier<sup>1</sup>** - The Tow Bar Mounted Bike Carrier features a one-hand, quick attach/release tow bar coupling mechanism and can be tilted away from the vehicle, by use of a foot pedal, to allow easy access into the rear tailgate. Maximum load capacity 40kg for two bikes and 51kg for three bikes.

**Sports Roof Box<sup>2</sup>** - Sleek, aerodynamic design Sports Roof Box with a Gloss Black finish which can be mounted on either side of the vehicle for kerbside opening. Internal retention system for skis or other long loads. Lockable for security.

**Roof Mounted Bike Carrier<sup>2</sup>** - Roof-mounted, lockable bike carrier designed for holding a single bike, up to 20kg.

**Aqua Sports Carrier<sup>2</sup>** - Carries a sailboard, canoe or kayak. Includes lockable multi-purpose holder to carry oars or paddles. Tilts to facilitate easy loading/unloading. Features lockable straps and rubber supports to maintain optimum weight distribution whilst protecting the kayak and vehicle from scratches/scuffs. Maximum load capacity 45kg.

**Ski/Snowboard Carrier<sup>2</sup>** - Carries four pairs of skis or two snowboards. Incorporates slider rails for easy loading, and is also lockable for security. Maximum payload 36kg.

<sup>1</sup>Linked feature. Requires 50mm tow hitch and 13 pin tow electrics for fitment. Heat shield also required for fitment. <sup>2</sup>Roof rails and cross bars are required for all Land Rover roof-mounted accessories. Maximum payload equals the load capacity of the roof-mounted accessory. Objects placed above the roof-mounted satellite antenna may reduce the quality of the signal received by the vehicle and could have a detrimental effect on the navigation and satellite radio systems, if fitted. Some roof carrying accessories may restrict the opening of the vehicle's sliding sunroof when fitted. Care should be taken when opening the roof to avoid collision with any items fitted above the vehicle.



## FUNCTION AND TECHNOLOGY

**Wireless Phone Charging Cup Holder** - The Wireless Phone Charging Cup Holder has been designed to charge utilising the cup holder space in the centre console. The holder will accommodate varying phone sizes securely in place. The charger displays an LED light to indicate when charging, and turns off when complete. Fits phones up to 72mm wide.

**Centre Armrest Cooler/Warmer Box<sup>1</sup>** - Food and drinks cooler and warmer that acts as a rear centre armrest. With a leather-covered top, it is held in place by the centre seat belt and powered from the rear auxiliary socket. Ideal for long journeys with the family.

**Click and Go System<sup>2</sup>** - The Click and Go Range is a multi purpose seat-back system for second row passengers. The versatile Click and Go Base fixes between the headrest mountings and further attachments can be added to hold tablets, bags, and shirts or jackets. Each attachment is sold separately. The base can be easily removed when not in use.

**Tailgate Event Seating in Ebony leather<sup>3</sup>** - The Tailgate Event Seating is handcrafted from beautiful Ebony Windsor leather with a highly durable aluminium frame. Stowed in the loadspace, these seats can be quickly and easily fitted to provide comfortable seating for two adults on the lower tailgate, when the vehicle is stationary.

<sup>1</sup>Not applicable for vehicles equipped with Executive second row seating. <sup>2</sup>Linked feature. Not compatible with vehicles equipped with Rear Seat Entertainment. <sup>3</sup>Mounts to tailgate when opened. Not available with PHEV.



## PET PRODUCTS

**Pet Loadspace Protection Pack<sup>1</sup>** - Designed to provide water resistant protection and easy cleaning of the loadspace from wet and muddy paws. Combines the Quilted Loadspace Liner<sup>2</sup>, Full Height Luggage Partition<sup>1</sup> and Spill Resistant Pet Bowl.

**Pet Transportation Pack** - Convenient option to provide a comfortable environment for transporting pets, which can be fitted or removed quickly as and when required. Combines the Foldable Pet Carrier, Spill Resistant Pet Bowl and Loadspace Rubber Mat.

**Pet Care and Access Pack<sup>1</sup>** - Taking the effort out of transporting pets, this option ensures everything required is to hand to transport pets in comfort. Combines the Full Height Luggage Partition<sup>1</sup>, Quilted Loadspace Liner<sup>2</sup>, Pet Access Ramp and Portable Rinse System.

**Quilted Loadspace Liner<sup>2</sup>** - A tailored liner which covers and protects the loadspace floor, second row seat backs and loadspace side walls up to window height. Manufactured from a soft quilted fabric, with an integral rubber mat and detachable bumper protector, it is ideal for owners who regularly carry pets in the loadspace of their vehicle.

**Foldable Pet Carrier** - The Foldable Pet Carrier provides a safe, comfortable environment for the transportation of pets. Manufactured from a durable 600D nylon, the Foldable Pet Carrier has a lightweight metal frame and includes a quilted fabric cushion, net windows and a spring loaded locking mechanism which snaps into place when required. Windsor leather carry handles and corner pieces provide a premium finish, with a side pocket providing a convenient stowage option for other pet accessories or small items.

<sup>1</sup>Not available with PHEV or MHEV.

<sup>2</sup>Not available with PHEV.



DESIGN

PERFORMANCE

CAPABILITY

TECHNOLOGY

SAFETY

VERSATILITY

PERSONALISATION

# CHOOSE YOUR MODEL

EXPLORE THIS MODEL

## RANGE ROVER VOGUE

Features Atlas grille mesh detailing and front bumper accent, while the interior presents refinements such as perforated Windsor leather seats.



DESIGN

PERFORMANCE

CAPABILITY

TECHNOLOGY

SAFETY

VERSATILITY

PERSONALISATION

## RANGE ROVER VOGUE SE

In addition to Vogue, features Atlas door handle surrounds, 21" Style 7001, 7 split-spoke alloy wheels and perforated Semi-Aniline leather seats.

[EXPLORE THIS MODEL](#)



DESIGN

PERFORMANCE

CAPABILITY

TECHNOLOGY

SAFETY

VERSATILITY

**PERSONALISATION**

## RANGE ROVER WESTMINSTER

Elegance. Refinement. A distinctive silhouette. Range Rover Westminster Edition embodies those qualities that define the marque. A sliding panoramic roof, Atlas exterior accents, Grand Black veneer and suedecloth headlining are just some of its many noteworthy features.

[EXPLORE THIS MODEL](#)



DESIGN

PERFORMANCE

CAPABILITY

TECHNOLOGY

SAFETY

VERSATILITY

PERSONALISATION

## RANGE ROVER WESTMINSTER BLACK

With the addition of Black exterior features such as bonnet and tailgate lettering, grille detail and front bumper accent, together with 22" Style 9012, 9 split-spoke, Gloss Black wheels\*, this vehicle has a dynamic and confident stance.

[EXPLORE THIS MODEL](#)



\*21" Style 9001, 9 spoke, Gloss Black wheels on P400e.



DESIGN

PERFORMANCE

CAPABILITY

TECHNOLOGY

SAFETY

VERSATILITY

PERSONALISATION

## RANGE ROVER AUTOBIOGRAPHY

An exceptionally luxurious SUV, featuring Atlas front bumper vent finishers, side vent and side accent graphics, with an interior featuring rear Executive Class seating.

[EXPLORE THIS MODEL](#)



DESIGN

PERFORMANCE

CAPABILITY

TECHNOLOGY

SAFETY

VERSATILITY

PERSONALISATION





EXPLORE THIS MODEL

## RANGE ROVER SVAUTOBIOGRAPHY DYNAMIC

Range Rover SVAutobiography Dynamic is designed for luxury performance. Exclusively available in Standard Wheelbase with the 5.0 litre V8 Supercharged 565HP engine.



DESIGN

PERFORMANCE

CAPABILITY

TECHNOLOGY

SAFETY

VERSATILITY

PERSONALISATION



EXPLORE THIS MODEL

## RANGE ROVER SVAUTOBIOGRAPHY DYNAMIC BLACK

Unique features, design details and impressive levels of performance take this SVAutobiography Dynamic vehicle to formidable new heights. Santorini Black exterior paint, 22" Style 5087, 5 split-spoke wheels with Gloss Black finish, Black brake calipers and a Grand Black veneer are all standard. This is a vehicle that never fails to delight. Or excite.



DESIGN

PERFORMANCE

CAPABILITY

TECHNOLOGY

SAFETY

VERSATILITY

PERSONALISATION



[EXPLORE THIS MODEL](#)

## RANGE ROVER SVAUTOBIOGRAPHY LONG WHEELBASE

The pinnacle of refinement, SVAutobiography Long Wheelbase offers a luxury knurled finish to interior features and Executive Class Comfort-Plus rear seats.



DESIGN

PERFORMANCE

CAPABILITY

TECHNOLOGY

SAFETY

VERSATILITY

**PERSONALISATION**



## THE RANGE ROVER COLLECTION

Our exclusive collection of accessories is inspired by our vehicles and made with a quintessentially British sense of style.

**Range Rover Leather Tote Bag** - Style, simplicity, sophistication. It all comes to the fore with this cross-grained leather tote bag in Deep Garnet. Featuring a chevron print lining with an easy-to-reach internal key pocket, its design is understated yet unmistakable.

**Range Rover Round Keyring** - Crafted from Milled Steel, this distinctive keyring is inspired by the Range Rover rotary dial. With a Black nickel finish and debossed wordmark to the outer ring edge.

**Range Rover Umbrella** - Your cover for all conditions. This wind-tested Range Rover Umbrella features a Black leather handle with debossed Range Rover wordmark, spring-loaded automatic opening and polycotton canopy.

**Range Rover Cufflinks** - A refined set of whale-back cufflinks inspired by the Range Rover rotary dial and crafted from Milled Steel. With a Black nickel finish and debossed wordmark.

**Range Rover Leather Wallet** - An elegant cross-grained leather wallet in Deep Garnet with chevron print to the inner lining. Features Range Rover rotary dial detail with debossed wordmark to the inside.

**Range Rover Sunglasses** - Lightweight aviator-style sunglasses in Silver. Machined from a single sheet of Japanese beta-titanium, with NXT® polarized lenses for ultimate UV protection and colour clarity. Other styles available.



[EXPLORE THE COLLECTION](#)



DESIGN

PERFORMANCE

CAPABILITY

TECHNOLOGY

SAFETY

VERSATILITY

PERSONALISATION

# THE WORLD OF LAND ROVER



Your Land Rover has been designed and engineered to help you make more of your world. It can take you to places others simply can't reach, in a style that cannot be matched. With a vehicle from Special Vehicle Operations, that sense of individuality can be taken to even greater heights. As a celebration of the Land Rover lifestyle, we've put together a range of experiences, publications and the Land Rover Lifestyle Collection. There's a world to explore. Get out there and enjoy it.



> BOOK AN EXPERIENCE



> SPECIAL VEHICLE OPERATIONS



> LAND ROVER COLLECTION



> LAND ROVER ADVENTURE TRAVEL



DESIGN

PERFORMANCE

CAPABILITY

TECHNOLOGY

SAFETY

VERSATILITY

PERSONALISATION



### BUILD YOUR OWN

Use the configurator to design your perfect Range Rover.



### FIND A RETAILER

Search for a Land Rover Retailer near you.



### COMPARE OUR VEHICLES

Select up to three Land Rover vehicles and compare them side by side.



### BOOK A TEST DRIVE

Arrange a test drive through your local Land Rover Retailer.

## YOUR PEACE OF MIND

> CUSTOMER SERVICE

> LAND ROVER ROADSIDE ASSISTANCE

> LAND ROVER FINANCIAL SERVICES

> LAND ROVER FLEET & BUSINESS



DESIGN

PERFORMANCE

CAPABILITY

TECHNOLOGY

SAFETY

VERSATILITY

PERSONALISATION

IMPORTANT NOTICE: Jaguar Land Rover Limited is constantly seeking ways to improve the specification, design and production of its vehicles, parts and accessories, and alterations take place continually. Whilst every effort is made to produce up-to-date literature, this brochure should not be regarded as an infallible guide to current specifications or availability, nor does it constitute an offer for the sale of any particular vehicle, part or accessory. Distributors and Retailers are not agents of Jaguar Land Rover Limited by any express or implied undertaking or representation.

COLOURS: Image colours reproduced here are provided for illustrative purposes only. Colours are reproduced on-screen and may therefore vary compared to the actual finish. The company reserves the right to alter or withdraw any colour finish without notice. Some of these colours may not be obtainable in your country. Please check availability of colours and current specifications with your Land Rover Retailer. Distributors and Retailers are not agents of Jaguar Land Rover Limited and have absolutely no authority to bind Jaguar Land Rover Limited to any express or implied undertaking or representation.

Information and images displayed in relation to the InControl technology, including Touchscreen, App screens, or sequences are subject to regular software updates, version control and other system/visual changes depending on options selected.

Optional features and their availability may differ by vehicle specification (model and powertrain), or require the installation of other features in order to be fitted. Please contact your local Retailer for more details, or configure your vehicle online. All in-car features should be used by drivers only when safe for them to do so. Drivers must ensure they are in full control of the vehicle at all times. Certain features require an appropriate SIM with a suitable data contract, which will require a further subscription after the initial term advised by your Retailer.

Castrol EDGE Professional exclusively recommended by Land Rover.

Android™ is a trademark of Google LLC.

Apple® is a registered trademark of Apple Inc., registered in the US and other countries.

Meridian™ is a registered trademark of Meridian Audio Ltd. Trifield™ and the three fields device is a trademark of Trifield Productions Ltd.

**Jaguar Land Rover Limited**

Registered Office: Abbey Road, Whitley,  
Coventry CV3 4LF United Kingdom.

Registered in England: Number 1672070

landrover.co.uk

© Copyright Jaguar Land Rover Limited 2020.

1L4052010000BGBEN01P

21.5MY



DESIGN

PERFORMANCE

CAPABILITY

TECHNOLOGY

SAFETY

VERSATILITY

PERSONALISATION

# RANGE ROVER

TECHNICAL SPECIFICATION 2020



ABOVE & BEYOND





## ENGINES – SWB

Configure your Range Rover at [landrover.co.uk](http://landrover.co.uk)

### POWERTRAIN

Mild Hybrid Electric Vehicle (MHEV)

Transmission

Driveline

Maximum power (HP/kW/rpm)

Maximum torque (Nm/rpm)

Capacity (cc)

No. of cylinders/Valves per cylinder

Cylinder layout

Bore/stroke (mm)

Compression ratio (:1)

### FUEL ECONOMY - WLTP\*

WLTP Consumption	Low	mpg (l/100km)
	Medium	mpg (l/100km)
	High	mpg (l/100km)
	Extra High	mpg (l/100km)
	Combined	mpg (l/100km)

WLTP CO <sub>2</sub> Emissions	Combined	g/km
-----------------------------------	----------	------

### DIESEL MHEV

#### D300

■

Automatic

All Wheel Drive (AWD)

300 (221)/4,000

650/1,500 - 2,500

2,997

6/4

In-line

83/92.32

15.5

#### D350

■

Automatic

All Wheel Drive (AWD)

350 (258)/4,000

700/1,500 - 3,000

2,997

6/4

In-line

83/92.32

15.5

21.1 - 20.1 (13.4 - 14.1)

35.7 - 33.0 (7.9 - 8.6)

40.6 - 36.8 (7.0 - 7.7)

33.2 - 30.6 (8.5 - 9.2)

33.0 - 30.5 (8.6 - 9.3)

225 - 243

19.1 - 18.5 (14.8 - 15.3)

33.3 - 31.8 (8.5 - 8.9)

37.7 - 34.7 (7.5 - 8.2)

31.8 - 29.4 (8.9 - 9.6)

30.8 - 28.9 (9.2 - 9.8)

241 - 256

■ Standard.

\*WLTP is the new official EU test used to calculate standardised fuel consumption and CO<sub>2</sub> figures for passenger cars. It measures fuel, energy consumption, range and emissions. This is designed to provide figures closer to real-world driving behaviour. It tests vehicles with optional equipment and with a more demanding test procedure and driving profile. Figures are shown as a range under WLTP testing measures. The lowest figures refer to the most economical/lightest set of options. The highest figures refer to the least economical/heaviest set of options. WLTP legislation dictates that where there is <5g CO<sub>2</sub> variance between the lowest and highest figures, only the highest is declared.

## TECHNICAL SPECIFICATION – SWB

	DIESEL MHEV	
	D300	D350
<b>FUEL ECONOMY - continued</b>		
Fuel tank capacity - useable litres	86	86
Selective Catalytic Reduction Filter/ Gasoline Particulate Filter (SCR/F/GPF)	■	■
<b>PERFORMANCE</b>		
Acceleration (secs) 0-60mph (0-100 km/h)	7.1 (7.4)	6.8 (7.1)
Maximum speed mph (km/h)	130 (209)	140 (225)
<b>BRAKES</b>		
Front type	Ventilated disc	Ventilated disc
Front diameter (mm)	363	380
Rear type	Ventilated disc	Ventilated disc
Rear diameter (mm)	350	365
Park Brake	Electric Park Brake (EPB) integrated into brake caliper	
<b>WEIGHTS (kg)*</b>		
Unladen weight (EU)**	2,350	2,350
Unladen weight (DIN)†	2,275	2,275
Gross Vehicle Weight (GVW)	3,150	3,150
<b>TOWING (kg)</b>		
Unbraked trailer	750	750
Maximum towing	3,500	3,500
Maximum coupling point (nose weight)	150	150
Maximum vehicle and trailer combination	6,650	6,650
<b>ROOF CARRYING (kg)</b>		
Maximum roof load (including cross bars)	100	100

■ Standard.

\*Weights reflect vehicles to standard specifications. Optional extras increase weight.

\*\*Includes a 75kg driver, full fluids and 90% fuel.

†Includes full fluids and 90% fuel.

## ENGINES – SWB

<b>POWERTRAIN</b>			<b>PETROL PHEV</b>	<b>PETROL MHEV</b>
			<b>P400e</b>	<b>P400</b>
Mild Hybrid Electric Vehicle (MHEV)			-	■
Transmission			Automatic	Automatic
Driveline			All Wheel Drive (AWD)	All Wheel Drive (AWD)
Maximum power (HP/kW/rpm)			404 (297)/5,500*	400 (294)/5,500 - 6,500
Maximum torque (Nm/rpm)			640/1,500 - 4,000	550/2,000 - 5,000
Capacity (cc)			1,997	2,996
No, of cylinders/Valves per cylinder			4/4	6/4
Cylinder layout			In-line	In-line
Bore/stroke (mm)			83/92.29	83/92.29
Compression ratio (:1)			9.5	10.5
<b>FUEL ECONOMY - WLTP**</b>				
EV Range (EAER)	Combined	miles (km)	25 - 24 (40 - 39)	-
	Low	mpg (l/100km)	-	18.2 - 17.4 (15.5 - 16.2)
WLTP Consumption	Medium	mpg (l/100km)	-	27.4 - 25.8 (10.3 - 11.0)
	High	mpg (l/100km)	-	32.2 - 30.0 (8.8 - 9.4)
	Extra High	mpg (l/100km)	-	27.0 - 25.2 (10.5 - 11.2)
	Combined	mpg (l/100km)	84.8 - 73.0 (3.3 - 3.9)	26.7 - 25.0 (10.6 - 11.3)
WLTP CO <sub>2</sub> Emissions	Combined	g/km	75 - 87	240 - 256

■ Standard - Not Available.

\*When combined with electric motor.  
 \*\*WLTP is the new official EU test used to calculate standardised fuel consumption and CO<sub>2</sub> figures for passenger cars. It measures fuel, energy consumption, range and emissions. This is designed to provide figures closer to real-world driving behaviour. It tests vehicles with optional equipment and with a more demanding test procedure and driving profile. Figures are shown as a range under WLTP testing measures. The lowest figures refer to the most economical/lightest set of options. The highest figures refer to the least economical/heaviest set of options. WLTP legislation dictates that where there is <5g CO<sub>2</sub> variance between the lowest and highest figures, only the highest is declared.

## TECHNICAL SPECIFICATION – SWB

	PETROL PHEV	PETROL MHEV
	P400e	P400
<b>FUEL ECONOMY - continued</b>		
Fuel tank capacity - useable litres	91	104
Selective Catalytic Reduction Filter/ Gasoline Particulate Filter (SCR/F/GPF)	■	■
<b>PERFORMANCE</b>		
Acceleration (secs) 0-60mph (0-100 km/h)	6.0 (6.4)	5.9 (6.3)
Maximum speed mph (km/h)	137 (220)	140 (225)
<b>ELECTRIC MOTOR DATA</b>		
Maximum Power HP (kW)	143 (105)	-
Maximum Torque (Nm)	275	-
<b>BRAKES</b>		
Front type	Ventilated disc	Ventilated disc
Front diameter (mm)	380	380
Rear type	Ventilated disc	Ventilated disc
Rear diameter (mm)	365	365
Park Brake	Electric Park Brake (EPB) integrated into brake caliper	
<b>WEIGHTS (kg)*</b>		
Unladen weight (EU)**	2,577	2,342
Unladen weight (DIN)†	2,502	2,267
Gross Vehicle Weight (GVW)	3,210	3,140
<b>TOWING (kg)</b>		
Unbraked trailer	750	750
Maximum towing	2,500	3,500
Maximum coupling point (nose weight)	100	150
Maximum vehicle and trailer combination	5,710	6,640
<b>ROOF CARRYING (kg)</b>		
Maximum roof load (including cross bars)	100	100

■ Standard - Not Available.

\*Weights reflect vehicles to standard specifications. Optional extras increase weight.

\*\*Includes a 75kg driver, full fluids and 90% fuel.

†Includes full fluids and 90% fuel.

## ENGINES – SWB

<b>POWERTRAIN</b>			<b>PETROL</b>	
			<b>P525</b>	<b>P565</b>
Transmission			Automatic	Automatic
Driveline			All Wheel Drive (AWD)	All Wheel Drive (AWD)
Maximum power (HP/kW/rpm)			525 (386)/6,000 - 6,500	565 (416)/6,000 - 6,500
Maximum torque (Nm/rpm)			625/2,500 - 5,500	700/3,500 - 5,000
Capacity (cc)			5,000	5,000
No, of cylinders/Valves per cylinder			8/4	8/4
Cylinder layout			Longitudinal V	Longitudinal V
Bore/stroke (mm)			92.5/93	92.5/93
Compression ratio (:1)			9.5	9.5
<b>FUEL ECONOMY - WLTP*</b>				
WLTP Consumption	Low	mpg (l/100km)	13.5 - 12.6 (21.0 - 22.5)	12.3 (22.9)
	Medium	mpg (l/100km)	20.4 - 19.2 (13.8 - 14.7)	18.9 (15.0)
	High	mpg (l/100km)	23.8 - 22.6 (11.9 - 12.5)	22.2 (12.7)
	Extra High	mpg (l/100km)	22.1 - 21.0 (12.8 - 13.4)	20.4 (13.8)
	Combined	mpg (l/100km)	20.5 - 19.3 (13.8 - 14.6)	18.9 (14.9)
WLTP CO <sub>2</sub> Emissions	Combined	g/km	311 - 330	342

\*WLTP is the new official EU test used to calculate standardised fuel consumption and CO<sub>2</sub> figures for passenger cars. It measures fuel, energy consumption, range and emissions. This is designed to provide figures closer to real-world driving behaviour. It tests vehicles with optional equipment and with a more demanding test procedure and driving profile. Figures are shown as a range under WLTP testing measures. The lowest figures refer to the most economical/lightest set of options. The highest figures refer to the least economical/heaviest set of options. WLTP legislation dictates that where there is <5g CO<sub>2</sub> variance between the lowest and highest figures, only the highest is declared.

## TECHNICAL SPECIFICATION – SWB

	PETROL	
	P525	P565
<b>FUEL ECONOMY - continued</b>		
Fuel tank capacity - useable litres	104	104
Selective Catalytic Reduction Filter/ Gasoline Particulate Filter (SCR/F/GPF)	■	■
<b>PERFORMANCE</b>		
Acceleration (secs) 0-60mph (0-100 km/h)	5.1 (5.4)	5.1 (5.4)
Maximum speed mph (km/h)	140/155* (225/250*)	140/155* (225/250*)
<b>BRAKES</b>		
Front type	Ventilated disc	Ventilated disc
Front diameter (mm)	380	380
Rear type	Ventilated disc	Ventilated disc
Rear diameter (mm)	365	365
Park Brake	Electric Park Brake (EPB) integrated into brake caliper	
<b>WEIGHTS (kg)**</b>		
Unladen weight (EU) <sup>†</sup>	2,450	2,591
Unladen weight (DIN) <sup>††</sup>	2,375	2,516
Gross Vehicle Weight (GVW)	3,160	3,160
<b>TOWING (kg)</b>		
Unbraked trailer	750	750
Maximum towing	3,500	3,500
Maximum coupling point (nose weight)	150	150
Maximum vehicle and trailer combination	6,660	6,660
<b>ROOF CARRYING (kg)</b>		
Maximum roof load (including cross bars)	100	100

\*With 22" wheel.

\*\*Weights reflect vehicles to standard specifications. Optional extras increase weight.

<sup>†</sup>Includes a 75kg driver, full fluids and 90% fuel.

<sup>††</sup>Includes full fluids and 90% fuel.

## ENGINES – LWB

### POWERTRAIN

Mild Hybrid Electric Vehicle (MHEV)

Transmission

Driveline

Maximum power (HP/kW/rpm)

Maximum torque (Nm/rpm)

Capacity (cc)

No. of cylinders/Valves per cylinder

Cylinder layout

Bore/stroke (mm)

Compression ratio (:1)

### FUEL ECONOMY - WLTP\*

WLTP Consumption	Low	mpg (l/100km)
	Medium	mpg (l/100km)
	High	mpg (l/100km)
	Extra High	mpg (l/100km)
	Combined	mpg (l/100km)

WLTP CO <sub>2</sub> Emissions	Combined	g/km
-----------------------------------	----------	------

### DIESEL MHEV

#### D350

■

Automatic

All Wheel Drive (AWD)

350 (258)/4,000

700/1,500 - 3,000

2,997

6/4

In-line

83/92.32

15.5

19.0 - 18.5 (14.9 - 15.3)

33.0 - 31.6 (8.6 - 8.9)

37.1 - 34.2 (7.6 - 8.3)

31.3 - 29.0 (9.0 - 9.7)

30.4 - 28.7 (9.3 - 9.9)

244 - 259

■ Standard.

\*WLTP is the new official EU test used to calculate standardised fuel consumption and CO<sub>2</sub> figures for passenger cars. It measures fuel, energy consumption, range and emissions. This is designed to provide figures closer to real-world driving behaviour. It tests vehicles with optional equipment and with a more demanding test procedure and driving profile. Figures are shown as a range under WLTP testing measures. The lowest figures refer to the most economical/lightest set of options. The highest figures refer to the least economical/heaviest set of options. WLTP legislation dictates that where there is <5g CO<sub>2</sub> variance between the lowest and highest figures, only the highest is declared.

## TECHNICAL SPECIFICATION – LWB

### FUEL ECONOMY - continued

Fuel tank capacity - useable litres

Selective Catalytic Reduction Filter/  
Gasoline Particulate Filter (SCR/GPF)

### PERFORMANCE

Acceleration (secs) 0-60mph (0-100 km/h)

Maximum speed mph (km/h)

### BRAKES

Front type

Front diameter (mm)

Rear type

Rear diameter (mm)

Park Brake

### WEIGHTS (kg)\*

Unladen weight (EU)\*\*

Unladen weight (DIN)†

Gross Vehicle Weight (GVW)

### TOWING (kg)

Unbraked trailer

Maximum towing

Maximum coupling point (nose weight)

Maximum vehicle and trailer combination

### ROOF CARRYING (kg)

Maximum roof load (including cross bars)

### DIESEL MHEV

#### D350

86

■

6.9 (7.2)

140 (225)

Ventilated disc

380

Ventilated disc

365

Electric Park Brake (EPB) integrated into brake caliper

2,518

2,443

3,210

750

3,500

150

6,710

100

■ Standard.

\*Weights reflect vehicles to standard specifications. Optional extras increase weight.

\*\*Includes a 75kg driver, full fluids and 90% fuel.

†Includes full fluids and 90% fuel.



## ENGINES – LWB

<b>POWERTRAIN</b>			<b>PETROL PHEV</b>	<b>PETROL MHEV</b>
			<b>P400e</b>	<b>P400</b>
Mild Hybrid Electric Vehicle (MHEV)			-	■
Transmission			Automatic	Automatic
Driveline			All Wheel Drive (AWD)	All Wheel Drive (AWD)
Maximum power (HP/kW/rpm)			404 (297)/5,500*	400 (294)/5,500 - 6,500
Maximum torque (Nm/rpm)			640/1,500 - 4,000	550/2,000 - 5,000
Capacity (cc)			1,997	2,996
No, of cylinders/Valves per cylinder			4/4	6/4
Cylinder layout			In-line	In-line
Bore/stroke (mm)			83/92.29	83/92.29
Compression ratio (:1)			9.5	10.5
<b>FUEL ECONOMY - WLTP**</b>				
EV Range (EAER)	Combined	miles (km)	25 - 24 (40 - 39)	-
	Low	mpg (l/100km)	-	18.0 - 17.4 (15.7 - 16.3)
WLTP Consumption	Medium	mpg (l/100km)	-	26.8 - 25.6 (10.5 - 11.0)
	High	mpg (l/100km)	-	31.5 - 29.7 (9.0 - 9.5)
	Extra High	mpg (l/100km)	-	26.4 - 24.8 (10.7 - 11.4)
	Combined	mpg (l/100km)	81.4 - 69.9 (3.5 - 4.0)	26.1 - 24.8 (10.8 - 11.4)
WLTP CO <sub>2</sub> Emissions	Combined	g/km	78 - 91	245 - 258

■ Standard - Not Available.

\*When combined with electric motor.  
 \*\*WLTP is the new official EU test used to calculate standardised fuel consumption and CO<sub>2</sub> figures for passenger cars. It measures fuel, energy consumption, range and emissions. This is designed to provide figures closer to real-world driving behaviour. It tests vehicles with optional equipment and with a more demanding test procedure and driving profile. Figures are shown as a range under WLTP testing measures. The lowest figures refer to the most economical/lightest set of options. The highest figures refer to the least economical/heaviest set of options. WLTP legislation dictates that where there is <5g CO<sub>2</sub> variance between the lowest and highest figures, only the highest is declared.

## TECHNICAL SPECIFICATION – LWB

	PETROL PHEV	PETROL MHEV
	P400e	P400
<b>FUEL ECONOMY - continued</b>		
Fuel tank capacity - useable litres	91	104
Selective Catalytic Reduction Filter/ Gasoline Particulate Filter (SCR/F/GPF)	■	■
<b>PERFORMANCE</b>		
Acceleration (secs) 0-60mph (0-100 km/h)	6.2 (6.5)	6.1 (6.5)
Maximum speed mph (km/h)	137 (220)	140 (225)
<b>ELECTRIC MOTOR DATA</b>		
Maximum Power HP (kW)	143 (105)	-
Maximum Torque (Nm)	275	-
<b>BRAKES</b>		
Front type	Ventilated disc	Ventilated disc
Front diameter (mm)	380	380
Rear type	Ventilated disc	Ventilated disc
Rear diameter (mm)	365	365
Park Brake	Electric Park Brake (EPB) integrated into brake caliper	
<b>WEIGHTS (kg)*</b>		
Unladen weight (EU)**	2,671	2,450
Unladen weight (DIN)†	2,596	2,375
Gross Vehicle Weight (GVW)	3,250	3,170
<b>TOWING (kg)</b>		
Unbraked trailer	750	750
Maximum towing	2,500	3,500
Maximum coupling point (nose weight)	100	150
Maximum vehicle and trailer combination	5,750	6,670
<b>ROOF CARRYING (kg)</b>		
Maximum roof load (including cross bars)	100	100

■ Standard - Not Available.

\*Weights reflect vehicles to standard specifications. Optional extras increase weight.

\*\*Includes a 75kg driver, full fluids and 90% fuel.

†Includes full fluids and 90% fuel.

## ENGINES – LWB

<b>POWERTRAIN</b>			<b>PETROL</b>	
			<b>P525</b>	<b>P565</b>
Transmission			Automatic	Automatic
Driveline			All Wheel Drive (AWD)	All Wheel Drive (AWD)
Maximum power (HP/kW/rpm)			525 (386)/6,000 - 6,500	565 (416)/6,000 - 6,500
Maximum torque (Nm/rpm)			625/2,500 - 5,500	700/3,500 - 5,000
Capacity (cc)			5,000	5,000
No, of cylinders/Valves per cylinder			8/4	8/4
Cylinder layout			Longitudinal V	Longitudinal V
Bore/stroke (mm)			92.5/93	92.5/93
Compression ratio (:1)			9.5	9.5
<b>FUEL ECONOMY - WLTP*</b>				
WLTP Consumption	Low	mpg (l/100km)	13.3 - 12.4 (21.3 - 22.7)	12.6 (22.4)
	Medium	mpg (l/100km)	20.1 - 19.1 (14.0 - 14.8)	18.5 (15.3)
	High	mpg (l/100km)	23.6 - 22.4 (12.0 - 12.6)	21.6 (13.1)
	Extra High	mpg (l/100km)	21.9 - 20.8 (12.9 - 13.6)	19.9 (14.2)
	Combined	mpg (l/100km)	20.2 - 19.2 (14.0 - 14.7)	18.6 (15.2)
WLTP CO <sub>2</sub> Emissions	Combined	g/km	315- 333	342

\*WLTP is the new official EU test used to calculate standardised fuel consumption and CO<sub>2</sub> figures for passenger cars. It measures fuel, energy consumption, range and emissions. This is designed to provide figures closer to real-world driving behaviour. It tests vehicles with optional equipment and with a more demanding test procedure and driving profile. Figures are shown as a range under WLTP testing measures. The lowest figures refer to the most economical/lightest set of options. The highest figures refer to the least economical/heaviest set of options. WLTP legislation dictates that where there is <5g CO<sub>2</sub> variance between the lowest and highest figures, only the highest is declared.

## TECHNICAL SPECIFICATION – LWB

	PETROL	
	P525	P565
<b>FUEL ECONOMY - continued</b>		
Fuel tank capacity - useable litres	104	104
Selective Catalytic Reduction Filter/ Gasoline Particulate Filter (SCR/F/GPF)	■	■
<b>PERFORMANCE</b>		
Acceleration (secs) 0-60mph (0-100 km/h)	5.2 (5.5)	5.2 (5.2)
Maximum speed mph (km/h)	140/155* (225/250*)	140/155* (225/250*)
<b>BRAKES</b>		
Front type	Ventilated disc	Ventilated disc
Front diameter (mm)	380	380
Rear type	Ventilated disc	Ventilated disc
Rear diameter (mm)	365	365
Park Brake	Electric Park Brake (EPB) integrated into brake caliper	
<b>WEIGHTS (kg)**</b>		
Unladen weight (EU) <sup>†</sup>	2,518	2,673
Unladen weight (DIN) <sup>††</sup>	2,443	2,598
Gross Vehicle Weight (GVW)	3,200	3,200
<b>TOWING (kg)</b>		
Unbraked trailer	750	750
Maximum towing	3,500	3,500
Maximum coupling point (nose weight)	150	150
Maximum vehicle and trailer combination	6,700	6,700
<b>ROOF CARRYING (kg)</b>		
Maximum roof load (including cross bars)	100	100

■ Standard.

\*With 22" wheel.

\*\*Weights reflect vehicles to standard specifications. Optional extras increase weight.

<sup>†</sup>Includes a 75kg driver, full fluids and 90% fuel.

<sup>††</sup>Includes full fluids and 90% fuel.

# DIMENSIONS AND CAPABILITIES

## STANDARD RIDE HEIGHT

With panoramic roof open (SWB/LWB)

1,874mm/1,880mm

With telematics roof antenna (SWB/LWB)

1,869mm/1,868mm

Access height air suspension setting will reduce each of the above by 50mm

## HEADROOM

Maximum front/rear headroom with panoramic roof

1,003mm/1,002mm (991mm LWB)

## LEGROOM

Maximum front legroom 994mm

Maximum rear legroom 997mm (LWB 1,189mm)

## LOADSPACE CAPACITY\*

Height 847mm, Width 1,291mm

Loadspace width between arches 1,120mm

Maximum loadspace volume behind first row (SWB/LWB)

Dry\*\* 1,694/1,990 litres, Wet† 2,190/2,470 litres

Maximum loadspace volume behind second row

Dry\*\* 707 litres, Wet† 900 litres

Maximum loadspace length behind first row (SWB/LWB)

1,982mm /2,073mm

Maximum loadspace length behind second row (SWB/LWB)

1,090mm/1,013mm

Executive seat reduces length behind row 2 by 80mm

PHEV reduces height by 46mm

## OBSTACLE CLEARANCE

Off-road height 297mm

Standard ride height 220mm

## TURNING CIRCLE

Kerb-to-kerb 12.3m (LWB 13.1m)

Wall-to-wall 12.7m (LWB 13.4m)

Turns lock-to-lock 3.03

## WADING DEPTH

Maximum wading depth 900mm††

Width 2,073mm mirrors folded

Width 2,220mm mirrors out

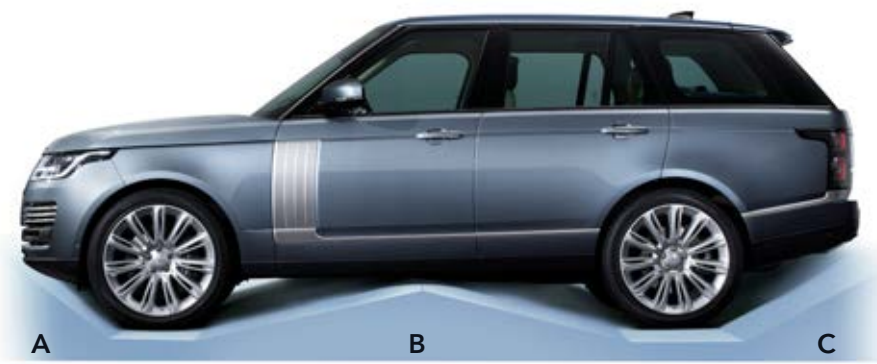
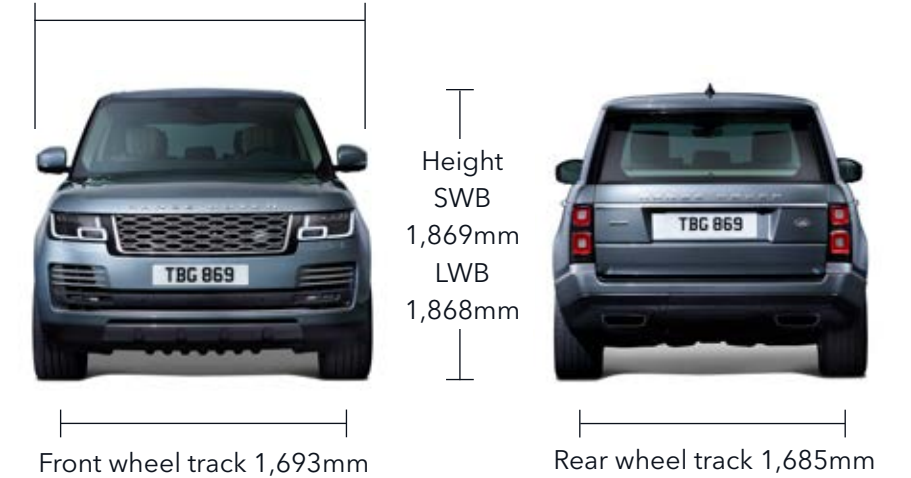

	A	B	C
Ride Height	Approach Angle	Ramp Angle	Departure Angle
Off-road (SWB/LWB)	34.7°	28.2°/25.6°	29.0°
Standard (SWB/LWB)	25.5°	21.5°/20.0°	24.5°



\*Rear loadspace capacity is reduced on P400e models. \*\*Dry: Volume as measured with VDA-compliant solid blocks (200mm x 50mm x 100mm).

†Wet: Volume as measured by simulating the loadspace filled with liquid.

††Wading depth (25 deg entry and exit) 750mm, Deep Forging depth (9 deg entry and exit) 900mm.

Figures shown may differ for P565 - 5.0L V8 Supercharged.

Please note: Figures relate to both Standard Wheelbase (SWB) and Long Wheelbase (LWB) models unless stated.