

**A1**



## The new Audi A1 Sportback.

A striking new profile, sharply defined lines and unique geometric design LED running lights. Whichever trim level you go for, with a high level of specification as standard and a whole host of innovative options and colour combinations to choose from, in the A1 Sportback, compact doesn't have to compromise.

Image for illustrative purposes only.

# Contents

This pricelist is designed to take you logically through the features and options available for the new Audi A1 Sportback. But if you'd like to go straight to a particular section, simply click on the relevant page number below.

## Page 4 Model choice

A1 Sportback SE **Page 4**  
A1 Sportback Sport **Page 6**  
A1 Sportback S line **Page 7**

A1 Sportback S line Competition **Page 8**  
A1 Sportback S line Style Edition **Page 9**  
A1 Sportback S line Contrast Edition **Page 10**

## Page 11 Model pricing

A1 Sportback SE **Page 11**  
A1 Sportback Sport **Page 11**  
A1 Sportback S line **Page 11**

A1 Sportback S line Competition **Page 12**  
A1 Sportback S line Style Edition **Page 12**  
A1 Sportback S line Contrast Edition **Page 12**

## Page 13 Paint

## Page 20 Seats

## Page 28 Comfort and Sound Pack

## Page 34 Financing your Audi

## Page 15 Contrast roof colours

## Page 23 Seat options

## Page 29 Technology Audio and communication

## Page 35 Technical data and dimensions

## Page 16 Wheels

## Page 24 Inlays and interior accents

## Page 30 Technology Driver assistance

Technical data  
A1 Sportback **Page 35**  
Dimensions  
A1 Sportback **Page 37**

## Page 18 Lighting

## Page 25 Interior equipment

## Page 32 Audi warranty

## Page 38 Important information

## Page 19 Exterior equipment

## Page 27 Technology Packs

## Page 33 Audi configurator

# A1 Sportback SE

## Key features that come as standard

The A1 offers a high level of specification as standard. On the exterior, sleek details such as LED headlights with LED rear lights and dynamic rear indicators and 15" alloy wheels create a striking look, while inside there's a 10.25" Digital Cockpit, 8.8" digital touch screen, Audi Smartphone Interface and a 3-spoke leather multi-function plus steering wheel.

### Wheels

- ▶ 15" x 6.0J '5-arm' design alloy wheels with 185/65 R15 tyres
- ▶ Tool kit
- ▶ Tyre repair kit

### Performance and suspension

- ▶ Automatic Start-Stop system
- ▶ Dynamic suspension
- ▶ Electro-mechanical power steering

### Lighting

- ▶ LED headlights with LED rear lights and dynamic rear indicators – all-weather headlights with dynamic headlight adjustment and dipped beam, high beam, indicators and turning light with LED technology. Enables near-daylight illumination of the road, minimum energy consumption and long service life. Includes LED daytime-running lights and dynamic rear indicators which sweep from inside to out. This helps to clearly identify not only that the vehicle is turning, but in which direction
- ▶ Rear fog lights

### Exterior equipment

- ▶ Radiator grille in Matt black
- ▶ Front side air inlets, front spoiler lip and rear diffuser in Matt black, grained
- ▶ Door mirrors – electrically adjustable and heated, with integrated LED side indicators
- ▶ Body-coloured door mirrors

### Seats

- ▶ Standard seats in Delta cloth
- ▶ Driver and passenger seat with manual height, forwards and backwards adjustment
- ▶ 3 rear seats with headrests
- ▶ Split-folding rear seat – can be split-folded 40:60 or folded fully

### Inlays

- ▶ Inlays in Polygon structure, black

### Interior equipment

- ▶ 3-spoke leather multi-function plus steering wheel – height and reach adjustable
- ▶ Leatherette handbrake grip
- ▶ Leather gear knob with aluminium trim
- ▶ Light and rain sensors
- ▶ Auto-dimming rear-view mirror
- ▶ Air vents, door handle recesses and centre console in black

- ▶ Headlining in Titanium grey cloth
- ▶ Electric front and rear windows
- ▶ Heat-insulating glass windscreen and side windows
- ▶ Front and rear floor mats
- ▶ Heated rear windscreen
- ▶ Centre console with 2 cupholders and 12V socket
- ▶ Interior lighting – front and rear reading lights and luggage compartment light
- ▶ Manual air conditioning
- ▶ Washer fluid level indicator

### Audio and communication

- ▶ 10.25" Digital Cockpit – the fully digital instrument cluster displays the 'Classic' style instrument dials, plus the following content:
  - ▶ Speed
  - ▶ Time
  - ▶ Odometer
  - ▶ Outside temperature
  - ▶ Fuel level warning with remaining range
  - ▶ Gear change recommendation (for manual transmissions and automatic transmissions in manual mode)
- ▶ Current radio station or music title, radio and media lists

- ▶ Telephone menu

The onboard computer supplies information about fuel consumption, remaining range, average speed, driving time and distance travelled. Including Attention Assist

- ▶ MMI Radio Plus with 8.8" MMI colour display screen and MMI Touch
- ▶ Audi Smartphone Interface\* – connects your compatible smartphone with your A1, bringing your mobile content via USB directly into the MMI display. Navigation, telephone, music and selected third-party apps can be easily controlled via the MMI controller and via the voice control system.
- ▶ Voice control system
- ▶ Bluetooth interface<sup>†</sup>
- ▶ DAB digital radio
- ▶ 6 passive loud speakers
- ▶ 1 SDXC card reader
- ▶ 1 USB-C and 1 USB-A charging points

\*Audi Smartphone Interface uses Apple CarPlay, which is available with iPhone 5 and above, or Android Auto, which is available with phones using Android 5.0 Lollipop or above and requires the download of the Android Auto app. Availability of applications differs by operating system and is dependent on approval by Apple or Google. An up-to-date list of approved apps is available on the relevant systems' websites. Permanent availability cannot be guaranteed as this is the responsibility of Apple and Google. Use of certain apps with Smartphone Interface will be subject to signal availability of the mobile network in your location and in-car usage may increase your mobile data usage. If using regularly, a mobile phone contract including an unlimited or high amount of data is recommended.

<sup>†</sup>For mobile phone and software version compatibility, please visit your Audi Centre or [www.audi.co.uk/phonecompatibility](http://www.audi.co.uk/phonecompatibility).

# A1 Sportback SE continued

## Driver assistance

- ▶ Audi Pre-sense Front with pedestrian and cyclist recognition – the system uses radar sensors to detect vehicles, cyclists and pedestrians in front. If an imminent collision is detected, the system warns the driver. The system may initiate emergency braking application (within system limits) and can also increase braking initiated by the driver (if this is inadequate) in order to reduce the severity of the collision, or if possible, prevent an accident
- ▶ Hill-hold assist – after the foot brake has been pressed with the vehicle stationary, the brake pressure that is built up is maintained for a short time after the brake is released and allows the driver to pull away smoothly uphill
- ▶ Lane departure warning – lane departure warning helps, within the system limits, to prevent unintentional departure from the lane. When the system is active and operational, and if the driver has not given a turn signal, the lane departure warning performs corrective steering interventions to prevent the vehicle crossing the lane boundary lines. The driver may select an additional steering wheel vibration if required. Operates at speeds greater than approximately 37mph
- ▶ Speed limiter – the speed limiter allows a maximum speed to be set. When the set limit is reached the vehicle gently decelerates. The driver can deactivate the speed limiter at any time or override the system by kick down (pressing on the accelerator pedal past the point of resistance)

## Safety and security

- ▶ Audi Connect Safety and Service including e-call – emergency call is triggered either manually, or automatically in the event of a serious accident, and establishes a voice call connection to local emergency services. In addition, vehicle related data is collated and sent to the local emergency services. The following Audi Connect Safety and Service features are also available:
  - ▶ Online roadside assistance for minor accidents and breakdowns
  - ▶ Audi Service request
  - ▶ Via the myAudi app you can also connect your vehicle to your smartphone to access:
    - ▶ Vehicle status report
    - ▶ Remote lock and unlock
    - ▶ Car finder
    - ▶ Theft alarm notificationFor more details, please speak to your Audi Centre\*
- ▶ Driver, front passenger, front side and head airbags
- ▶ Front passenger airbag deactivation switch
- ▶ Electronic Stabilisation Control (ESC) including ABS, EBD, ASR and EDL
- ▶ Tyre pressure warning light
- ▶ First aid kit with warning triangle
- ▶ ISOFIX child seat mounting for front passenger and outer rear seats – including Top Tether attachment point for the outer rear seats
- ▶ Seat belt monitoring
- ▶ Seat belt height adjustment for front seats
- ▶ Anti-theft alarm
- ▶ Anti-theft wheel bolts and loose wheel warning
- ▶ Remote central locking with 2 foldaway keys

\*Terms and condition apply, please see page 40.

Vehicle driver assistance and safety systems are not a substitute for attentive driving. Drivers retain full responsibility for providing the necessary inputs for safe control of the vehicle. System descriptions within this pricelist are provided for information purposes only. System limitations and operational requirements apply. See manual for details.

# A1 Sportback Sport

## Specification in addition or replacement to SE

For an even more dynamic impression, the Sport trim adds Sport styling, 16" alloy wheels and stylish aluminium interior inlays. Technology enhancements include cruise control, rear parking sensors and Audi Drive Select as standard.

### Wheels

- ▶ 16" x 6.5J '10-spoke turbine' design alloy wheels with 195/55 R16 tyres

### Performance and suspension

- ▶ Audi Drive Select – enables the driver to alter the power steering assistance, engine and gear-shift characteristics (S tronic only) between 3 preset modes: 'Auto', 'Dynamic', 'Efficiency' and an 'Individual' mode. The 'Efficiency' mode sets the engine, automatic transmission, air conditioning and cruise control systems to a more fuel-efficient basic setting

### Exterior equipment

- ▶ Radiator grille and rear diffuser in Matt titanium black
- ▶ Radiator protective grille frame in Matt aluminium silver
- ▶ Front side air inlets in Matt black, grained with C frame in Titanium black
- ▶ Side front spoiler lips in Matt black, grained

### Seats

- ▶ Front Sport seats in Novum cloth
- ▶ Manually adjustable lumbar support in front seats

### Inlays

- ▶ Inlays in Polygon structure, Slate grey, fine paint finish

### Interior equipment

- ▶ Accent areas in Silver grey, diamond paint finish
- ▶ Aluminium interior elements – interior details with aluminium finish in the following areas: air vent trim, electric window controls, door-mirror adjustment switches, handbrake lever button and frame around digital instrument panel
- ▶ Door sill trims with aluminium inlays

### Driver assistance

- ▶ Cruise control
- ▶ Rear parking sensors

# A1 Sportback S line

## Specification in addition or replacement to Sport

S line trim adds Sport suspension for firmer more dynamic handling, upgraded 17" alloy wheels, S line exterior bumpers, S line badging and the LED Interior Lighting Pack.

### Wheels

- ▶ 17" x 7.5J '5-twin-spoke' design alloy wheels, diamond-cut finish with 215/45 R17 tyres

### Performance and suspension

- ▶ Sport suspension

### Exterior equipment

- ▶ S line badges on front wings
- ▶ S line exterior styling:
  - ▶ S line exterior bumpers
  - ▶ Side air inlet frames in Titanium black
  - ▶ Front spoiler clip and rear diffuser clip in Matt platinum grey
- ▶ S line roof spoiler
- ▶ Body-coloured side sills

### Seats

- ▶ Front Sport seats in Pulse cloth/leatherette upholstery with embossed S logo and contrast stitching in Fine silver

### Inlays

- ▶ Inlays in Polygon structure, Silver grey, diamond paint finish

### Interior equipment

- ▶ 3-spoke leather multi-function plus steering wheel with S badging, grips in perforated leather and contrast stitching
- ▶ Accent areas in Structured grey, quartz paint finish
- ▶ Black cloth headlining
- ▶ Door sill trims with aluminium inlays and S logo
- ▶ Pedals in stainless steel
- ▶ LED Interior Lighting Pack – includes bulb lighting included as standard plus LED lighting in the following areas:
  - ▶ Front and rear roof module including reading lights
  - ▶ Illuminated vanity mirrors
  - ▶ Inside door handles
  - ▶ Front footwell lights
- ▶ Front and rear floor mats in black with contrast stitching in Fine silver

# A1 Sportback S line Competition

## Specification in addition or replacement to S line

With this trim, your new A1 doesn't just look sporty, it feels it too. Adorned with red brake calipers, contrasting door mirrors and bold tailpipes, the S line Competition signals intent. Paddles on the multi-function steering wheel allow for rapid gear changes; switch to a firmer suspension set-up and the dynamic, close-to-the-road feeling you'd normally expect of a sports car is complete.

### Wheels

- ▶ 17" x 7.5J '5-spoke' design alloy wheels in platinum grey, matt with 215/45 R17 tyres

### Performance and suspension

- ▶ Sport suspension with adjustable dampers – individually adjustable suspension characteristics which offer enhanced ride dynamics by adjusting to different driving situations. Two settings can be selected via Audi Drive Select: one offering more comfort for long distances or poor road surfaces, the other offering a sportier option with more rigid suspension/damper tuning for more direct road feel
- ▶ Red brake calipers

### Exterior equipment

- ▶ Door mirrors in Platinum grey
- ▶ Visible tailpipes
- ▶ Deletion of engine technology designation at rear
- ▶ Audi rings logo foil in Platinum grey

### Interior equipment

- ▶ 3-spoke leather multi-function plus steering wheel with paddles, S badging, grips in perforated leather and contrast stitching



# A1 Sportback S line Style Edition

## Specification in addition or replacement to S line

In this guise, the new A1 makes a statement that's hard to ignore. Larger wheels with striking, polished-bronze alloys set the scene; contrasting roof and body paints and privacy glass complete the look. Inside, accents in Satin copper tones continue the stylish design. And subtle, ambient LED lighting makes the cabin as attractive at night as it is during the day.

### Wheels

- ▶ 18" x 7.5J '5-spoke Y' design alloy wheels in bronze, partly polished with 215/40 R18 tyres

### Lighting

- ▶ Darkened LED headlights with LED rear lights and dynamic rear indicators

### Exterior equipment

- ▶ Exterior paint in Chronos grey, metallic (Z7) or Tioman green, solid (P3)
- ▶ Contrast roof in Mythos black (OE) or Manhattan grey (H1)^
- ▶ Exterior mirrors in contrast colour (matched to roof colour)
- ▶ Privacy glass – dark-tinted windows from B-pillar backwards
- ▶ Black Exterior Styling Pack – includes Audi rings front and rear, front grille, window trims and front and rear bumpers in black
- ▶ Audi rings logo foil in bronze

### Seats

- ▶ Front Sport seats in Twin leather upholstery with 2 cloth accents and contrasting stitching in copper

### Inlays

- ▶ Inlays in Polygon structure, Ferrum grey, fine paint finish

### Interior equipment

- ▶ LED Ambient Lighting Pack – multi-coloured
- ▶ Accent areas (air vents, door handle recesses and centre console) in copper, satin paint finish
- ▶ Door sill trims with aluminium inlays
- ▶ Armrests in leatherette with contrast stitching in copper
- ▶ Front and rear floor mats in black with contrast stitching in copper
- ▶ Pedals in black

<sup>^</sup>Manhattan grey only available in combination with Tioman green.

# A1 Sportback S line Contrast Edition

## Specification in addition or replacement to S line

It's in the name: with its arresting yellow bodywork and choice of black or grey roof, this edition turns the new A1 into a car of sharp contrasts. Fitted with larger, 18" alloy wheels and styled with black design details – including black Audi rings and darkened LED headlights – it's a small car with an immense presence.

### Wheels

- ▶ 18" x 7.5J '7-spoke Rotor' design alloy wheels in gloss anthracite black, diamond-cut finish with 215/40 R18 tyres

### Lighting

- ▶ Darkened LED headlights with LED rear lights and dynamic rear indicators

### Exterior equipment

- ▶ Exterior paint in Python yellow, metallic (R1)
- ▶ Contrast roof in Mythos black (OE) or Manhattan grey (H1)
- ▶ Exterior mirrors in contrast colour (matched to roof colour)
- ▶ Privacy glass – dark-tinted windows from B-pillar backwards
- ▶ Black Exterior Styling Pack – includes Audi rings front and rear, front grille, window trims and front and rear bumpers in black
- ▶ Audi rings logo foil in black

### Seats

- ▶ Front Sport seats in Frequency Alcantara/leatherette upholstery with S embossed logo and contrast stitching in Fine silver

## A1 Sportback SE

Engine	Fuel type	Power	Transmission	CO <sub>2</sub> g/km*	RRP inc VAT**	Recommended OTR**
30 TFSI	Petrol	116PS	6-speed manual	108	£17,710	£18,540
30 TFSI	Petrol	116PS	7-speed S tronic	108	£19,250	£20,080

## A1 Sportback Sport

Engine	Fuel type	Power	Transmission	CO <sub>2</sub> g/km*	RRP inc VAT**	Recommended OTR**
30 TFSI	Petrol	116PS	6-speed manual	111	£19,160	£20,010
30 TFSI	Petrol	116PS	7-speed S tronic	110	£20,700	£21,530
35 TFSI	Petrol	150PS	6-speed manual	119	£20,240	£21,090
35 TFSI	Petrol	150PS	7-speed S tronic	115	£21,780	£22,630

## A1 Sportback S line

Engine	Fuel type	Power	Transmission	CO <sub>2</sub> g/km*	RRP inc VAT**	Recommended OTR**
30 TFSI	Petrol	116PS	6-speed manual	111	£20,810	£21,660
30 TFSI	Petrol	116PS	7-speed S tronic	110	£22,350	£23,180
35 TFSI	Petrol	150PS	6-speed manual	119	£21,890	£22,740
35 TFSI	Petrol	150PS	7-speed S tronic	116	£23,430	£24,280

\*Figures shown are for comparability purposes; only compare fuel consumption and CO<sub>2</sub> figures with other vehicles tested to the same technical procedures. These figures may not reflect real life driving results, which will depend upon a number of factors including the accessories fitted (post-registration), variations in weather, driving styles and vehicle load. There is a new test used for fuel consumption and CO<sub>2</sub> figures (known as WLTP). The CO<sub>2</sub> figures shown however, are based on a calculation designed to be equivalent to the outgoing (NEDC) test cycle and will be used to calculate vehicle tax on first registration. For more information, please see [audi.co.uk/wltp](http://audi.co.uk/wltp) or consult your Audi Centre. Data correct at date of publication. The CO<sub>2</sub> emissions figures quoted on this page are for standard specification. Please see page 36 for the range of values for this model (inclusive of optional wheels).

\*\*Total RRP inc VAT – Recommended Retail Price including VAT which is calculated at 20%. This may alter to reflect any change in the applicable VAT rate. Please see page 38 for explanation on Recommended On-The-Road (OTR) retail prices and VED rates.

## A1 Sportback S line Competition

Engine	Fuel type	Power	Transmission	CO <sub>2</sub> g/km*	RRP inc VAT**	Recommended OTR**
40 TFSI	Petrol	200PS	7-speed S tronic	136	£24,470	£25,360

## A1 Sportback S line Style Edition

Engine	Fuel type	Power	Transmission	CO <sub>2</sub> g/km*	RRP inc VAT**	Recommended OTR**
35 TFSI	Petrol	150PS	6-speed manual	120	£24,805	£25,655
35 TFSI	Petrol	150PS	7-speed S tronic	116	£26,345	£27,195







## A1 Sportback S line Contrast Edition

Engine	Fuel type	Power	Transmission	CO <sub>2</sub> g/km*	RRP inc VAT**	Recommended OTR**
35 TFSI	Petrol	150PS	6-speed manual	120	£24,805	£25,655
35 TFSI	Petrol	150PS	7-speed S tronic	116	£26,345	£27,195

\*Figures shown are for comparability purposes; only compare fuel consumption and CO<sub>2</sub> figures with other vehicles tested to the same technical procedures. These figures may not reflect real life driving results, which will depend upon a number of factors including the accessories fitted (post-registration), variations in weather, driving styles and vehicle load. There is a new test used for fuel consumption and CO<sub>2</sub> figures (known as WLTP). The CO<sub>2</sub> figures shown however, are based on a calculation designed to be equivalent to the outgoing (NEDC) test cycle and will be used to calculate vehicle tax on first registration. For more information, please see [audi.co.uk/wltp](http://audi.co.uk/wltp) or consult your Audi Centre. Data correct at date of publication. The CO<sub>2</sub> emissions figures quoted on this page are for standard specification. Please see page 36 for the range of values for this model (inclusive of optional wheels).

\*\*Total RRP inc VAT – Recommended Retail Price including VAT which is calculated at 20%. This may alter to reflect any change in the applicable VAT rate. Please see page 38 for explanation on Recommended On-The-Road (OTR) retail prices and VED rates.

# Paint



			SE	Sport	S line	S line Competition	S line Style Edition	S line Contrast Edition	Total RRP inc VAT <sup>+</sup>
B4		Shell white, solid	•	•	•	•	-	-	£0
H1		Manhattan grey, metallic	•	•	-	-	-	-	£575
5U		Firmament blue, metallic	•	•	-	-	-	-	£575
2Y		Glacier white, metallic	•	•	•	•	-	-	£575
0E		Mythos black, metallic	•	•	•	•	-	-	£575
R1		Python yellow, metallic	•	•	•	•	-	S	£575
N9		Misano red, pearl effect	•	•	•	•	-	-	£575

Options are subject to availability and may extend time taken for delivery. Choice of options may affect fuel consumption data – please see page 36 for further information. All the colour swatches on this page are matched as accurately as possible to the actual paint colours used. Audi UK cannot guarantee that colours shown are 100% accurate. Visit your local Audi Centre for a more accurate colour swatch.

<sup>+</sup>Total RRP inc VAT – Recommended Retail Price including VAT which is calculated at 20%. This may alter to reflect any change in the applicable VAT rate.

- = Not available • = Available S = Standard

# Paint continued

			SE	Sport	S line	S line Competition	S line Style Edition	S line Contrast Edition	Total RRP inc VAT <sup>+</sup>
P3		Tioman green, solid	•	•	•	•	S	-	£575
N6		Turbo blue, solid	-	-	•	•	-	-	£575
Z7		Chronos grey, metallic	-	-	•	•	S	-	£575

Options are subject to availability and may extend time taken for delivery. Choice of options may affect fuel consumption data – please see page 36 for further information. All the colour swatches on this page are matched as accurately as possible to the actual paint colours used. Audi UK cannot guarantee that colours shown are 100% accurate. Visit your local Audi Centre for a more accurate colour swatch.

<sup>+</sup>Total RRP inc VAT – Recommended Retail Price including VAT which is calculated at 20%. This may alter to reflect any change in the applicable VAT rate.

- = Not available • = Available S = Standard

# Contrast roof colours

			SE	Sport	S line	S line Competition	S line Style Edition	S line Contrast Edition	Total RRP inc VAT <sup>+</sup>
6H4		Contrast roof in Mythos black, metallic (OE)	•	•	•	•	S	S	£425*
6H4		Contrast roof in Manhattan grey, metallic (H1)	•	•	•	•	S <sup>^</sup>	S	£425*

# Roof colour combinations

Body colour		Roof colours	
		Mythos black, metallic	Manhattan grey, metallic
B4	Shell white, solid	-	-
H1	Manhattan grey, metallic	•	-
5U	Firmament blue, metallic	•	•
2Y	Glacier white, metallic	•	•
0E	Mythos black, metallic	-	•
R1	Python yellow, metallic	•	•
N9	Misano red, pearl effect	•	•
P3	Tioman green, solid	•	•
N6	Turbo blue, solid	•	•
Z7	Chronos grey, metallic	•	-









Options are subject to availability and may extend time taken for delivery. Choice of options may affect fuel consumption data – please see page 36 for further information. All the colour swatches on this page are matched as accurately as possible to the actual paint colours used. Audi UK cannot guarantee that colours shown are 100% accurate. Visit your local Audi Centre for a more accurate colour swatch. <sup>^</sup>Only in conjunction with Tioman green, solid.

\*Pricing excludes exterior paint price. For body colour restrictions by trim and body paint pricing, please see pages 13 and 14.

<sup>+</sup>Total RRP inc VAT – Recommended Retail Price including VAT which is calculated at 20%. This may alter to reflect any change in the applicable VAT rate.

- = Not available • = Available S = Standard

# Wheels

			SE	Sport	S line	S line Competition	S line Style Edition	S line Contrast Edition	Total RRP inc VAT <sup>+</sup>
C3V		<b>15" x 6.0J '5-arm' design alloy wheels</b> with 185/65 R15 tyres	S	-	-	-	-	-	£0
C2P		<b>16" x 6.5J '10-spoke turbine' design alloy wheels</b> with 195/55 R16 tyres	-	S	-	-	-	-	£0
C2D		<b>16" x 6.5J '10-spoke' design alloy wheels</b> with 195/55 R16 tyres	-	•	-	-	-	-	£250
CP4		<b>17" x 7.5J '5-arm Star' design alloy wheels</b> with 215/45 R17 tyres	-	•	-	-	-	-	£750
CJ1		<b>17" x 7.5J '5-twin-spoke' design alloy wheels, diamond-cut finish</b> with 215/45 R17 tyres	-	-	S	-	-	-	£0
COU		<b>17" x 7.5J '5-spoke' design alloy wheels in platinum grey, matt</b> with 215/45 R17 tyres	-	-	-	S	-	-	£0
CQ6		<b>17" x 7.5J '5-spoke V' design alloy wheels, diamond-cut finish</b> with 215/45 R17 tyres	-	-	•	•	-	-	£250
CP3		<b>17" x 7.5J '5-spoke' design alloy wheels in black</b> with 215/45 R17 tyres	-	-	•	-	-	-	£250

Options are subject to availability and may extend time taken for delivery.

Choice of wheels and other options may affect fuel consumption and emissions data. This may lead to a change to the Vehicle Excise Duty (VED) amount payable. Please refer to pages 36 and 38.

<sup>+</sup>Total RRP inc VAT – Recommended Retail Price including VAT which is calculated at 20%. This may alter to reflect any change in the applicable VAT rate.

- = Not available • = Available S = Standard



# Wheels continued

			SE	Sport	S line	S line Competition	S line Style Edition	S line Contrast Edition	Total RRP inc VAT <sup>+</sup>
CF9		<b>18" x 7.5J '5-Y-spoke' design alloy wheels in contrasting grey, diamond-cut finish</b> with 215/40 R18 tyres	-	-	•	•	-	-	£750
C2K		<b>18" x 7.5J '5-spoke Y' design alloy wheels in bronze, partly polished</b> with 215/40 R18 tyres	-	-	-	-	S	-	£0
CV1		<b>18" x 7.5J '7-spoke Rotor' design alloy wheels in gloss anthracite black, diamond-cut finish</b> with 215/40 R18 tyres	-	-	-	-	-	S	£0
1G9 1S1		<b>Space-saving spare wheel – including car jack</b> Only in combination with Luggage Compartment Pack (3GD)	•	•	•	•	•	•	£125

Options are subject to availability and may extend time taken for delivery.

Choice of wheels and other options may affect fuel consumption and emissions data. This may lead to a change to the Vehicle Excise Duty (VED) amount payable. Please refer to pages 36 and 38.

<sup>+</sup>Total RRP inc VAT – Recommended Retail Price including VAT which is calculated at 20%. This may alter to reflect any change in the applicable VAT rate.

- = Not available • = Available S = Standard

# Lighting

		SE	Sport	S line	S line Competition	S line Style Edition	S line Contrast Edition	Total RRP inc VAT <sup>+</sup>
8G1	<p><b>High-beam assist</b>                      Within system limits, high-beam assist detects the headlights of oncoming traffic, the rear lights of other road users and light sources in built-up areas. Depending on the traffic situation, the high beam automatically adjusts to dipped beam and vice versa. The system improves the driver's visibility and brings added comfort and convenience</p>	•	•	•	•	•	•	£135

Options are subject to availability and may extend time taken for delivery. Choice of options may affect fuel consumption data – please see page 36 for further information.  
<sup>+</sup>Total RRP inc VAT – Recommended Retail Price including VAT which is calculated at 20%. This may alter to reflect any change in the applicable VAT rate.

– = Not available • = Available S = Standard

# Exterior equipment

		SE	Sport	S line	S line Competition	S line Style Edition	S line Contrast Edition	Total RRP inc VAT <sup>+</sup>
4KF	<b>Privacy glass</b> Dark-tinted rear and rear-side windows from B-pillar backwards	-	•	•	•	S	S	£375
6XE	<b>Door mirrors (folding)</b> Electrically folding, electrically adjustable and heated, with integrated LED side indicators and including kerb-view function for passenger side	•	•	•	•	•	•	£150
2Z0	<b>Deletion of model and technology designation at rear</b>	•	•	•	•	•	•	£0
2Z7	<b>Deletion of engine technology designation at rear</b>	•	•	•	S	•	•	£0

Options are subject to availability and may extend time taken for delivery. Choice of options may affect fuel consumption data – please see page 36 for further information.  
<sup>+</sup>Total RRP inc VAT – Recommended Retail Price including VAT which is calculated at 20%. This may alter to reflect any change in the applicable VAT rate.

- = Not available • = Available S = Standard

# Standard seats Q1A

Although referred to as standard, there really is nothing ordinary or standard about this seat. Comfortable, stylish and available as standard in Delta cloth. Seat functionality includes manual adjustment for seat height for the driver and passenger, forwards/backwards position, backrest angle, headrests and seat belt height.

		SE	Sport	S line	S line Competition	S line Style Edition	S line Contrast Edition	Total RRP inc VAT <sup>+</sup>
NOB	<b>Standard seats with Delta cloth.</b> Delta cloth in seat centre panels and seat side bolsters. Door trim inserts in black. Centre armrest (if ordered) in black single-colour cloth	S	-	-	-	-	-	£0
<b>Standard seats colour choice</b>							<b>Delta cloth</b>	
YM	<b>Black upholstery with black stitching.</b> Headlining in Titanium grey. Upper and lower dashboard in black. Carpet in black						•	

Options are subject to availability and may extend time taken for delivery. Choice of options may affect fuel consumption data – please see page 36 for further information.  
<sup>+</sup>Total RRP inc VAT – Recommended Retail Price including VAT which is calculated at 20%. This may alter to reflect any change in the applicable VAT rate.

– = Not available • = Available S = Standard

# Front Sport seats Q4H

Front Sport seats not only have a Sport design but also offer a firmer and more supported driving position with prominent side bolsters which improve lateral support. Seat functionality includes manual adjustment for seat height for the driver and passenger, 2-way lumbar support, seat forwards/backwards position, backrest angle, headrest and seat belt height.

		SE	Sport	S line	S line Competition	S line Style Edition	S line Contrast Edition	Total RRP inc VAT <sup>+</sup>
NOL	<b>Front Sport seats with Novum cloth.</b> Novum cloth in seat centre panels. Single-colour Granite grey cloth with contrast stitching on front seat side bolsters. Single-colour black cloth with contrast stitching on rear seat side bolsters. Front centre armrest (if ordered) in black single-colour cloth. Door trims in black	-	S	-	-	-	-	£0
N4M	<b>Front Sport seats with Twin leather.</b> A combination trim offering the comfort and style of leather without the higher cost. For maximum durability, real leather in Titanium grey is applied in the following areas: seat centre panels on the front seats, driver's seat bolster (entrance side only) and seat centre panels on the 2 rear seats. Leatherette trim in Titanium grey is applied on the headrests, front seat side bolsters, front centre armrest (if ordered) and middle rear seat. Leatherette trim in Granite grey is applied on rear seat side bolsters. Includes feature strips in grey cloth and contrasting stitching in copper. Door trims in black. Door armrest in black artificial leather and floor mats in black with contrasting stitching in copper	-	-	-	-	S	-	£0

Front Sport seats colour choices		Novum cloth	Twin leather
ZV	<b>Granite grey upholstery with Steel grey stitching.</b> Headlining in Titanium grey. Upper and lower dashboard in black. Carpet in black	•	-
KF	<b>Granite grey upholstery with Mint contrast panels and stitching.</b> Headlining in Titanium grey. Upper and lower dashboard in black. Carpet in black	•	-
KW	<b>Titanium grey upholstery with copper stitching.</b> Headlining in black. Upper and lower dashboard in black. Carpet in black	-	•

Options are subject to availability and may extend time taken for delivery. Choice of options may affect fuel consumption data – please see page 36 for further information.  
<sup>+</sup>Total RRP inc VAT – Recommended Retail Price including VAT which is calculated at 20%. This may alter to reflect any change in the applicable VAT rate.

- = Not available • = Available S = Standard

# Front Sport seats with S embossed logo Q4H

Unique to S line and an upgrade on Front Sport seats, these seats come with S embossing on the front seat backs. The seats not only have a Sport design, but also offer a firmer and more supported driving position with prominent side bolsters which improve lateral support. Seat functionality includes manual adjustment for seat height for the driver and passenger, 2-way lumbar support, seat forwards/backwards position, backrest angle, headrest and seat belt height.

		SE	Sport	S line	S line Competition	S line Style Edition	S line Contrast Edition	Total RRP inc VAT <sup>+</sup>
N7V	<b>Front Sport seats with Pulse cloth/leatherette.</b> Pulse cloth in front and outer rear seat centre panels with 2 feature silver cloth stripes. Seat side bolsters, headrests, middle seat and front centre armrest (if ordered) in black leatherette with contrast stitching. Door trims in black	-	-	S	S	-	-	£0
N7K	<b>Front Sport seats with Frequency Alcantara/leatherette.</b> Alcantara with an embossed pattern and contrast stitching enhances the styling of your seats, offers additional grip for sportier driving and at the same time provides added comfort across the seasons. Front and outer rear seat centres in Alcantara. Seat side bolsters, headrest and front centre armrest (if ordered) in black leatherette with contrast stitching. Also includes 2 feature Alcantara strips in Rock grey. Door trims in black	-	-	•	•	-	S	£600
<b>Front Sport seats with S embossed logo colour choice</b>					<b>Pulse cloth/leatherette</b>		<b>Frequency Alcantara/leatherette</b>	
TV	<b>Black upholstery with Fine silver stitching.</b> Headlining in black. Upper and lower dashboard in black. Carpet in black				•		•	

Options are subject to availability and may extend time taken for delivery. Choice of options may affect fuel consumption data – please see page 36 for further information.  
<sup>+</sup>Total RRP inc VAT – Recommended Retail Price including VAT which is calculated at 20%. This may alter to reflect any change in the applicable VAT rate.

- = Not available • = Available S = Standard







# Seat options

		SE	Sport	S line	S line Competition	S line Style Edition	S line Contrast Edition	Total RRP inc VAT <sup>+</sup>
4A3	Heated front seats	•	•	•	•	•	•	£300

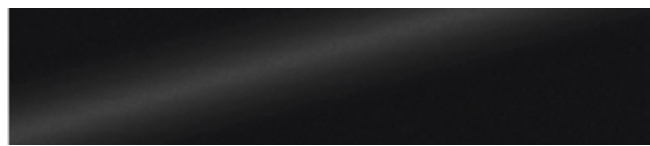
Options are subject to availability and may extend time taken for delivery. Choice of options may affect fuel consumption data – please see page 36 for further information.  
<sup>+</sup>Total RRP inc VAT – Recommended Retail Price including VAT which is calculated at 20%. This may alter to reflect any change in the applicable VAT rate.

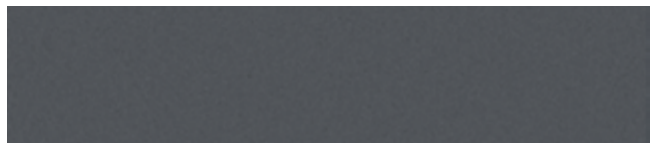
– = Not available • = Available **S** = Standard

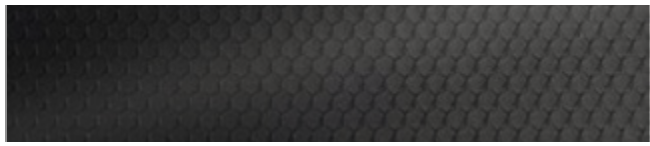
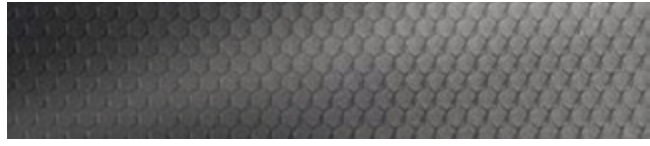
# Inlays and interior accents

			SE	Sport	S line	S line Competition	S line Style Edition	S line Contrast Edition	Total RRP inc VAT <sup>+</sup>
0UA		<b>Accent areas in black</b> For air vents, centre console and interior door handle recesses	S	-	-	-	-	-	£0
0UK		<b>Accent areas in Silver grey, diamond paint finish</b> For air vents, centre console and interior door handle recesses	-	S	-	-	-	-	£0
0UL		<b>Accent areas in Structured grey, quartz paint finish</b> For air vents, centre console and interior door handle recesses	-	-	S	S	-	S	£0
0UF		<b>Accent areas in copper, satin paint finish</b> For air vents, centre console and interior door handle recesses	-	-	-	-	S	-	£0
5MA		<b>Inlays in Polygon structure, black</b>	S	-	-	-	-	-	£0
5MB		<b>Inlays in Polygon structure, Slate grey, fine paint finish</b>	-	S	-	-	-	-	£0
5MJ		<b>Inlays in Polygon structure, Silver grey, diamond paint finish</b>	-	-	S	S	-	S	£0
5MC		<b>Inlays in Polygon structure, Ferrum grey, fine paint finish</b>	-	-	-	-	S	-	£0

Options are subject to availability and may extend time taken for delivery. Choice of options may affect fuel consumption data – please see page 36 for further information. All the inlay swatches on this page are matched as accurately as possible to the actual inlay colours used. Audi UK cannot guarantee that colours shown are 100% accurate. Visit your local Audi Centre for a more accurate colour swatch.

<sup>+</sup>Total RRP inc VAT – Recommended Retail Price including VAT which is calculated at 20%. This may alter to reflect any change in the applicable VAT rate.

-- = Not available • = Available S = Standard



# Interior equipment

		SE	Sport	S line	S line Competition	S line Style Edition	S line Contrast Edition	Total RRP inc VAT <sup>+</sup>
9AK	<b>Dual-zone electronic climate control</b> Separate controls to set exact temperatures for the driver and front passenger. Electronically regulates the air temperature, air flow rate and air distribution. Automatic recirculation mode using an air quality sensor, combined filter, rear vents and humidity regulation for more efficient climate control	•	•	•	•	•	•	£450
QE1	<b>Storage Pack</b> Includes the following items: ▶ Storage compartment under front passenger seat ▶ Lockable glove compartment ▶ Driver and front-passenger seat storage bags ▶ Logbook holder under driver seat	•	•	•	•	•	•	£125
QQ1	<b>LED Interior Lighting Pack</b> Includes bulb lighting included as standard plus LED lighting in the following areas: ▶ Front and rear roof module including reading lights ▶ Illuminated vanity mirrors ▶ Inside door handles ▶ Front footwell lights	•	•	S	S	-	S	£150
QQ2	<b>LED Ambient Lighting Pack – multi-coloured</b> In addition to the LED Interior Lighting Pack (QQ1) includes coloured ambient lighting in the following areas: ▶ Front door contour lighting ▶ Ambient spot lighting in the front doors ▶ Illuminated storage compartment below instrument panel ▶ Body vent contour lighting on driver side. A selection of 30 colours is available	-	-	•	•	S	•	£150
3GD	<b>Luggage Compartment Pack</b> Loading floor and nets in luggage compartment	•	•	•	•	•	•	£50
6E3	<b>Front centre armrest</b> Angle adjustable, fold-up storage compartment	•	•	•	•	•	•	£150

Options are subject to availability and may extend time taken for delivery. Choice of options may affect fuel consumption data – please see page 36 for further information.  
<sup>+</sup>Total RRP inc VAT – Recommended Retail Price including VAT which is calculated at 20%. This may alter to reflect any change in the applicable VAT rate.

- = Not available • = Available S = Standard

# Interior equipment continued

		SE	Sport	S line	S line Competition	S line Style Edition	S line Contrast Edition	Total RRP inc VAT <sup>+</sup>
2PF	<b>Flat-bottomed 3-spoke leather multi-function plus steering wheel</b> Control of onboard computer, telephone, radio and navigation system (if fitted) with both hands on the steering wheel. Height and reach-adjustable, with full-size airbag. S line trim features S badging on the steering wheel, grips in perforated leather and contrast stitching	-	•	•	-	•	•	£250
2PK	<b>Flat-bottomed 3-spoke leather multi-function plus steering wheel, with paddles for S tronic transmissions</b> Control of onboard computer, telephone, radio and navigation system (if fitted) with both hands on the steering wheel. Height and reach-adjustable, with full-size airbag. S line trim features S badging on the steering wheel, grips in perforated leather and contrast stitching	-	•	•	•	•	•	£250

Options are subject to availability and may extend time taken for delivery. Choice of options may affect fuel consumption data – please see page 36 for further information.  
<sup>+</sup>Total RRP inc VAT – Recommended Retail Price including VAT which is calculated at 20%. This may alter to reflect any change in the applicable VAT rate.

- = Not available • = Available S = Standard

# Technology Packs

## Technology Pack

This pack brings together the most popular technology options that are frequently ordered together for those wanting the highest level of connectivity and navigation.

### MMI Navigation Plus with MMI Touch

The following contents in addition to MMI Radio Plus:

- ▶ Navigation system on a high-resolution 10.1" colour display
- ▶ Advanced 3D city models with realistic building texture and road lane illustration for selected cities
- ▶ Entry of up to 10 interim destinations
- ▶ Detailed route information: map preview, alternative route selection, POI's, lane recommendations, motorway exits, detailed junction maps and more
- ▶ Online map update (includes 5 free updates)
- ▶ Personal route assistance: (when enabled) monitors the traffic situation on regularly travelled routes – for example between home and work – offering route calculation to avoid traffic jams in the event of delays of 7 minutes or more
- ▶ TMC traffic information
- ▶ MMI search: free text search with intelligent suggestions during entry

- ▶ MMI Touch for fast, intuitive operation, e.g. destination entry with handwriting recognition and free movement/zooming of map
- ▶ Easy-to-use infotainment with natural Voice recognition
- ▶ Use of navigation data for predictive and efficient driving, e.g. speed limits and inclines
- ▶ Country information: display of information, e.g. speed limits, tax stickers etc. when crossing borders

### Audi Virtual Cockpit

Innovative 10.25" full-colour digital instrument cluster for the flexible display of information tailored to the driver's needs. As well as the features available on the digital cockpit, Audi Virtual Cockpit also displays the following:

- ▶ Audi Connect Services
- ▶ 3D navigation map and display of navigation information
- ▶ Driver assistance systems (when ordered as options)

The 'view' button on the multi-function steering wheel allows you to change between the 2 differently sized representations of the instrument dials. The 'Sport' display with small instruments allows the onboard computer and MMI contents to be shown across the full display area

### Audi Connect Infotainment Services (36-month subscription)

In addition to the standard Audi Connect Safety and Service, provides a convenient high-speed 4G internet access in your car via an embedded SIM card with no data charge. Audi Connect supports the following services:

- ▶ Navigation with Google Earth™
- ▶ POI search with voice control
- ▶ Travel information
- ▶ Destination input by means myAudi or Google Maps™
- ▶ Traffic information online
- ▶ Parking information
- ▶ Messages

- ▶ Email
  - ▶ Calendar
  - ▶ Access to Twitter
  - ▶ News online (individual)
  - ▶ Fuel prices
  - ▶ Weather
  - ▶ myAudi special destinations
  - ▶ Country information
  - ▶ Online media streaming display area
- For more details, please speak to your Audi Centre\*

### Audi Phone Box with wireless charging

Offers wireless charging (with Qi-enabled compatible phones) and creates an additional Bluetooth interface for a second device, meaning 2 mobile phones can be connected to the vehicle simultaneously. For mobile phone and software version compatibility, please visit your Audi Centre or [www.audi.co.uk/phonecompatibility](http://www.audi.co.uk/phonecompatibility)

		SE	Sport	S line	S line Competition	S line Style Edition	S line Contrast Edition	Total RRP inc VAT <sup>+</sup>
WB4	<b>Technology Pack</b>	-	•	•	•	•	•	£1,650

Options are subject to availability and may extend time taken for delivery. Choice of options may affect fuel consumption data – please see page 36 for further information.

\*Terms and conditions apply, please see pages 39 and 40.

<sup>+</sup>Total RRP inc VAT – Recommended Retail Price including VAT which is calculated at 20%. This may alter to reflect any change in the applicable VAT rate.

- = Not available • = Available S = Standard

# Comfort and Sound Pack WF5

A pack that adds value by combining some of our most popular options – designed to improve comfort and enhance your sound experience.

### Bang & Olufsen 3D Sound System

Surround sound reproduction via 11 high-performance speakers including centre speaker, subwoofer and a 12-channel amplifier with a total output of 560 watts. Spatial sound reproduction through the new 3D sound feature for the front seats. Exclusive speaker covers with aluminium applications. The sound is permanently adapted to compensate for driving and background noises determined by a microphone

### Audi Parking System Plus

Acoustic and visual park assist system for the front and rear with MMI screen display showing a graphical representation of the distance to any obstacles detected outside and within the driving path. Measurement is by ultrasonic sensors concealed in the bumpers

### Heated front seats

Heating for seat and backrest centre panels, and also the seat side bolsters. Individually adjustable in several stages for driver and front passenger side via the air conditioning controls

		SE	Sport	S line	S line Competition	S line Style Edition	S line Contrast Edition	Total RRP inc VAT*
WF5	<b>Comfort and Sound Pack</b> Only in combination with Luggage Compartment Pack (3GD)	-	•	•	•	•	•	£995

Options are subject to availability and may extend time taken for delivery. Choice of options may affect fuel consumption data – please see page 36 for further information.

\*Total RRP inc VAT – Recommended Retail Price including VAT which is calculated at 20%. This may alter to reflect any change in the applicable VAT rate.

– = Not available • = Available S = Standard

# Technology Audio and communication

		SE	Sport	S line	S line Competition	S line Style Edition	S line Contrast Edition	Total RRP inc VAT <sup>+</sup>
9VD	<b>Audi Sound System</b> Impressive sound with 8 loudspeakers including centre speaker and subwoofer, 6-channel amplifier with a total output of 180 watts. Only in combination with Luggage Compartment Pack (3GD)	-	•	•	•	•	•	£255

Options are subject to availability and may extend time taken for delivery. Choice of options may affect fuel consumption data – please see page 36 for further information.  
<sup>+</sup>Total RRP inc VAT – Recommended Retail Price including VAT which is calculated at 20%. This may alter to reflect any change in the applicable VAT rate.

-- = Not available • = Available S = Standard

# Technology Driver assistance

		SE	Sport	S line	S line Competition	S line Style Edition	S line Contrast Edition	Total RRP inc VAT <sup>+</sup>
KA2	<p><b>Rear-view camera</b> An image of the area behind the vehicle, within system limits, is shown on the MMI display with dynamic display modes highlighting the calculated path (steer-angle dependent). Reversing camera is concealed in the handle of the luggage compartment lid. Enabled when the reverse gear is selected, or via a button in the centre console. Only in combination with Audi Parking System Plus (7X2), Park assist (7X5) or Comfort and Sound Pack (WF5)</p>	-	•	•	•	•	•	£350
7X1	<p><b>Rear parking sensors</b> The rear parking system aids reverse parking and manoeuvring within system limits, with acoustic indication of the distance to an object detected behind the vehicle. Measurement is via ultrasonic sensors discreetly integrated into the bumpers, which are activated by engaging the reverse gear</p>	•	S	S	S	S	S	£400
7X2	<p><b>Audi Parking System Plus</b> Acoustic and visual park assist system for the front and rear with MMI screen display showing a graphical representation of the distance to any obstacles detected outside and within the driving path. Measurement is by ultrasonic sensors concealed in the bumpers. Enabled by selecting the reverse gear, via a button in the centre console, or even automatically, when an approximate distance below 90cm to an object is detected. Also available within Comfort and Sound Pack (WF5)</p>	-	•	•	•	•	•	£325
7X5	<p><b>Park assist</b> Searches for suitable parking spaces along the road by means of ultrasonic sensors, calculates the ideal parking path and performs the steering action virtually automatically. The system can support the driver with: ▶ Parallel parking in reverse ▶ Exiting a parallel parking space, driving forwards ▶ Bay parking, both reverse and forwards Steering is done by the vehicle with the driver responsible for acceleration, gear changes and application of brakes</p>	-	•	•	•	•	•	£450

Options are subject to availability and may extend time taken for delivery. Choice of options may affect fuel consumption data – please see page 36 for further information.  
Vehicle driver assistance and safety systems are not a substitute for attentive driving. Drivers retain full responsibility for providing the necessary inputs for safe control of the vehicle.  
System descriptions within this pricelist are provided for information purposes only. System limitations and operational requirements apply. See manual for details.  
<sup>+</sup>Total RRP inc VAT – Recommended Retail Price including VAT which is calculated at 20%. This may alter to reflect any change in the applicable VAT rate.

-- = Not available • = Available S = Standard

# Technology Driver assistance continued

		SE	Sport	S line	S line Competition	S line Style Edition	S line Contrast Edition	Total RRP inc VAT <sup>+</sup>
PCG	<p><b>Adaptive Speed Assist</b> Automatic distance regulation, using radar sensors to maintain the required distance between vehicles ahead by braking and accelerating. Approximate control range for manual transmissions 18-124mph.* On S tronic transmissions it includes Stop&amp;Go function which brakes the car to a stop and can restart automatically again (subject to certain system limits). Approximate control range for S tronic transmissions 0-124mph.* Controlled via a separate steering column stalk. The distance can be adjusted in 5 intervals, configurable by the ASA menu</p>	-	•	•	•	•	•	£300
PG3	<p><b>Advanced key</b> Access and authorisation system that works through automatic data exchange between key and vehicle, allowing the driver to keep the car key in their pocket or bag at all times. To unlock and open, simply pull the exterior door handle. Pressing the start/stop button integrated in the centre console starts and stops the engine</p>	-	•	•	•	•	•	£400

Options are subject to availability and may extend time taken for delivery. Choice of options may affect fuel consumption data – please see page 36 for further information. Vehicle driver assistance and safety systems are not a substitute for attentive driving. Drivers retain full responsibility for providing the necessary inputs for safe control of the vehicle. System descriptions within this pricelist are provided for information purposes only. System limitations and operational requirements apply. See manual for details.

\*Where the law permits.

<sup>+</sup>Total RRP inc VAT – Recommended Retail Price including VAT which is calculated at 20%. This may alter to reflect any change in the applicable VAT rate.

– = Not available • = Available S = Standard

# Audi warranty

All new Audi models come with a 3-year warranty as standard, and you can choose to extend this to a 4 or 5-year warranty\* for a one-off cost. What's more, if you decide to sell your Audi before the warranty expires, it will be fully transferred to the new owner. Warranty terms and conditions apply. Please see [www.audi.co.uk/warrantyterms](http://www.audi.co.uk/warrantyterms) for further details.

		SE	Sport	S line	S line Competition	S line Style Edition	S line Contrast Edition	Total RRP inc VAT <sup>†</sup>
-	<b>Audi warranty</b> , covering you for unlimited mileage in the first 2 years of ownership, and up to 60,000 miles in the third year. Transferable between owners <sup>^</sup>	S	S	S	S	S	S	£0
EA6	<b>Audi warranty</b> , covering you for up to 4 years or 75,000 miles, whichever comes sooner. Cover includes a 2-year unlimited-mileage warranty, and up to 75,000 miles in the third and fourth years. Transferable between owners <sup>^</sup>	•	•	•	•	•	•	£275
EA9	<b>Audi warranty</b> , covering you for up to 5 years or 90,000 miles, whichever comes sooner. Cover includes a 2-year unlimited-mileage warranty, and up to 90,000 miles in the third, fourth and fifth years. Transferable between owners <sup>^</sup>	•	•	•	•	•	•	£565

\*3-year warranty consists of a 2-year unlimited-mileage warranty and a third-year warranty with a 60,000-mile limitation. 4-year warranty consists of a 2-year unlimited-mileage warranty and 2 further years' coverage with a 75,000-mile limitation. 5-year warranty consists of a 2-year unlimited-mileage warranty and 3 further years' coverage with a 90,000-mile limitation.

<sup>^</sup>Only available before registration of your Audi A1. Please speak to your Audi Centre for full details.

<sup>†</sup>Total RRP inc VAT – Recommended Retail Price including VAT which is calculated at 20%. This may alter to reflect any change in the applicable VAT rate.

– = Not available • = Available S = Standard



# Audi configurator

## The easy way to build your Audi

Our online configurator makes it easy to create and price your ideal Audi by simply choosing your favourite options.

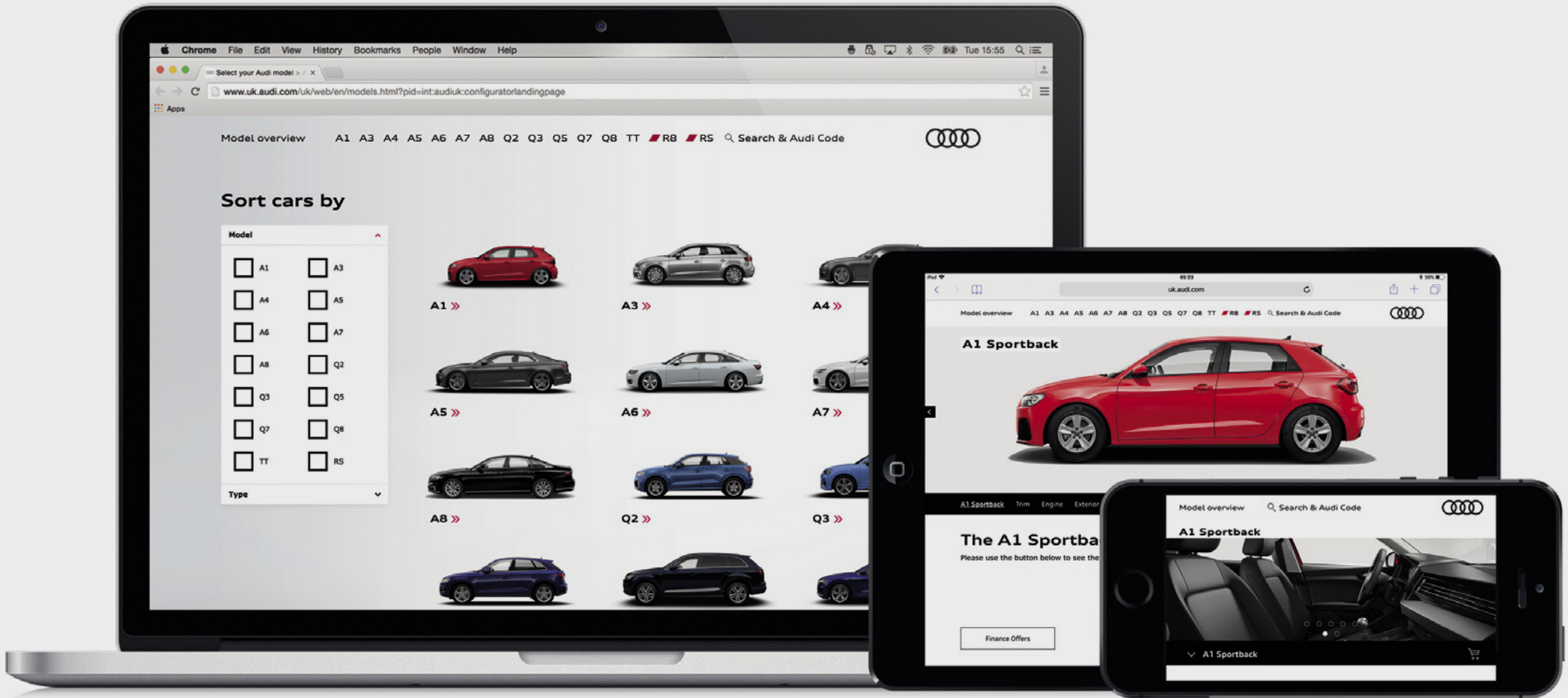

Visit [www.audi.co.uk/configurator](http://www.audi.co.uk/configurator) to create your perfect Audi A1 Sportback

# Financing your Audi

## A range of finance plans designed to suit you

At Audi, we offer a range of ways to finance your new Audi – with most finance agreements, you just need to choose your annual mileage and the length of the term, then pay an initial deposit which could be as little as 1 monthly payment.\* For more details, visit [www.audi.co.uk/finance](http://www.audi.co.uk/finance) or speak to your local Audi Centre.

### Solutions Personal Contract Plan

A flexible finance plan designed to give you a number of options, making it ideal if you want to change your car more regularly. At the end of the agreement, you have 3 choices:

1. Exchange the car for a new Audi.
2. Pay the option to purchase fee and optional final payment, then take full ownership of the car.
3. Simply return the car to Audi (fees may be payable).

### Hire Purchase

If you know you'd like to keep your Audi, Hire Purchase could be right for you. And as you're making your payments with a view to owning the car, there's no restriction on how many miles you can drive each year.

### Contract Hire

If you don't want to own your Audi, Contract Hire could be a great option. You can add a service, maintenance and tyres plan and, for VAT-registered businesses, an element of the VAT on rentals may be recoverable.† Once you have selected your Audi, all you need to do is choose how long you want to hire it for and your annual mileage per year. With Contract Hire, you pay an initial rental payment followed by monthly rental payments during your agreement. Once your agreement ends, you simply hand the car back (subject to fair wear and tear and excess mileage charges).

### Online Finance Calculators

Use our online Finance Calculator to get a personalised quote that suits you. Simply visit the Finance and Offers section on [www.audi.co.uk](http://www.audi.co.uk) and you can choose between our Solutions Personal Contract Plan and Contract Hire calculators and see what you can expect to pay for your new Audi.

### Buy my Audi

Visit Buy my Audi, [bma.audi.co.uk](http://bma.audi.co.uk), where you can easily search for new Audis within your budget, reserve and apply for finance, all in 1 place.

### Audi Insurance

Start enjoying your new car from day 1 with our complimentary 5-day insurance. Call us on 0345 877 6236, give us a few details, and you can drive away as soon as you take delivery of your new Audi. If you are eligible, we will also provide you with an annual quotation giving you the option to purchase 12 months of cover.

Audi Car Insurance includes many features and benefits as standard, including a guarantee that your vehicle will be repaired by Audi Trained Technicians, in Audi Approved Repairers, using only Audi Genuine Parts. For an annual insurance quote call 0345 246 4030.

Telephone lines are open Monday to Friday 8am-8pm and Saturday 9am-5pm. For details of our full range of insurance products, visit [www.insurewithaudi.co.uk](http://www.insurewithaudi.co.uk)

\*An offer of finance depends on certain conditions. Finance subject to status. Available to 18s and over. Terms and conditions apply. Audi Financial Services.

†This is subject to a 50% block where there is any element to private use of a motor car. The above note is intended as a summary of the principles of VAT and tax in this complex area. It is not intended to be and should not be construed as constituting tax advice and we make no representations, warranties or guarantees, whether express or implied, that the content is accurate, complete or up-to-date. Volkswagen Financial Services (UK) Limited cannot be held liable in any way for any reliance upon this document, whether in contract, tort (including negligence), breach of statutory duty, or otherwise, even if foreseeable. For specific tax advice relating to your particular set of circumstances, you should contact your own HMRC officer or your usual VAT/tax advisers.

^Subject to eligibility. Audi Car Insurance is underwritten by U K Insurance Limited, Registered Office: The Wharf, Neville Street, Leeds LS1 4AZ. Registered in England and Wales No. 1179980. U K Insurance Limited is authorised by the Prudential Regulation Authority and regulated by the Financial Conduct Authority (FCA) and the Prudential Regulation Authority. Calls may be recorded. Audi Financial Services is a trading name of Volkswagen Financial Services (UK) Limited (VWFS UK), registered in England and Wales No. 2835230 (registered office: Brunswick Court, Yeomans Drive, Blakelands, Milton Keynes MK14 5LR). Volkswagen Insurance Service (Great Britain) Ltd is an appointed representative of VWFS UK. VWFS UK is authorised and regulated by the FCA, registration number 311988. Authorisation details for both organisations can be checked on the Financial Services Register by visiting [www.fca.org.uk](http://www.fca.org.uk) VWFS UK and U K Insurance Limited are not part of the same corporate group.

# A1 Sportback technical data

	Petrol engines				
Engine	30 TFSI	30 TFSI	35 TFSI	35 TFSI	40 TFSI
Transmission	6-speed manual	7-speed S tronic	6-speed manual	7-speed S tronic	6-speed S tronic
Cylinder	3-cylinder	3-cylinder	4-cylinder	4-cylinder	4-cylinder
Displacement, cubic cm	999	999	1498	1498	1984
Max. power, <sup>1</sup> PS at rpm	116/5000–5500	116/5000–5500	150/5000–6000	150/5000–6000	200/4400–6000
<b>Performance</b>					
Max. torque, Nm at rpm	200/2000–3500	200/2000–3500	250/1500–3500	250/1500–3500	320/1500–4400
0–62mph acceleration, seconds	9.5	9.4	7.7	7.7	6.5
Top speed, mph	126	126	137	137	146
<b>Weight</b>					
Unladen weight, <sup>2</sup> kg	1105	1125	1150	1165	1260
Gross weight limit, kg	1655	1680	1690	1705	1775
<b>Further information</b>					
Roof load limit/nose weight, kg	75/-	75/-	75/-	75/-	75/-
Fuel tank approx. capacity, litres	40	40	40	40	40
ABI insurance group 1–50 <sup>4</sup>	20E	20E	26E	26E	31E

<sup>1</sup>The given value was obtained in accordance with the specified measurement procedure (the respective current version of the Directive 80/1269/EEC). The maximum power output figures are quoted in PS (or Pferdestärke, which is the metric equivalent of brake horsepower). To convert to brake horsepower, divide the PS figure by 1.0139. <sup>2</sup>Vehicle's unladen weight without driver (calculated in accordance with the current version of Directive (80/1268/EEC)). The fitting of additional equipment may increase the vehicle's unladen weight and drag coefficient, whereupon the potential carrying capacity and top speed will be correspondingly reduced. <sup>3</sup>The engine's power output always goes down with increasing altitude. At 1,000m above sea level, and for every additional 1,000m, deduct 10% from the weight of the outfit (trailer load limit + gross weight of the towing vehicle). <sup>4</sup>Highest insurance group rating shown. Group may be lower dependent on trim level. Please visit [www.thatcham.org/abigrouprating](http://www.thatcham.org/abigrouprating) for details.

# A1 Sportback technical data continued

The CO<sub>2</sub> data below is NEDC equivalent data from WLTP testing and will be used for taxation purposes for your vehicle. Depending on your chosen Audi A1 model or wheel size, different efficiency figures for CO<sub>2</sub> emissions will apply. This table is a quick reference guide to assist you in finding the correct values based on wheel sizes and your chosen engine. The fuel consumption data shown is the combined data from WLTP testing cycles. Under WLTP testing all options can affect consumption values, therefore, the data shown reflects the range of consumption data for the relevant model; due to the impact options can have on the consumption of the vehicle.

		Petrol engines				
Engine		30 TFSI	30 TFSI	35 TFSI	35 TFSI	40 TFSI
Transmission		6-speed manual	7-speed S tronic	6-speed manual	7-speed S tronic	6-speed S tronic
Max. power, <sup>1</sup> PS at rpm		116/5000–5500	116/5000–5500	150/5000–6000	150/5000–6000	200/4400–6000
Wheel and Tyre Clustering						
NEDC equivalent CO <sub>2</sub> emissions, <sup>2</sup> g/km	15" alloy	108	108	-	-	-
	16" alloy	111	110	119	115	-
	17" alloy	111	110	119	115	136
	18" alloy	111	111	120	116	137
Benefit in kind 2018/19 tax year (BIK)%	15" alloy	22%	22%	-	-	-
	16" alloy	23%	23%	24%	24%	-
	17" alloy	23%	23%	24%	24%	28%
	18" alloy	23%	23%	25%	25%	28%
WLTP Fuel consumption, <sup>2</sup> mpg (l/100km) Combined	SE	48.7 (5.8) – 52.3 (5.4)	45.6 (6.2) – 47.9 (5.9)	-	-	-
	Sport	48.7 (5.8) – 50.4 (5.6)	45.6 (6.2) – 47.1 (6.0)	44.8 (6.3) – 46.3 (6.1)	43.5 (6.5) – 44.8 (6.3)	-
	S line	48.7 (5.8) – 49.6 (5.7)	45.6 (6.2) – 46.3 (6.1)	44.8 (6.3) – 45.6 (6.2)	43.5 (6.5) – 44.1 (6.4)	-
	S line Competition	-	-	-	-	39.8 (7.1) – 40.4 (7.0)
	S line Style Edition	-	-	44.8 (6.3) – 45.6 (6.2)	43.5 (6.5) – 44.1 (6.4)	-
	S line Launch Edition	-	-	44.8 (6.3) – 45.6 (6.2)	43.5 (6.5)	-

<sup>1</sup>The given value was obtained in accordance with the specified measurement procedure (the respective current version of the Directive 80/1269/EEC). The maximum power output figures are quoted in PS (or Pferdestärke, which is the metric equivalent of brake horsepower). To convert to brake horsepower, divide the PS figure by 1.0139. <sup>2</sup>Figures shown are for comparability purposes; only compare fuel consumption and CO<sub>2</sub> figures with other vehicles tested to the same technical procedures. These figures may not reflect real life driving results, which will depend upon a number of factors including the accessories fitted (post-registration), variations in weather, driving styles and vehicle load. There is a new test used for fuel consumption and CO<sub>2</sub> figures (known as WLTP). The CO<sub>2</sub> figures shown however, are based on a calculation designed to be equivalent to the outgoing (NEDC) test cycle and will be used to calculate vehicle tax on first registration. For more information, please see [audi.co.uk/wltp](http://audi.co.uk/wltp) or consult your Audi Centre. Data correct at time of publication. Figures quoted are for new factory orders only and a range of configurations, and are subject to change due to ongoing approvals/changes. Please consult your Audi Centre for further information or the exact specification and technical data for your model.

# A1 dimensions

## All the measurements you need

See the exact dimensions of the Audi A1, so you can check everything – from whether the car fits your garage to whether your luggage fits the boot.

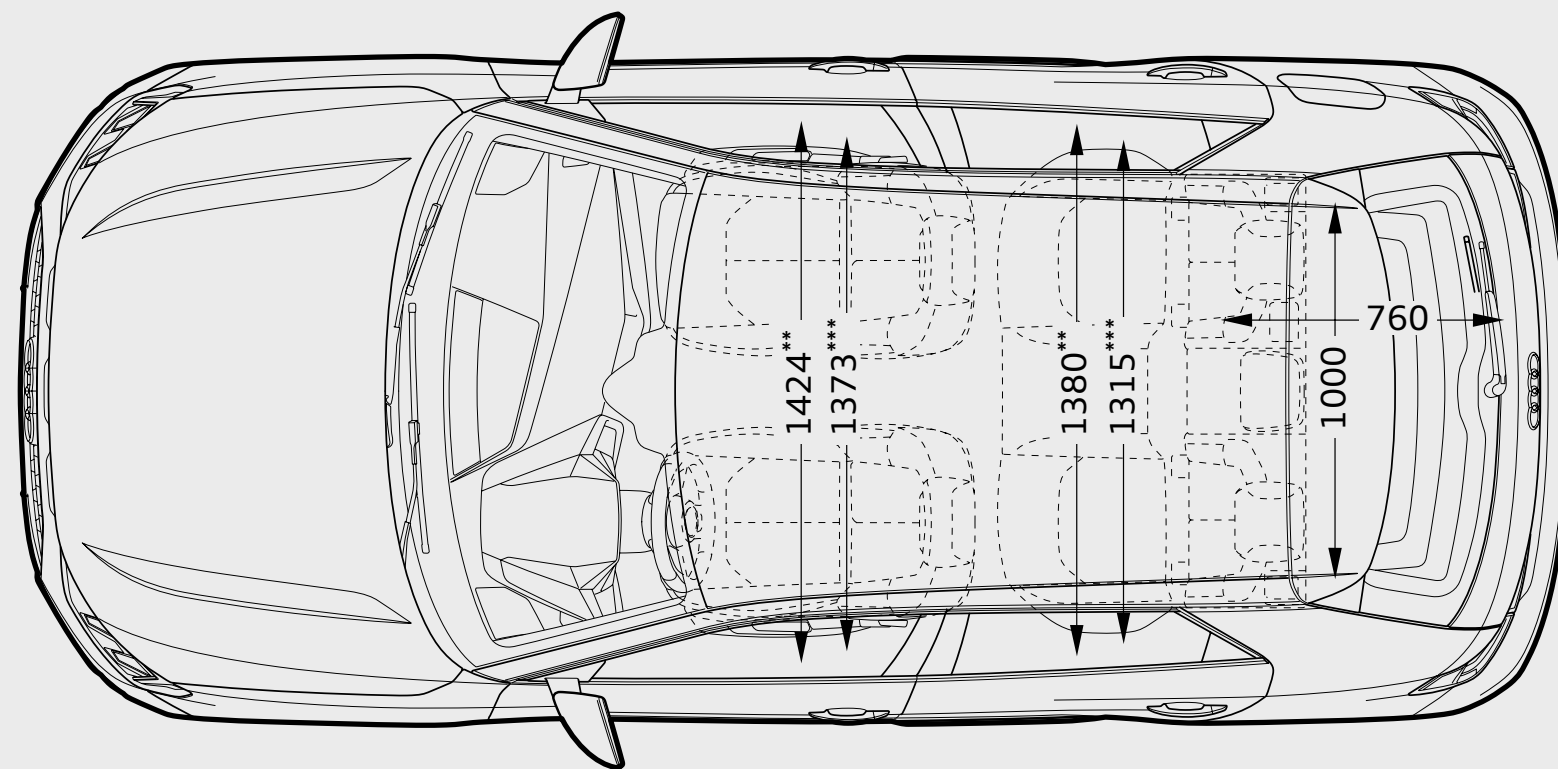
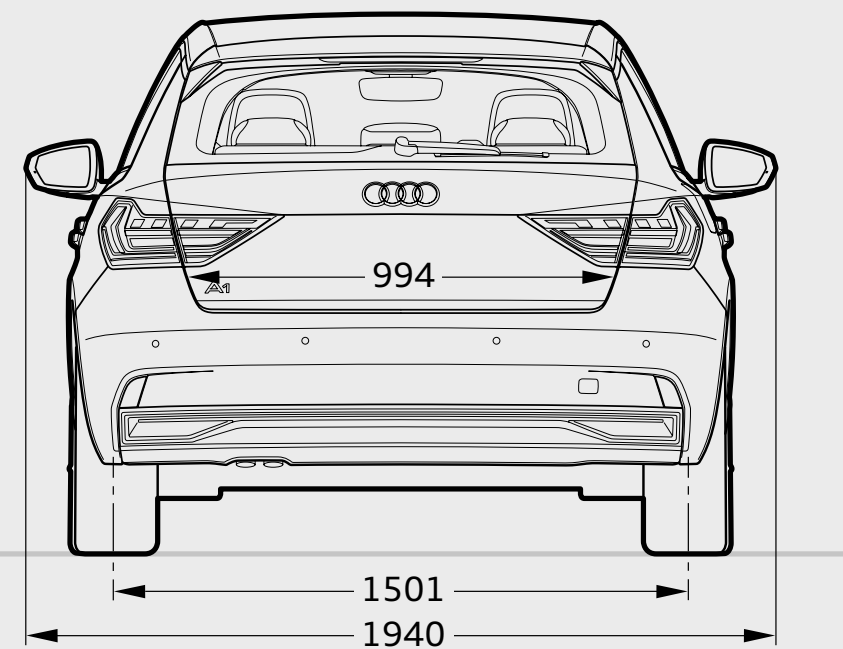
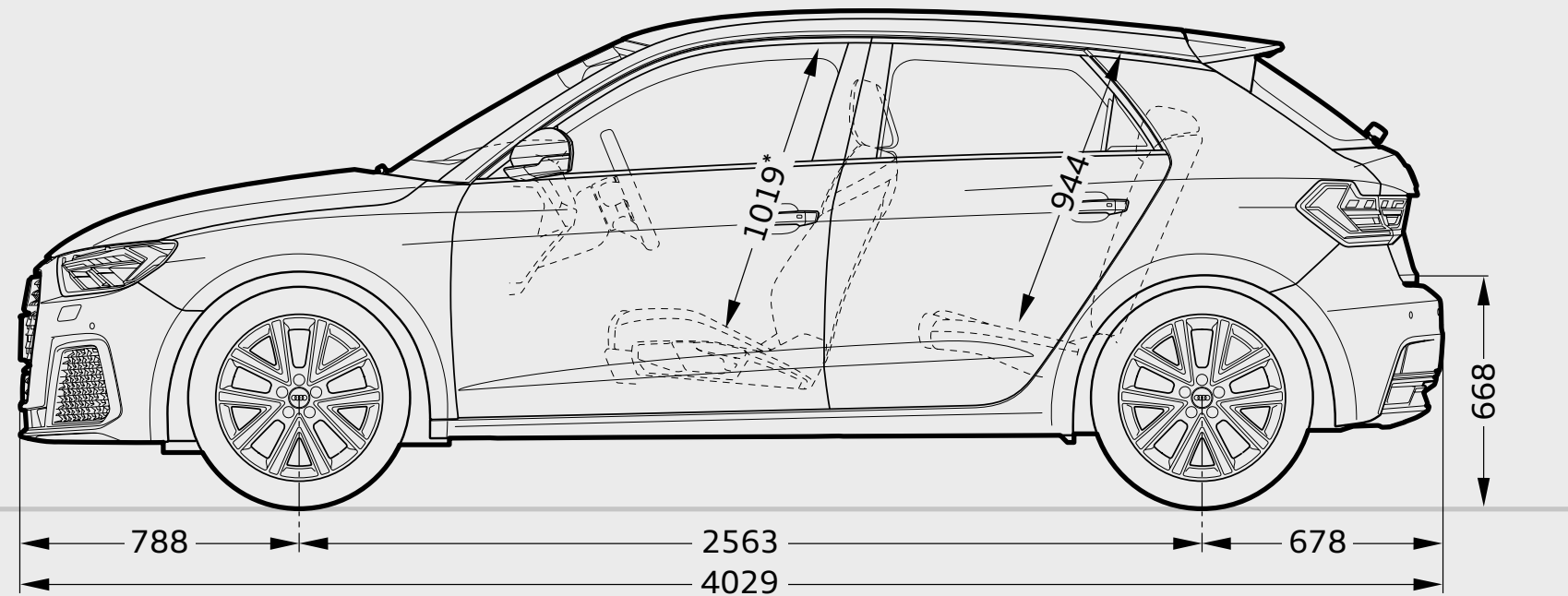
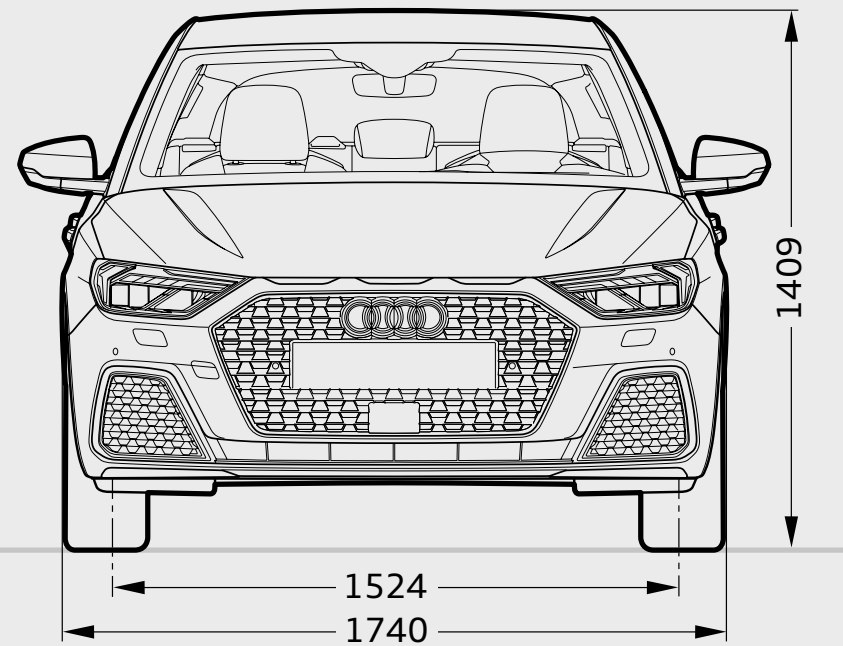

Dimensions in millimetres. Optional equipment may affect dimensions.  
 Dimensions were measured with vehicle at unladen weight. Turning circle approx. 10.5m.  
 \*Maximum headroom. \*\*Elbow room width. \*\*\*Shoulder room width.  
 †Measured by the VDA standard test method using 200 x 100 x 50mm blocks.

A1 model luggage compartment capacity:†  
 335l (rear seats up) or 1,090l (rear seats folded down).

# Important information

## Welcome to Audi

### Audi customer care

Every new Audi includes these reassuring features as standard:

- ▶ 3-year Audi warranty (unlimited mileage in the first 2 years, with a full mechanical and electrical warranty up to 60,000 miles in the third year)
- ▶ A 3-year paint warranty
- ▶ A 12-year anti-corrosion warranty
- ▶ 3-year UK roadside assistance and recovery
- ▶ 3-year accessories warranty on any accessories purchased with your car (2-year warranty if purchased separately from your new Audi)\*

You also have the option when ordering your new car of choosing a 4-year or 5-year Audi warranty. Speak to a member of the sales team for more information.

Warranty terms and conditions apply. Please see [www.audi.co.uk/warrantyterms](http://www.audi.co.uk/warrantyterms) for further details.

### Information in this pricelist

We've done all we can to make the prices, specifications, technical details and all other information you see in this pricelist accurate at the time of publication. However, as our products are constantly being updated, we recommend checking the details with your Audi Centre.

We reserve the right to change prices or specification at any time. All prices shown in this guide include VAT which is currently charged at 20%.

Delivery charges and number plates are not included in the Total RRP inc VAT vehicle price.

Delivery charge	£504.99
Number plate	£20.00
VAT	£105.01
Total	£630.00

Recommended On-The-Road (OTR) prices include the delivery and number plate charges above, Road Fund Licence (which may vary depending on model/transmission – see table for details) and first registration fee at £55.00.

The images featured in this pricelist are for illustrative purposes only. They may feature left-hand drive vehicles and include equipment that is not UK specification.

### CO2 emissions-based Vehicle Excise Duty

Vehicle Excise Duty (Road Fund Licence) is based upon the amount of Carbon Dioxide (CO<sub>2</sub>) a vehicle emits, measured in grams per kilometre (g/km). First-year VED rates apply to the first year of ownership. Standard VED rates apply thereafter. The DVLA has created 13 categories:

#### Vehicles registered on or after 1 April 2018

Petrol and Diesel engines	First year rate	First year rate Diesel vehicles <sup>†</sup>	Standard rate <sup>^</sup> (second year onwards)
<b>A – 0g/km</b>	£0	£0	£0
<b>B – 1 to 50g/km</b>	£10	£25	£140
<b>C – 51 to 75g/km</b>	£25	£105	£140
<b>D – 76 to 90g/km</b>	£105	£125	£140
<b>E – 91 to 100g/km</b>	£125	£145	£140
<b>F – 101 to 110g/km</b>	£145	£165	£140
<b>G – 111 to 130g/km</b>	£165	£205	£140
<b>H – 131 to 150g/km</b>	£205	£515	£140
<b>I – 151 to 170g/km</b>	£515	£830	£140
<b>J – 171 to 190g/km</b>	£830	£1,240	£140
<b>K – 191 to 225g/km</b>	£1,240	£1,760	£140
<b>L – 226 to 255g/km</b>	£1,760	£2,070	£140
<b>M – over 255g/km</b>	£2,070	£2,070	£140

Vehicle Excise Duty (VED) rates correct at time of publication, but these may alter to reflect any change in the applicable VED rate.

<sup>†</sup>This rate applies to diesel vehicles that do not meet the real driving emissions step 2 (RDE2) standard.

<sup>^</sup>Vehicles with a list price exceeding £40,000 (including factory installed options, delivery charge, number plates and VAT) will pay an additional £310 plus the standard annual rate for a 5-year period. After the 5-year period only the standard rate will apply.

\*Excludes Road Angel products.

# Important information continued

## Audi tax-free sales

If you are entitled to purchase a vehicle free of VAT, normally through military or diplomatic privilege, please contact your local Audi Centre for full details. Should you have any difficulty obtaining the information you require, please call 0870 241 5663.

## Audi Connect Terms and Conditions

The Audi Connect Online Services (“Connect Services”) are provided by Audi AG, and are included as standard in certain models within the Audi range of vehicles and are also available within some optional packs, such as the Audi Technology Pack. Audi AG is a company within our corporate group.

The Connect Services include:

- ▶ Audi Connect Infotainment Services (“Infotainment Services”); and
- ▶ Audi Connect ‘Safety and Service’ Services (comprising myService and myCarManager) (“Safety and Service”).

Some services require additional activation steps. In order to enjoy these services customers must register, accept the terms and conditions and follow the activation steps instructed on myAudi (please visit <https://login.audi.com>).

Some services also require the download of the myAudi app on a compatible phone or tablet (always check latest phone and software compatibility).

Whilst correct at the time of publication, the content and scope of the Connect Services offered may vary from time to time. Features vary by model. Audi AG may add, change, replace or remove individual services or features at any time during your subscription for the Connect Services.

Enhancements in vehicle technology, information technology and web-based services sometimes require the Connect Services to be adapted and enhanced in line with new forms of technology or changes in user behaviour. In this context, Audi AG reserves the right at any time to enhance, reduce or change the functional scope of the Connect Services in a manner that it considers is reasonable for the customer.

For full details of the specific Connect Services on your vehicle, together with complete and up-to-date terms and conditions for those Connect Services, please visit [www.audi.co.uk/connectterms](http://www.audi.co.uk/connectterms)

## Audi Connect Infotainment Services

Audi Connect Online Infotainment Services (“Infotainment Services”) are provided via a SIM card embedded in the vehicle.

The Infotainment Services enable access to certain search, social media and other online services provided by third parties. Features vary by model. Permanent availability cannot be guaranteed as this is the responsibility of the relevant third party provider.

Infotainment Services are available only within the range of the selected mobile phone network operated by Audi AG’s chosen mobile phone provider (which may change from time to time) and where there is mobile reception, including an active data connection.

Data is unlimited. There are no additional charges for data roaming within the EU (although availability of these services is limited to certain countries). You will not, however, be able to use the embedded SIM to provide Wi-Fi hotspot services or to tether any other device to the embedded SIM. Should you wish to create a Wi-Fi hotspot we recommend you purchase Wi-Fi data packs via myAudi (link: <https://login.audi.com>). Any Wi-Fi data packs purchased via myAudi will remain with the vehicle upon sale of the vehicle and no refunds will be provided.

If you insert an external SIM card into the card slot (e.g. so as to enable Wi-Fi hotspot services), then all Infotainment Services data connections will be made via this SIM card (and not the Audi embedded SIM card) and all related data costs incurred may be charged to the customer by the provider of the plan associated with the external SIM card.

You may not use the Connect Services and the embedded SIM for any purpose other than the provision or receipt of services in accordance with these terms.

For vehicles which have hazard alert and traffic sign information features, the vehicle sensors will be transmitting information to Audi AG. This information includes, but is not limited to, vehicle location, speed signs, areas where a risk of skidding, breakdown, accident and/or reduced visibility has been identified. The data is transmitted to Audi AG and shared with other Audi vehicles with hazard alert and traffic sign information features. The data is transmitted anonymously and does not identify an individual vehicle. Such data is only held for the purpose of warning drivers of potential road hazards and change of speed signs.

The subscription is activated from the point of vehicle registration. Should you wish to continue to use the Connect Services after your subscription expires, please consult your local Audi Centre for details (including the latest subscription fees). Charges will apply upon renewal.

# Important information continued

## Audi Connect Safety and Service

Audi Connect Online Safety and Service (“Safety and Service”) is available on certain models and is provided via a SIM card embedded in the vehicle.

Safety and Service features are available only within the range of the selected mobile phone network operated by Audi AG’s chosen mobile phone provider (which may change from time to time) and where there is mobile reception, including an active data connection.

You may not use the Connect Services and the embedded SIM for any purpose other than the provision or receipt of services in accordance with these terms.

Safety and Service comprises:

- 1) myService; and
- 2) myCarManager.

For full details of the features of Safety and Service, please visit [www.audi.co.uk/connectterms](http://www.audi.co.uk/connectterms)

## MMI Navigation Plus – online map updates and myAudi Special Destinations

The map version delivered with vehicles with MMI Navigation Plus can be updated free of charge for the first 5 updates after vehicle delivery (which are generally issued at intervals of 6 months). The current navigation data can be downloaded from the myAudi platform at [www.audi.com/myaudi](http://www.audi.com/myaudi) and embedded in the vehicle via SD card. In conjunction with Audi Connect Infotainment Services, the update can be carried out online in the vehicle (subject to mobile reception and an active data connection). For further navigation updates, it is possible to purchase new navigation data maps from your local Audi Centre at extra cost – please contact them for details.

With myAudi Special Destinations, you can download your favourite POI lists available on the internet (such as favourite restaurants) and have these displayed on your navigation map. In order to enjoy this service, customers must register, accept the terms and conditions and follow the instructions given on myAudi. Please visit <https://login.audi.com/login>

## Diamond-cut finish alloy wheel

Diamond cut is a special finish on aluminium wheels. It is also sometimes referred to as ‘polished’ or ‘partly polished’. Special aftercare should be taken when driving in extreme wintry road conditions.

For manufacturing reasons, these wheel surfaces do not have sufficient corrosion protection for such use and they can be permanently damaged by road salt or similar.



# Audi Vorsprung durch Technik

**Audi UK**  
Customer Services  
Selectapost 29  
Sheffield  
S97 3FG  
0800 699 888  
[www.audi.co.uk](http://www.audi.co.uk)

Information in this guide is  
subject to change without notice.

© Audi (UK)  
A1 Sportback Pricelist.  
Edition 2 01/19  
2019 Model Year

Images are for illustrative purposes only.