



MAXUS

MAXUS
DELIVER 9



MAXUS DELIVER 9 RANGE

THE PURE DRIVING EXPERIENCE



MANUFACTURER

Innovative, thought-leading, and future-focused. Shanghai Automotive Industry Corporation (SAIC) is the largest automotive group in China, and is the name behind the MAXUS (formerly LDV) brand.

Based in Shanghai, SAIC produces almost seven million vehicles each year for both domestic and international markets and is a Fortune Global 500 listed company with almost 100,000 employees.

With a long history tracing back to the 1940s, SAIC saw real growth from the mid-1980s onwards following a number of partnerships that allowed it to produce competitive vehicles by utilising the latest technology.

The company has a number of well-known brands within its portfolio including, since 2010, the acclaimed MAXUS range of LCVs. SAIC has invested more than €2billion in this brand, with a strong focus on safety, innovation and the introduction of new products to the range, including a suite of EVs that are already setting the standard for the future of eco-fuelled commercial motoring.

Since acquiring LDV, these LCVs were manufactured under the MAXUS moniker for the home market in China in addition to selected left hand drive markets in Europe such as Spain, Belgium and The Netherlands. In April 2020, LDV rebranded as MAXUS across right hand drive Europe, coinciding with the launch of the all-new DELIVER 9 and the newest EV in the brand's stable, the eDELIVER 3, thereby consolidating the brand's presence across Europe, China and beyond.

With an even brighter future ahead, SAIC's key areas of development are electrification, car sharing, connectivity and globalisation. Today, there are eight major automotive groups within SAIC, including SAIC MAXUS.

SAIC's vision is to continue to build an innovative, globally-recognised company that pioneers the future of the automotive industry, actively promoting new energy vehicles.

DISTRIBUTOR

You are the expert in your field but when it comes to automotive expertise, The Harris Group is here to guide you through your search for the right vehicle for your business. One of the longest-established automotive distribution and assembly companies in Ireland and the UK, The Harris Group was founded in 1961 and is an industry leader in the commercial and fleet sectors.

The privately-owned company is best known for its commercial vehicle brands that include Hino, Sinotruk, Higer, Isuzu, AOS and Crusader. In 2016, The Harris Group acquired the distribution rights to MAXUS (formerly LDV) across right hand drive Europe and the range of LCVs, which includes market-leading electric vehicles, has taken the market by storm.

The Harris Group has developed an unrivalled reputation for service excellence in the UK and Ireland, which comes from almost 60 years of experience. Harris is the distributor for the MAXUS range of vehicles in the UK, Ireland, Channel Islands, Isle of Man, Malta and Cyprus.



OUR NETWORK

With a strong dealer network of dedicated and experienced commercial vehicle specialists, we offer the highest standards of expertise whether you are looking to buy one van or an entire fleet.

Following a high-profile relaunch of the LDV brand in 2016, Harris is continuing to build its network across all right hand drive markets in Europe.

Today, the Group represents the MAXUS range in a total of seven territories, including the UK, Ireland, Channel Islands, Isle of Man, Malta and Cyprus, with the company focussed on a big drive to expand the dealer network throughout the UK.

Every dealer within the company's network operates with a strong focus on after-sales activities, thereby ensuring complete customer satisfaction.

Check out www.saicmaxus.co.uk to find your local dealer.



HIGH EFFICIENCY AND LOW CONSUMPTION

- New Euro 6d Engine – D20
- 163 PS @ 4000
- 375Nm
- WLTP compliant
- Advanced ECO-Technology
- DPF warning indicator with Manual Regen function button
- Quieter NVH Solution

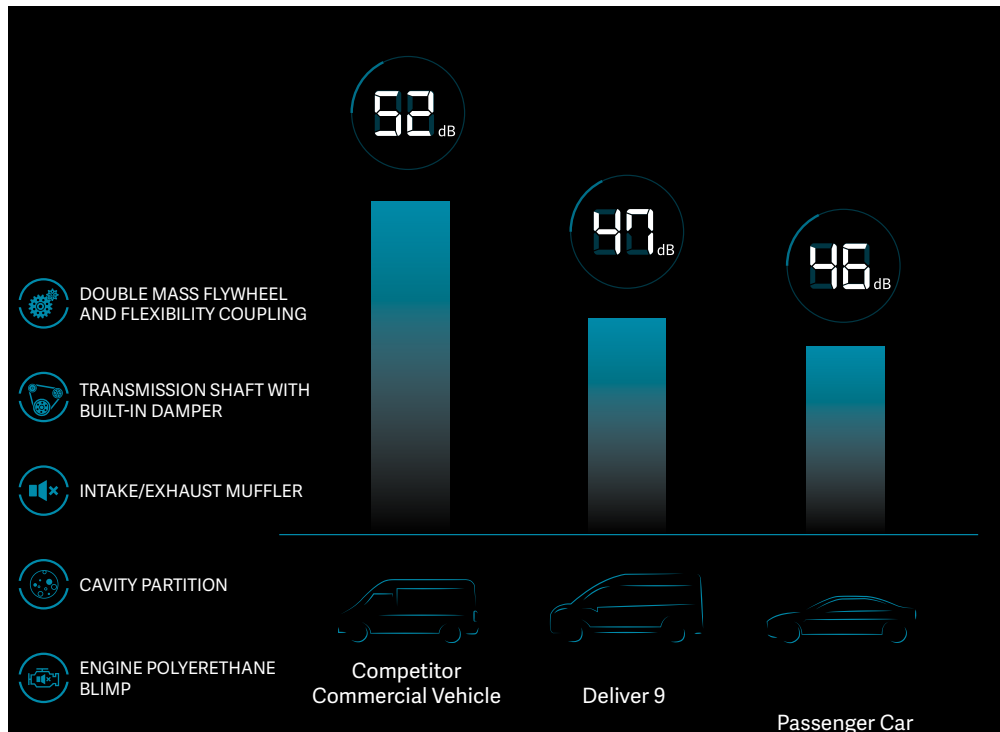

MAXUS DELIVER 9 offers the pure driving experience. Ask yourself, what's essential to you or your drivers' needs as they go about their daily business? If the answer is outstanding performance, high efficiency and superb reliability, no matter what the weather conditions, you've found your perfect match.



1. 2000 bar High Pressure Fuel System



2. Variable Swirl Valve



3. VGT Turbo Charger



4. HP-LP EGR Models



5. Water-Air Cooler



6. Split Cooling System



7. Off-Set Crankshaft



8. Two-Stage Variable Displacement Oil Pump

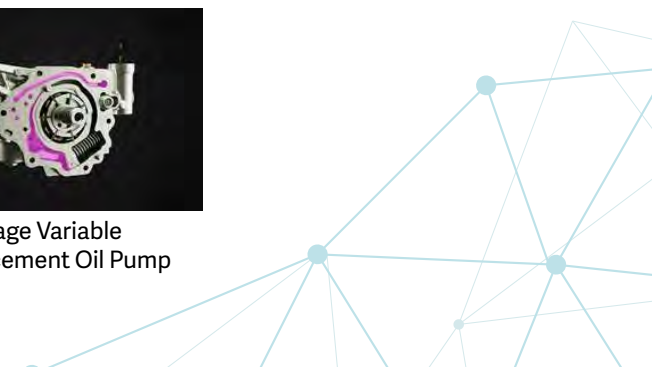



12:51 AM 4G LTE Local Station - FM 87.5

Local Station

FM 87.5
Broadcasting Station

AM K || K

RES+ SET- OK SRC

Door Open

1 2 3 4 5
2 4 6



AIRBAG

STORAGE SYSTEM

The new MAXUS DELIVER 9 offers all the storage you need to keep your space neat, organised and completely manageable as you go about your working day. There really is a place for everything. In addition to your glove box and a large deep storage space in the doors for water bottles, there are plenty of extra spaces that you won't even know you needed until now. You'll find storage space under the bench seating in the vehicle as well as a practical foldable seatback with two cup holders and a tablet holder. The dashboard includes cup holder storage along with a selection of other storage options above the glove box and windscreen visor.

- USB port and mini jack port¹ (driver and passenger)
- Storage space under the bench seat
- Foldable seat back with cup holders and tablet holder
- Storage compartments in the doors
- Cup holder (driver and passenger)
- 12 V power socket
- Overhead storage on medium and high roof vans
- Sophisticated storage system with compartments
- Deep door water storage holders



Under Seat Storage



Laptop and Cup Holder Rest



Glove Box Storage



Large Side Door Storage



The Infotainment System takes the MAXUS DELIVER 9 driving experience from ordinary to extraordinary

Both the MAXUS DELIVER 9 and DELIVER 9 Luxury Model offer a pure driving experience that any van driver will appreciate. Professional drivers have busy and often long days, and this is why the DELIVER 9 cabin area offers all the comfort and practicality of a mobile office space.

Packed with cutting-edge technology and practical features, you'll have everything you need and all operated at the touch of a button on a 10 inch touch screen. In addition to radio and navigation functions, the high spec includes USB ports for both the driver and passenger, so you can always

remain connected whether by laptop or by simply hooking up your smartphone to the system. A ready-to-go mobile office space. Use mirror link to access all your apps and emails, apple carplay™ and android auto adaptable.*

* * Touch screen with mirror link optional – Standard on Lux model

MULTI-FUNCTION STEERING WHEEL

CRUISE CONTROL SPEED LIMITER

Cruise Control allows you to set the cruising speed and keep it constant. The Speed Limiter allows you to set the maximum speed that the vehicle can reach, increasing safety and reducing the risk of violations. When the accelerator pedal is fully depressed, the driver can exceed the limit set for specific overtaking manoeuvres.

MAXIMUM COMFORT, MAXIMUM CONTROL

For the professional driver, we know how important a relaxed, comfortable space is as you go about your business. In the MAXUS DELIVER 9, comfort is paramount.

With our ever-changing climate, the importance of a good air conditioning system was always going to be a factor when it came to designing this vehicle. The DELIVER 9 models include manual air conditioning for your comfort and the comfort of your passengers. The variable control of the air conditioning system ensures that the temperature can be adjusted to the desired level easily and quickly. So you can always rely on a pleasant work environment, whatever the weather.

The DELIVER 9 gives ease of all controls at hand like cell phone, cruise control, speed and audio.



DRIVERS' ENVIRONMENT

COMFORT AND SAFETY

The DELIVER 9 offers eight adjustable driver seat options ranging from standard to comfort, with added lumbar support and armrest. Seating covers are built for comfort and durability and come in knit/grey heavy duty, hard-wearing fabric.

SIX AIR BAGS

Occupant safety is paramount in the DELIVER 9 with six airbags as standard, side & window curtain airbags in addition to driver and passenger front airbags.



Reverse parking sensors are standard fitment on Delivery 9. Optional high mounted reversing camera with on screen guidelines in addition to front and rear parking sensors increase visibility and ensure safer parking (standard on Lux Model).



HUB CAPS AND RIMS

Steel centre caps on the standard DELIVER 9 and alloys on the luxury DELIVER 9 model.





COMPREHENSIVE SAFETY AS STANDARD

At MAXUS, safety is paramount and the DELIVER 9 meets all European commercial vehicle collision design standards.

Advanced driver assistance system as standard with the latest generation of Bosch 9.3ESP Electronic Stability Program and delivers comfort and peace of mind in any situation.

LCA Lane Change Assist + BSD Blind spot detection gives the driver the extra eyes when on route.

TRACTION CONTROL
TCS (traction control system) has been deactivated.

START/STOP WARNING
Informs the driver that Intelligent Stop / Start system is active and the engine has been shut down.

LANE DEPARTURE WARNING
Vehicle is detected to be moving out of its current lane with out signalling.

AUTOMATIC EMERGENCY BRAKING (AEB)
AEB system is turned off or when the radar sensor or cover is blocked with dirt or snow. Light means it has been deactivated.

ECO DRIVING INDICATOR
Eco function is activated.

PWR DRIVING INDICATOR
Power mode function is activated.

LANE CHANGE ASSIST BLIND SPOT DETECTION
Turns on when the lane assist system is switched on and road markings can be detected.

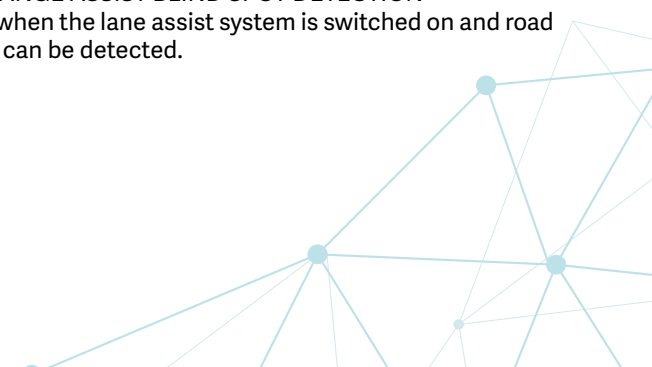



MAXUS Signature lense

8 Loading Eyes

236° Opening Angle

LED Signature Parking Lamp

Counter Sunk Lashing Rings

Non Slip Flooring

Rear Parking Sensors

Low Loading Step



LOADING COMPARTMENT

The DELIVER 9 offers a practical and efficient load area. Features include a heavy-duty steel bulkhead and rear doors that can be opened to 260° for ease of loading with a forklift, while the low rear step makes it easier to load cumbersome items. Eight heavy duty lashing rings help to secure heavy loads. Grab handles are ideally placed to assist when loading and unloading from the wide rear and side loading doors, and there's even an LED illuminated load compartment, which is great for those dark nights.





MAXUS

THE PURE DRIVING EXPERIENCE





DELIVER 9 MODEL

Standard Equipment

- 236° Opening Angle (with Limited Gemel)
- 8-direction Adjustable Driver's Seat with armrest
- Adjustable non-Pretightening Belt
- Air conditioning
- Auto Latch (12mp/h)
- Automatic Emergency Braking System
- Automatic Off Headlights
- B Column Full Steel Unglazed Partition
- Central Lock
- Cruise Control System
- Driver and Passenger Safety Belt Buckle Reminder
- Driver Seat Airbags + Adjustable non-Pretightening Belt
- Dual Cargo light
- Electric Front Windows
- Electric Power Steering
- ESP+EBA+BAS+HHC

- Foldable Remote Control Key (1 Piece)
- Front Body-Colour Bumper
- Front Double Curtain Airbag
- Front Passenger Airbags
- FWD - Independent McPherson Strut Front Suspension
- RWD - Independent McPherson Strut Front Suspension
- FWD - Solid Axle Hodgkiss Dependant Suspension
- RWD - Drive Axle Leaf Spring
- Halogen Headlight
- Halogen Rear Lamp
- Ignition-off Auto Unlock
- Intelligent Anti-theft Security System
- Lane Departure Warning System
- LED Daytime Running Lights
- Manual DPF Regeneration button
- Outside Rearview Mirror (Natural Colour) Electric
- Multifunction steering wheel

- Natural Colour Handles
- Parking Sensor (Rear Only)
- Passenger Adjustable non-Pretightening Belt
- Radio+MP3+AUX+USB+Bluetooth
- Rear Bumper Nature Colour
- Seat Fabric (Knit/Gray)
- Single-Side Sliding Door
- Smoker Pack
- Tie down points (8)
- Wear Resistant Floor
- Wheel Type (Steel with centre trim)
- Driving Model (Power/Normal/Eco)
- eCall
- Engine Start/Stop
- Rear Fog Lamp

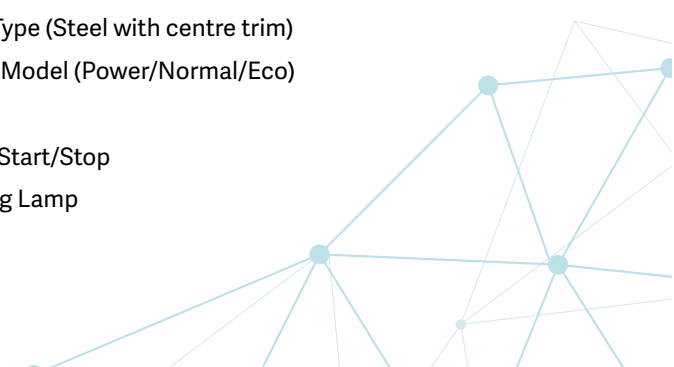



DELIVER 9 LUXURY MODEL

Additional equipment in DELIVER 9 Luxury Model

- + 10 Inch Touch Screen
- + 16" Alloy Wheels
- + Adjustable Overspeed Alarm
- + Apple Carplay and Android Auto
- + Blind Area Monitoring System
- + Body Colour Handles
- + Chrome Front MAXUS Hexagonal Signature Grill
- + Electric Side Step (Optional)
- + Electronic Lock Control
- + Infotainment System
- + Lane Change Assist System
- + LED Headlights
- + LED Day Time Running Light
- + No Key Entry and Start System

- + Parking Sensor (front and back)
- + Reverse Camera with Guide Assist
- + Tyre Pressure Monitoring System
- + Visible Reversing Image



DELIVER 9 MODEL

Body Structure

All good things come in all shapes and sizes, the DELIVER 9 Panel van comes in 3 lengths with 4 roof heights. The DELIVER 9 also has 2 Chassis Cab Lengths to cater for a wide range of options.

For further information see the Deliver 9 specifications on pages 20 -21.

STANDARD CHASSIS (MC)

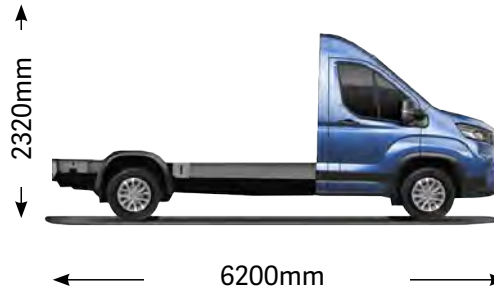

MEDIUM

LONG CHASSIS (LC)

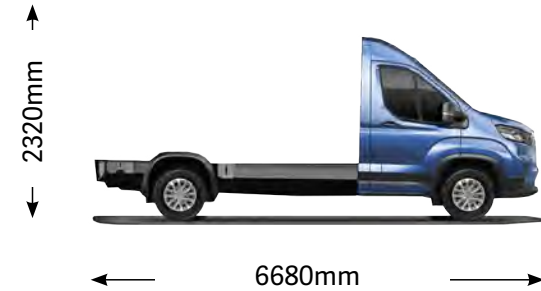

LONG



SHORT / MEDIUM ROOF (SM)



MEDIUM / HIGH ROOF (MH)

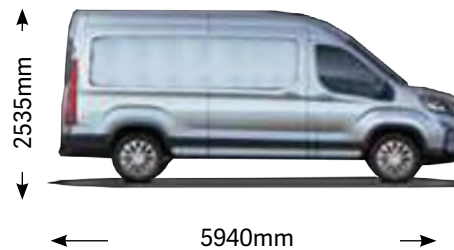

LONG / HIGH ROOF (LH)

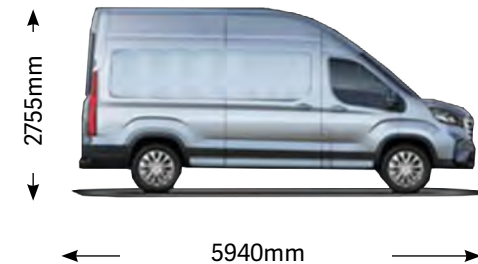

LONG / EXTRA HIGH ROOF (LXH)



Model	DELIVER 9	DELIVER 9 LUX	
Configuration	SAFETY CONFIGURATION		
	Intelligent Anti-theft Security System	Y	Y
	Tyre Pressure Monitoring System	X	Y
	Lane Change Assist System	X	Y
	ESP+EBA+BAS+HHC	Y	Y
	Parking Sensor	Y	X
	Front and Rear Radar	X	Y
	Visible Reversing Image	X	Y
	Driver Seat Airbags	Y	Y
	Front Passenger Airbags	Y	Y
	Passenger Adjustable non-Pretightening Belt	Y	Y
	With eCall	Y	Y
	Automatic Emergency Braking System	Y	Y
	Lane Departure Warning System	Y	Y
	Blind Area Monitoring System	X	Y
	Front Double Curtain Airbag	Y	Y
	EXTERIOR AND INTERIOR		
	Single-Side Sliding Door	Y	Y
	Wheel Type	Steel	Alloys
	B Column Full Steel Unglazed Partition	Y	Y
Non Automatic Front Wiper (No Bone)	Y	X	
Automatic Front Wiper (With Rain Sensor)	X	Y	
Pack Options	TRIM PACK		
	Chrome Plated Radiator Grid	O	S
	Colour Coded Door External Handles	O	S
	Rear Number Plate Top Trim Colour Coded	O	S
	Instrument Panel hi level Chrome/Piano Black Trim	O	S
	Front Door Glass Lift Switch Chrome Plated	O	S
	Alloy Wheels (6.5x16)	O	S
	Front Door Internal Handle Chrome Plated	O	S
	LIGHTING PACK		
	LED Headlights + LED Rear Signature Taillights	O	S
	2 LED Lights Cargo Area	O	S
	Front Fog Lamp	O	S
	SAFETY PACKS		
	Automatic Front Wiper (with rain sensor)	O	S
	Overspeed Alarm	O	S
	Front Proximity Parking Sensor	O	S
	Blind Area Monitoring System + Lane Change Auxiliary System	O	S
	Tire Pressure Monitoring System	O	S

Pack Option	ENTERTAINMENT SYSTEM		
	10-inch Touch Screen (MP5+USB+ Bluetooth +Mobile Phone Mirroring)+4 Speakers (Bass +Treble)+Reverse Camera	O	S
	CONVENIENCE PACK 1		
	Keyless Access and Start System + 2 Smart Keys + Electronic Lock Control	O	S
	CONVENIENCE PACK 2		
Electric Side Step (N/S Sliding Door)	O	O	
COLOUR PACK			
Metallic Paint (Factory Colour Options)	O	O	
Configuration	EXTERIOR AND INTERIOR		
	Halogen Headlight	Y	X
	LED Headlight	X	Y
	Halogen Rear Lamp	Y	X
	With LED Rear Lamp	X	Y
	With Rear Fog Lamp	Y	Y
	With Front Fog Lamp	X	Y
	LED Position Lamp	Y	Y
	COMFORT AND CONVENIENCE		
	With Driving Model (Power/Normal/Eco)	Y	Y
	With Engine Start/Stop	Y	Y
	With PTO Interface(Link with RWD)	Y	Y
	Electric Power Steering	Y	Y
	Electronic Lock Control	X	Y
	Adjustable Over Speed Alarm	X	Y
	Air Conditioning	Y (Front)	Y (Front)
	Cruise Control System	Y	Y
	Electric Heating Outside Rear View Mirror (Natural Color)	X	Y
	Manual Outside Rear View Mirror (Natural Color)	Y	X
	Cigar Lighter	Y	Y
	No Key Entry and Start System	X	Y
	8-direction Adjustable Driver's Seat	Y	Y
	Seat Fabric (Knit/Gray)	Y	Y
	10 Inch Touch	X	Y
	Radio+MP3+AUX+USB+Bluetooth	Y	X
Electric Front Windows	Y	Y	
With Automatic Induction Lamp	Y	Y	
Ignition-off Auto Unlock	Y	Y	
Auto Latch (20km/h)	Y	Y	
Central Lock	Y	Y	
236° Opening Angle (With Limited Gemel)	Y	Y	
Front bumper body-color bumper	Y	Y	
Rear Bumper Natural Color	Y	Y	

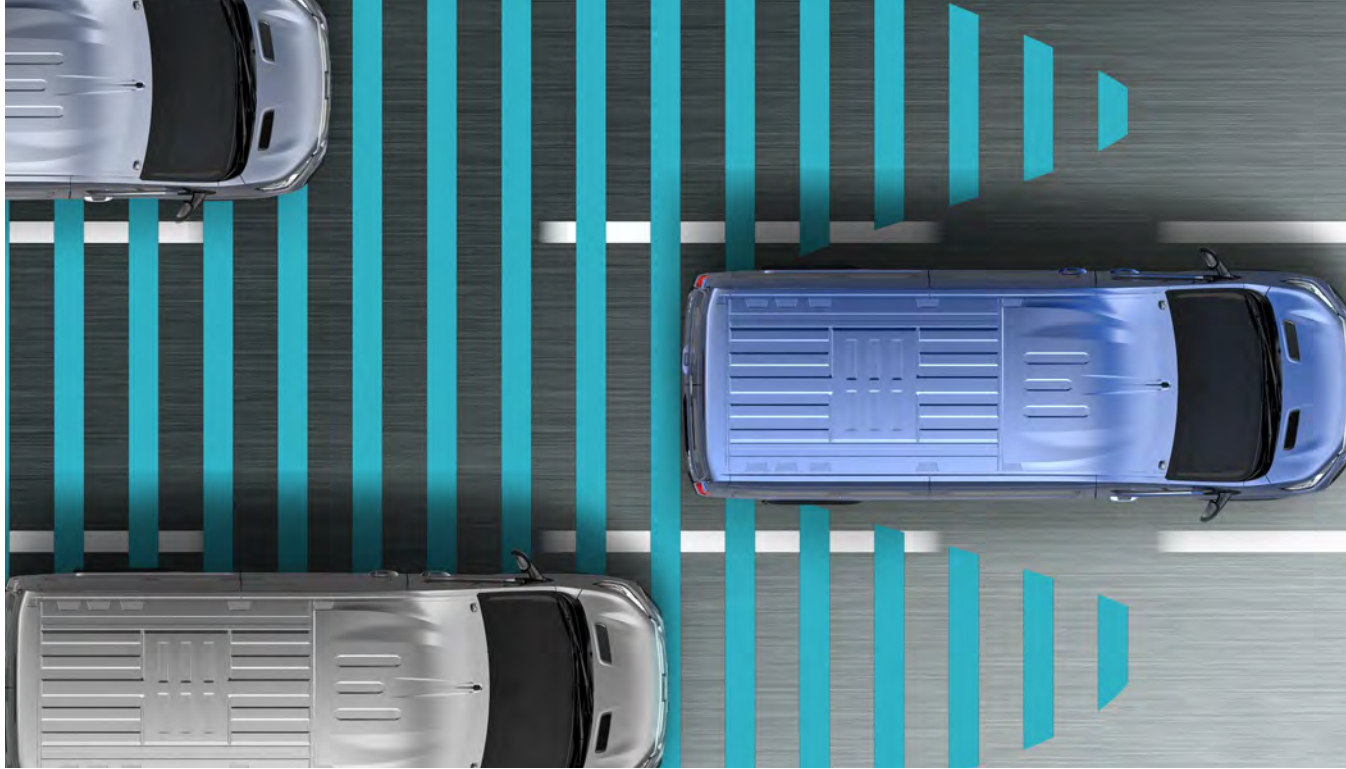

BSD + LCA-BASE VERSION

The Lane Departure Warning System can determine whether the van is changing lane, even in low-visibility weather conditions. In the event of danger, an acoustic and visual signal alerts the driver of the potential impending threat.



STRUCTURE

9.2m laser welding, the longest in the industry. 54% high-strength steel and PHS. Accumulated 2 million kilometres of whole vehicle full environment test verification.



HIGH BEAM RECOGNITION

This manages the activation and deactivation of the main beam headlights, increasing visibility and reducing the risk of dazzling when driving at night, automatically recognising vehicles driving in the opposite direction.



ELECTRIC HEATED SIDE MIRROR

Heated electrically operated door mirrors ensure great rear visibility in all weather conditions.



TRACTION

Traction control system that improves the vehicle's traction on the most challenging surfaces with poor grip. Under conditions of low grip from any drive wheel, the control unit detects slipping and brakes it, transmitting the drive torque on the wheel with brakes, grip on the ground. In this way, the vehicle's performance is more comfortable.

TAKE YOUR PICK

3 years paint warranty
10 years anti - corrosion warranty

MAXUS continuously invests in the use of new materials, state-of-the art painting and cutting-edge manufacturing processes to ensure our vehicles deliver for our customers today, tomorrow and for many years to come.

The Deliver 9 come with 4 paint colour options standard colour Blanc White, and a cost option for metallic / customised paints, Ocean Blue, Aurora Silver and Olive Brown
* denotes cost option



Olive Brown
Metallic body colour*



Blanc White



Ocean Blue
Metallic body colour*



Aurora Silver
Metallic body colour*

Images shown are for illustration purposes only

EU MODEL	SM VAN	MH VAN	LH VAN	LXH VAN	LH VAN	LXH VAN	MC CAB	LC CAB
	FWD	FWD	FWD	FWD	RWD	RWD	RWD	RWD
Dimensions								
Overall length (A)	5180	5546	5940	5940	5940	5940	6200	6680
Overall width with mirrors (B)	2466	2466	2466	2466	2466	2466	2466	2466
Overall height (C)	2385	2555	2535	2755	2535	2755	2320	2320
Wheelbase (D)	3000	3366	3760	3760	3760	3760	3760	4048
Length cargo space (mm) (E)	2650	3019	3413	3413	3413	3413	3673	4153
Max width cargo space (mm)(F)	1800	1800	1800	1800	1800	1800	-	-
Max width cargo space between wheel arches (mm) (G)	1366	1366	1366	1366	1366	1366	-	-
Max height cargo space (mm) (H)	1724	1892	1892	2114	1792	2014	-	-
Slide door width (mm) (I)	1075	1269	1269	1269	1269	1269	-	-
Slide door height (mm) (J)	1560	1670	1670	1670	1570	1570	-	-
Turning radius (m)	12.1	13.4	14.8	14.8	14.1	14.1	14.1	15.2
Cargo volume (m ³)	8.13	10.2	11.55	12.91	10.97	12.33	-	-
Rear door entry width	1570	1570	1570	1570	1570	1570	-	-
Rear door entry height	1570	1756	1756	1964	1656	1864	-	-
Front overhang (mm) (K)	1020	1020	1020	1020	1020	1020	-	-
Rear overhang (mm) (L)	1160	1160	1160	1160	1160	1160	-	-
Rear step height (mm)								
Others								
Fuel tank capacity (Litres)	80	80	80	80	80	80	80	80
Number of seats	3	3	3	3	3	3	3	3
Max speed (km/h)	160	160	160	160	145	140	-	-
Max speed (mph/h)	100	100	100	100	90	87	90	90
Tyres	215/75R16C	215/75R16C	215/75R16C	215/75R16C	215/75R16C	215/75R16C	215/75R16C	215/75R16C
Tyre Load / Speed Index	121/119s	121/119s	121/119s	121/119s	121/119s	121/119s	121/119s	121/119s

"-" means the data is still under testing.

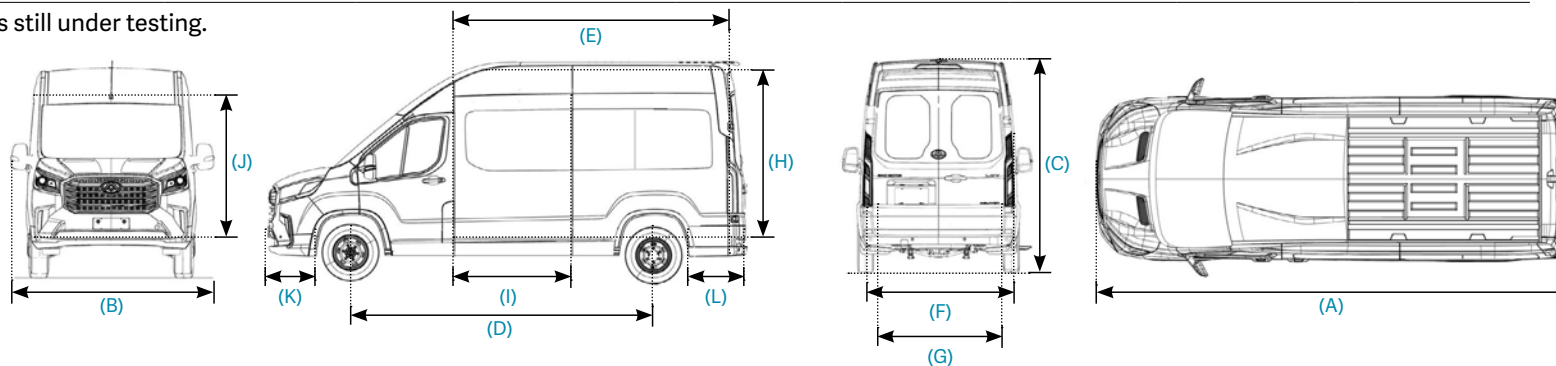

EU MODEL	SM VAN	MH VAN	LH VAN	LXH VAN	LH VAN	LXH VAN	MC CAB	LC CAB
	FWD	FWD	FWD	FWD	RWD	RWD	RWD	RWD
ENGINE								
Capacity (cc)					1996			
Cylinders/Volves					4/16			
Max power (kW / rpm)	120	120	120	120	120	120	110	110
Max torque (Nm / rpm)	375	375	375	375	375	375	375	375
Fuel system	D2.0L Turbo Diesel Direct Injection							
Euro status	Euro 6d							
Stop & Start System	Yes							
TRANSMISSION								
Gearbox	Manual							
Number of gears	6							
ECONOMY Litres/100km								
Low	-	-	-	-	11.2	11.2	-	-
Medium	-	-	-	-	9.1	9.2	-	-
High	-	-	-	-	8.5	8.8	-	-
Extra high	-	-	-	-	10.9	11.7	-	-
Combined	-	-	-	-	9.8	10.2	-	-
CO2 EMISSIONS (g/km)								
Low	-	-	-	-	294	292	-	-
Medium	-	-	-	-	239	241	-	-
High	-	-	-	-	222	231	-	-
Extra high	-	-	-	-	281	306	-	-
Combined	-	-	-	-	256	268	-	-
WEIGHTS								
Gross vehicle weight GVW (kg)	3500	3500	3500	3500	3500	3500	3500	3500
Kerb weight (kg) excluding driver	2140	2210	2260	2300	2360	2390	1980	2020
Max front axle load (kg)	1950	1950	1950	1950	1950	1950	1950	1950
Max rear axle load (kg)	1900	1900	1900	1900	2440	2440	2180	2180
Payload (kg)*	1360	1290	1240	1200	1140	1110	1520	1480
Gross train weights (GTW)	5500	6000	6000	6000	6000	6000	6000	6000
Towing capacity (braked) (kg)	2500	2800	2800	2800	2800	2800	2800	2800
Towing capacity (unbraked) (kg)	750	750	750	750	750	750	750	750
BRAKES Front/Rear					Front/Rear Disc Brake			

*Excludes Driver

DELIVER 9

CUSTOM VEHICLE OPTIONS



If your business requires a bespoke vehicle to match your specific working environments, MAXUS has a network of specialist converters that will work with you to create the conversion that best suits your needs. Whether an electric vehicle, drop side, tipper, ambulance, wheelchair accessible minibus or camper van, MAXUS offers you the choice to work with our in-house teams or one of our nationwide dealers or converters. Whichever avenue you choose, MAXUS will work with you through the entire process, from design to delivery, letting you concentrate on more important business - your business.

Working with MAXUS offers your business the reassurance and guarantee that each and every step of the way your design needs will be dealt with by professionals in this field.





IRL **MAXUS**
www.880maxus.co.uk



MAXUS SERVICES

Warranty

5 Years Warranty

Your vehicle is covered by a warranty package for 5 years or 125,000 miles (200,000 Kms) from date of first registration. Your MAXUS Dealer or MAXUS EV Dealer is able to repair or replace, without charge, parts that are found to have a material or assembly defect that is recognised by MAXUS. The paintwork warranty runs for 3 years and the anti-corrosion warranty for 10 years.

For full warranty terms and conditions please visit MAXUS website /warranty.

MAXUS Assist

5 Years MAXUS Assistance

Should you need it, we'll provide emergency roadside repairs or recover you to the nearest MAXUS Dealer or MAXUS EV Dealer. This service is available 24 hours a day and is provided for 5 years or 125,000 miles (200,000 Kms) from the date of first registration, whichever comes first. Assistance is provided within the UK & Northern Ireland only at roadside and home and includes national recovery to nearest dealer or Home dealer. Assistance applies to mechanical or electrical defects which are covered by warranty.

Service Intervals

DELIVER 9 Diesel Service: 3 months free inspection. Then 12 months or 18,645 miles (30,000 Kms) thereafter. MAXUS Dealer Network Services. No-one is better placed than MAXUS to maintain, fit and repair your Deliver 9 fast. MAXUS Dealers repair and maintenance and offer a full year's guarantee on Original MAXUS Parts. And don't forget to have a look at our wide range of additional equipment and accessories!

MAXUS Auto care

MAXUS Auto Care is an innovative Service, Maintenance & Repair product that supplies business customers with a fully supported, hassle-free service and maintenance package. MAXUS Auto Care is a "Pay-As-You-Go" product that ensures your vehicle is maintained by MAXUS technical experts when work is required.

MAXUS Auto Care provides the following benefits:

- Full service, maintenance and repair cover
- Tyres can be included within the contract at an additional fixed cost
- Ancillary equipment can also be included (at an additional fixed monthly cost)
- Excludes: Damage/Neglect/Abuse/Glass and bulbs
- A fixed, pre agreed pence per mile rate
- No excess mileage charges at the end of the contract
- No pooled mileage administration
- Minimises downtime

For more information and to obtain a quote based on your requirements, please speak to your local MAXUS Auto Care dealer or visit the MAXUS website.

Customer Relations

MAXUS knows the value of communicating with its business customers and we have established effective ways to support you and your business. Speak to your local MAXUS dealership, if you are not completely satisfied, please contact the MAXUS UK office on 0800 246 5888.

(Mon-Fri 9.00am to 5.30pm, Closed on Bank Holidays).

You can also visit our website:

www.saicmaxus.co.uk
www.saicmaxus.ie

Or write to us at:

maxusfleet@saicmaxus.co.uk

MAXUS HQ, Harris Auto Distributors, Naas Road, Dublin, D12 V065, Ireland.

MAXUS Finance Options

There is a wide variety of ways to purchase a new vehicle.

Your local MAXUS dealer can help arrange :
HP, Contract Hire, Leasing

Finance offers available to all , so whether you're a fleet buyer or private buyer, MAXUS dealers are ideally placed to tell you which plan or combination of plans best suits your needs and circumstances.

Subject to status, terms and conditions apply.

Contact your local MAXUS dealer or MAXUS Website for further details.



Your local dealer



**HARRIS AUTOMOTIVE
DISTRIBUTORS U.C.**

FIND US @     

MAXUS Disclaimer:

Images shown in this brochure are for illustration purposes only. Actual vehicles may differ and are subject to change.

Specifications, standard equipment, options, fabrics and colours are subject to change without notice.

Some features may be unavailable when your vehicle is built. Some vehicles are pictured with options that may be available at extra cost or may not be available on certain models. Ask about availability of options and verify that the vehicle you ordered includes the equipment you ordered.

*5 year/125,000 mile (200,000 Kms) warranty and 5 years roadside assistance. Terms and conditions apply.

www.saicmaxus.co.uk

www.saicmaxus.ie



MAXUS
eDELIVER 9

MAXUS
eDELIVER 3



MAXUS eDELIVER RANGE

THE PURE DRIVING EXPERIENCE



MANUFACTURER

Innovative, thought-leading, and future-focused, Shanghai Automotive Industry Corporation (SAIC) is the largest automotive group in China, and is the name behind the MAXUS (formerly LDV) brand.

Based in Shanghai, SAIC produces almost seven million vehicles each year for both domestic and international markets and is a Fortune Global 500 listed company with almost 100,000 employees.

With a long history tracing back to the 1940s, SAIC saw real growth from the mid-1980s onwards following a number of partnerships that allowed it to produce competitive vehicles by utilising the latest technology.

The company has a number of well-known brands within its portfolio including, since 2010, the acclaimed MAXUS range of LCVs. SAIC has invested more than €2 billion in this brand, with a strong focus on safety, innovation and the introduction of new products to the range, including a suite of EVs that are already setting the standard for the future of eco-fuelled commercial motoring.

Since acquiring LDV, these LCVs were manufactured under the MAXUS moniker for the home market in China in addition to selected left hand drive markets in Europe such as Spain, Belgium and The Netherlands. In April 2020, LDV rebranded as MAXUS across right hand drive Europe, coinciding with the launch of the all-new eDELIVER 9 and the newest EV in the brand's stable, the eDELIVER 3, thereby consolidating the brand's presence across Europe, China and beyond.

With an even brighter future ahead, SAIC's key areas of development are electrification, car sharing, connectivity and globalisation. Today, there are eight major automotive groups within SAIC, including SAIC MAXUS.

SAIC's vision is to continue to build an innovative, globally-recognised company that pioneers the future of the automotive industry, actively promoting new energy vehicles.

DISTRIBUTOR

You are the expert in your field but when it comes to automotive expertise, The Harris Group is here to guide you through your search for the right vehicle for your business. One of the longest-established automotive distribution and assembly companies in Ireland and the UK, The Harris Group was founded in 1961 and is an industry leader in the commercial and fleet sectors.

The privately-owned company is best known for its commercial vehicle brands that include Hino, Sinotruk, Higer, Isuzu, AOS and Crusader. In 2016, The Harris Group acquired the distribution rights to MAXUS (formerly LDV) across right hand drive Europe and the range of LCVs, which includes market-leading electric vehicles, has taken the market by storm.

The Harris Group has developed an unrivalled reputation for service excellence in the UK and Ireland, which comes from almost 60 years of experience. Harris is the distributor for the MAXUS range of vehicles in the UK, Ireland, Channel Islands, Isle of Man, Malta and Cyprus.



OUR NETWORK

With a strong dealer network of dedicated and experienced commercial vehicle specialists, we offer the highest standards of expertise whether you are looking to buy one van or an entire fleet.

Following a high-profile relaunch of the LDV brand in 2016, Harris is continuing to build its network across all right hand drive markets in Europe.

Today, the Group represents the MAXUS range in a total of seven territories, including the UK, Ireland, Channel Islands, Isle of Man, Malta and Cyprus, with the company focussed on a big drive to expand the dealer network throughout the UK.

Every dealer within the company's network operates with a strong focus on after-sales activities, thereby ensuring complete customer satisfaction.

Check out www.saicmaxus.co.uk to find your local dealer.







MAXUS



THE PURE DRIVING EXPERIENCE

BLE ENERGY EFFICIENT PURE UNLIMITED RENEWABLE ENERGY EFFICIENT PURE UNLIMITED RENEWABLE ENERGY EFFICIENT
AT PURE UNLIMITED RENEWABLE ENERGY EFFICIENT PURE UNLIMITED RENEWABLE ENERGY EFFICIENT
ED RENEWABLE ENERGY EFFICIENT PURE UNLIMITED RENEWABLE ENERGY EFFICIENT
BLE ENERGY EFFICIENT PURE UNLIMITED RENEWABLE ENERGY EFFICIENT
AT PURE UNLIMITED RENEWABLE ENERGY EFFICIENT PURE UNLIMITED RENEWABLE ENERGY EFFICIENT

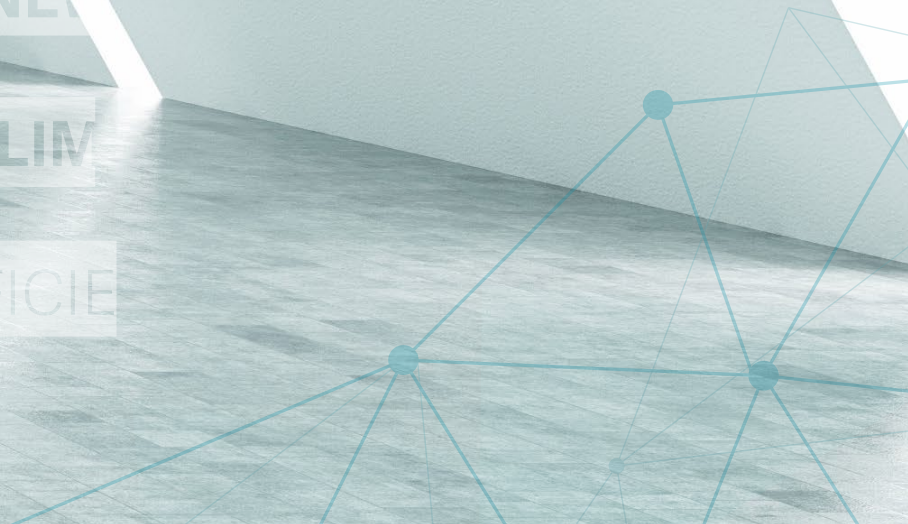

HIGH POWER LOW ENERGY MOTOR

MAXUS
eDELIVER 3

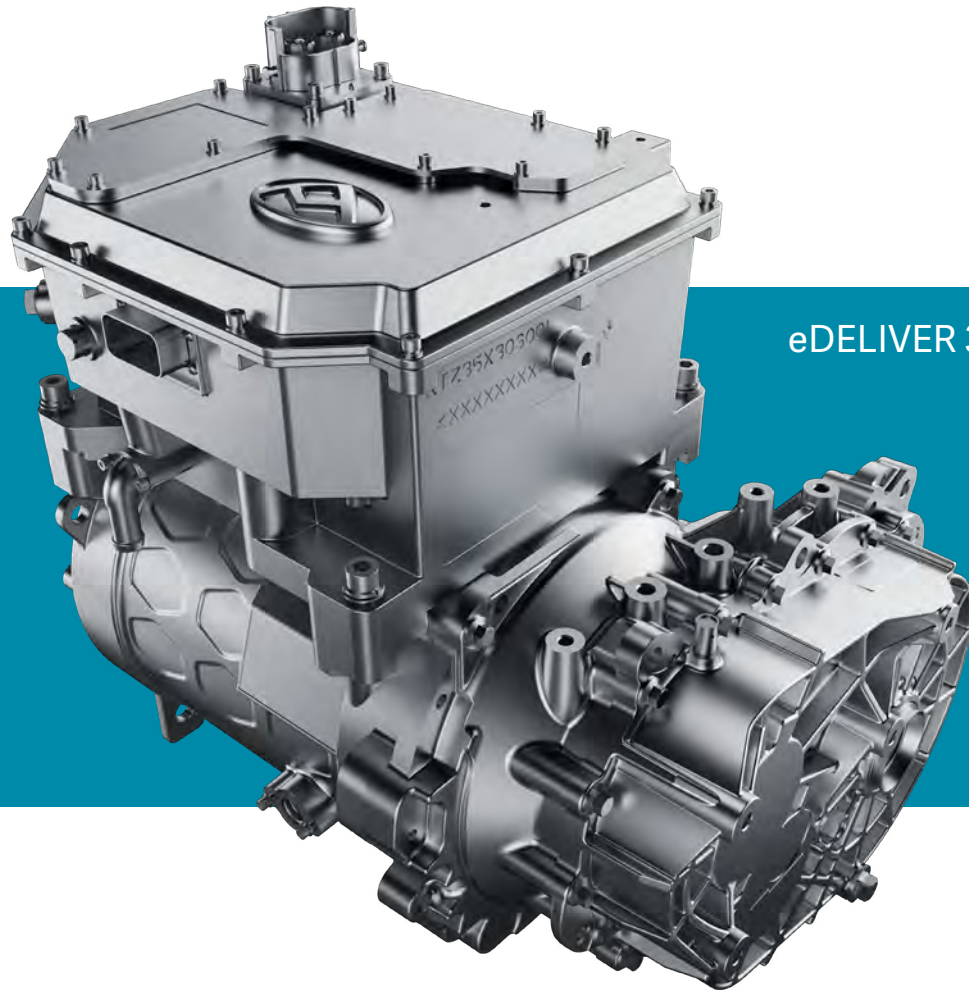

eDELIVER 3

ELECTRIC POWERTRAIN

HIGH POWER LOW ENERGY MOTOR

The maximum power is 90kW; the peak torque is 255N·m; the acceleration time of 0-100km/h is 11s.

PROVIDE DC + AC DUAL CHARGING MODE

DC mode: 45 minutes can charge 80% of electricity, 80 minutes can be charged to 100%.

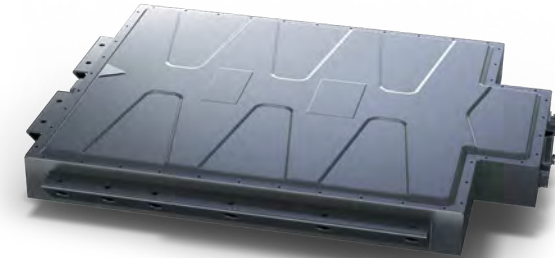

35kWh BATTERY

CATL



52.5kWh BATTERY

SAIC are the leaders in the technical revolution, continually leading the way in the development of new technology and solutions for the automotive industry.

A part of that revolution is being the market leaders in battery technology, we have developed a number of battery options for the eDELIVER 3, by using various battery cooling methods, which allows us to reduce charging time (DC 45mins (5%-80%) AC 5hrs), extend battery life and increase the operating range.

The eDeliver 3 comes with a 90KW /255Nm motor, AC/DC charging options and a choice of 35Kw or 52.5kw battery configurations.



STORAGE SYSTEM

The new Maxus eDELIVER range of vehicles offer all the storage you need to keep your cab area neat & organised. There is a place for everything, in addition to the glovebox there are storage areas in the door pockets to keep things close to hand. Larger items can be stored under the seats in both the eDELIVER 3 & the eDELIVER 9. In the eDELIVER 9 there is the added bonus of a folding seatback which reveals two further cup-holders and a handy tablet holder.

- USB port and mini jack port¹ (driver and passenger)
- Storage space under the bench seat
- Storage compartments in the doors
- Cup holder (driver and passenger)
- 12 V power socket





The Infotainment System takes the MAXUS eDELIVER 3 driving experience from ordinary to extraordinary

MAXUS eDELIVER 3 model offers a pure driving experience that any van driver will appreciate. Professional drivers have busy and often long days, and this is why the eDELIVER 3 cabin area offers all the comfort and practicality of a mobile office space.

Packed with cutting edge technology and practical features, you'll have everything you need and all operated at the touch of a button via touch screen. In addition to the radio functions, the high spec includes USB ports for both the driver and passenger, so you can always remain connected whether

by laptop or by simply hooking up your smartphone to the system. A ready-to-go mobile office space. Use the link to access all your apps and emails, apple carplay™ and android auto adaptable.

MAXUS
eDELIVER 3

MULTI-FUNCTION STEERING WHEEL

MULTI FUNCTION STEERING WHEEL

Make use of important features using the multi-function steering wheel whilst keeping full control of your vehicle. Answer and hang-up your mobile phone, control the volume of the stereo and manage the cruise control functions whilst keeping both hands on the steering wheel.

CRUISE CONTROL

Cruise Control allows you to set the cruising speed and keep it constant.



DRIVERS' ENVIRONMENT COMFORT AND SAFETY

COOL, CALM AND IN CONTROL

Stay cool at all times with the eDELIVER air conditioning system with our ever-changing climate, the importance of a good air conditioning system was always going to be a factor when it came to designing this vehicle. The eDELIVER models include manual air conditioning for your comfort and the comfort of your passengers. The variable control of the air conditioning system ensures that the temperature can be adjusted to the desired level easily and quickly. So you can always rely on a pleasant work environment, whatever the weather.

Unique design, aluminium monocoque frame, composite plastic front panels for maximum payload and durability.

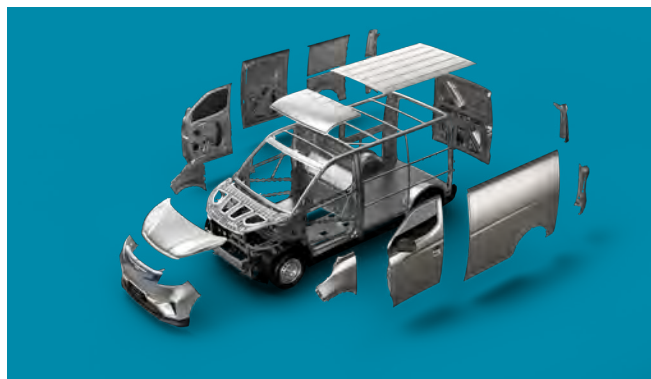



COMPREHENSIVE SAFETY STANDARDS

At MAXUS, safety is paramount and the eDELIVER 3 meets all European commercial vehicle collision design standards.

Advanced driver assistance system as standard with the latest generation of ESP Electronic Stability Program and delivers comfort and peace of mind in any situation.

- 7 Inch Touch Screen
- Daytime Running Lamp
- Driver and Passenger Airbag*
- Driver-S/Belt Reminder
- Eco Drive Mode Setting
- ESC (ESP)
- Hand Brake
- Multifunction Steering Wheel
- Visual Reversing Camera
- Rear Proximity Sensor
- Tyre Pressure Monitoring System

MAXUS
eDELIVER 3

MAXUS eDELIVER 3



eDELIVER 3 MODEL Standard Equipment

- 2 Driving Modes
- 3 Energy Recovery Modes
- 6 Cargo Area Floor Strapping Rings
- Cargo Area Partition (Optional With Glass)
- Daytime Running Lights
- Driver Airbag
- Driver Seatbelt Lock Reminder
- Electric Adjustment Of Outside Mirror
- Electric Power Assisted Steering
- Electric Windows
- ESC - Electronic Stability Control
- Front & Rear Ventilated Discs
- Front McPherson Independent Suspension
- Front Passenger Airbag



- 7 inch Screen
- Handbrake
- Immobiliser
- Multifunction Steering Wheel
- Rake Adjustable Steering Wheel
- Rear Leaf Spring Suspension
- Reversing Camera
- Rear Parking Sensors
- Stainless Steel Cargo Area Floor
- Ternary Polymer Lithium Battery



MAXUS eDELIVER 3

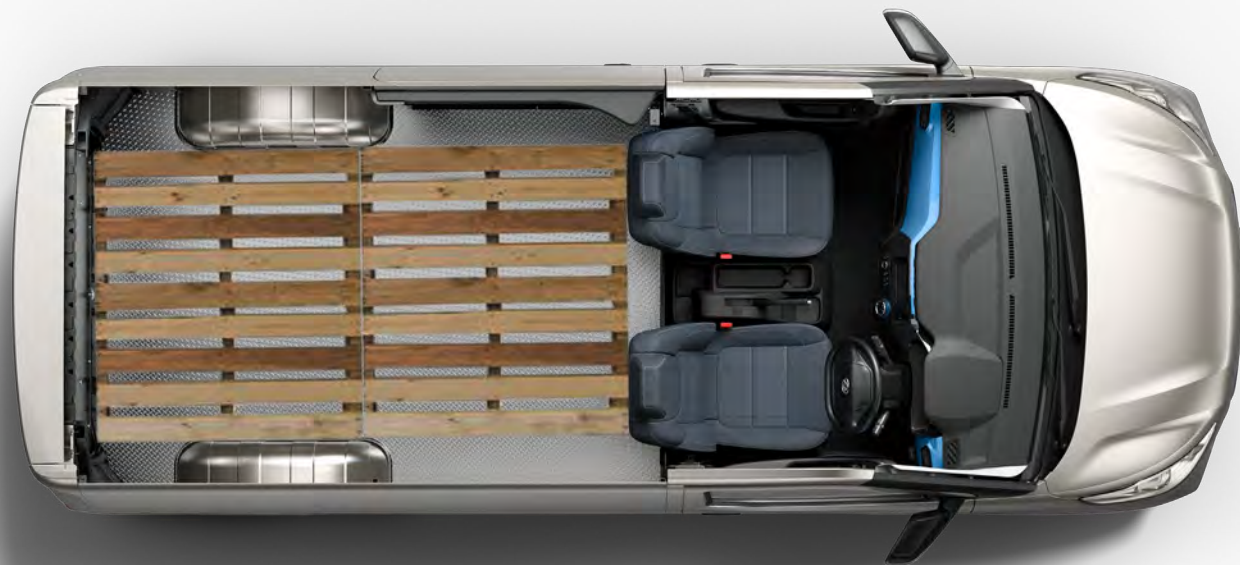

LOADING COMPARTMENT

The width of the compartment is 1665mm. The cargo area offers optimal ease of loading with the short wheelbase for the van of 4.8 cubic metres and the long wheel base of 6.3 cubic metres.



eDELIVER 3 MODEL Body Structure

The design uses aerodynamic principles to reduce wind resistance and lighten the entire vehicle. A large number of aluminum alloys and polymer composite materials are used. Strong design with emphasis on strength and payload

MAXUS
eDELIVER 3

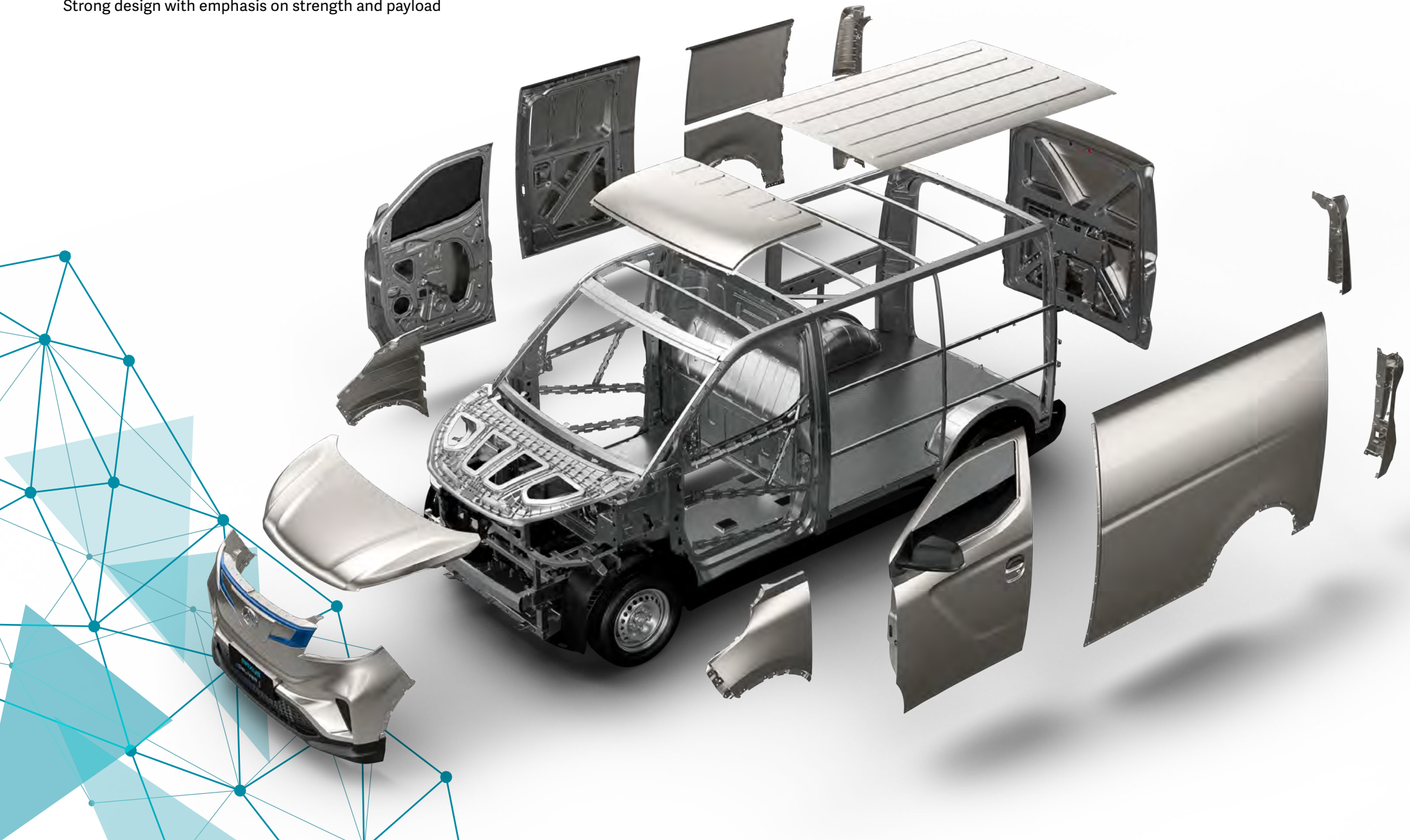

MAXUS e DELIVER 3	SWB 35kWh	SWB 52.5kWh	LWB 35kWh	LWB 52.5kWh	Chassis cab 52.5kwh
WEIGHTS					
GVM (kg)	2310	2460	2550	2630	2630
CVW (kg)	1455	1555	1530	1640	1428
Max front axle load (kg)	1170	1170	1170	1170	1180
Max rear axle load (kg)	1260	1460	1460	1460	1460
Payload (kg)	865	905	1020	990	1202
Max roof load (kg)	75	75	100	100	/
Towing capacity (unbraked) (kg)	/	/	/	/	/
ENGINE					
Drive type	RHD	RHD	RHD	RHD	RHD
Number of seats	2	2	2	2	2
Rated power/peak power (kW)	40/90	40/90	40/90	40/90	40/90
Rated torque/Max. torque (N.m)	125/255	125/255	125/255	125/255	125/255
Max speed (kmph /mph)	120/75	120/75	120/75	120/75	120/75
Acceleration 0-100km/h (sec)	11	12	12	13	TBC
GEAR RATIOS	Internal Gearbox Ratios	Final Drive Ratios	Total Gear Ratio		
Max CVT	N/A	N/A	N/A		
1	2.5	3.739	9.348		
Min CVT	N/A	N/A	N/A		
Reverse	2.5	3.739	9.348		
DIMENSIONS					
Dimension : L *W *H (mm)	4555X1780X1895	4555X1780X1895	5145X1780X1900	5145X1780X1900	5037X1780X1866
Wheel base (mm)	2910	2910	3285	3285	3285
Length cargo space (mm)	2180	2180	2770	2770	/
Max width cargo space (mm)	1665	1665	1665	1665	/
Max width cargo space between wheel arches (mm)	1220	1220	1220	1220	/
Max height cargo space (mm)	1330	1330	1330	1330	/
Slide door width (mm)	710	710	710	710	/
Slide door height (mm)	1230	1230	1230	1230	/
Turning radius (m)	5.87	5.87	6.53	6.53	6.53
Cargo volume (m³)	4.8	4.8	6.3	6.3	/
CHARGING					
Charging time(AC 100%) h	6	8	6	8	8
Charging time (DC 80%) min	45	45	45	45	45
Battery capacity (kWh)	35	52.5	35	52.5	52.5
Energy consumption WLTP combined (Kwh/100km)	24.36kwh/100km	23.63kwh/100km	26.15kwh/100km	25.31kwh/100km	TBC
RANGE					
WLTP City Range	141 Miles/ 227 KMS	213 Miles/ 344 KMS	132 Miles/ 213 KMS	197 Miles/ 318 KMS	/
WLTP Combined Range	99 Miles/ 159 KMS	151 Miles/ 243 KMS	95 Miles/ 153 KMS	141 Miles/ 232 KM4	/

LOADING COMPARTMENT

eDELIVER 3



180° Opening Angle

60/40 Split Doors

Loading Eyes

Counter Sunk Lashing Rings

Non Slip Flooring

LED Signature Parking Lamp

Rear Parking Sensors

eDELIVER 3 MODEL

3 years paint warranty
10 years anti - corrosion warranty

MAXUS continuously invests in the use of new materials, state-of-the-art painting and cutting-edge manufacturing processes to ensure our vehicles deliver for our customers today, tomorrow and for many years to come.

TWO SIZE OPTIONS



SWB (4555mm Overall Length)

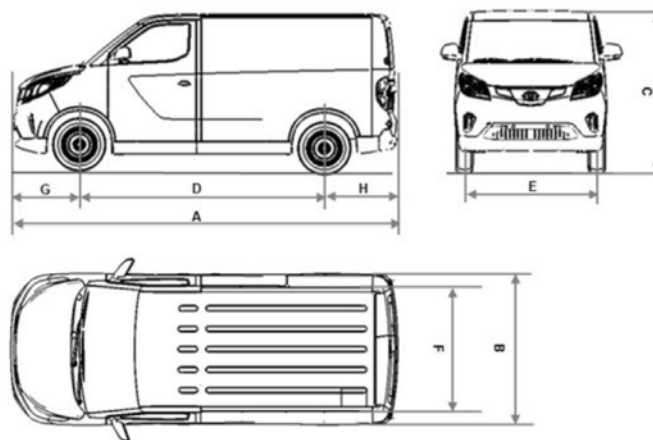

Length (A)	4555
Width (B)	1780
Height (C)	1895
Wheel Base (D)	2910
Track - 1st axle (E)	1548
Track - 2nd axle (F)	1553
Front Overhang (G)	780
Rear Overhang (H)	865



LWB (5144mm Overall Length)

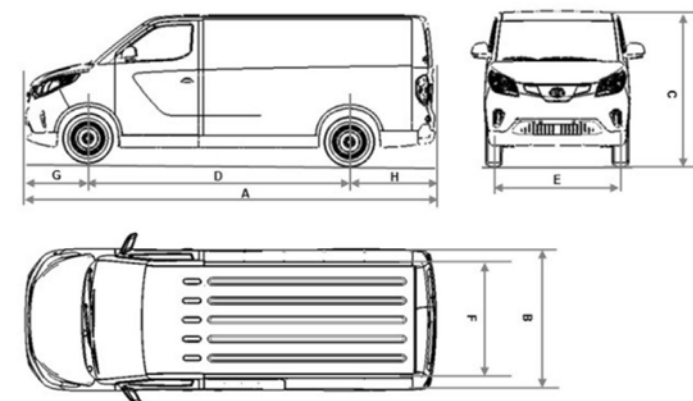

Length (A)	5145
Width (B)	1780
Height (C)	1900
Wheel Base (D)	3285
Track - 1st axle (E)	1548
Track - 2nd axle (F)	1553
Front Overhang (G)	780
Rear Overhang (H)	1080



MAXUS



MAXUS
eDELIVER 9

THE PURE
DRIVING EXPERIENCE



HIGH POWER 150KW LOW ENERGY MOTOR

MAXUS
eDELIVER 9

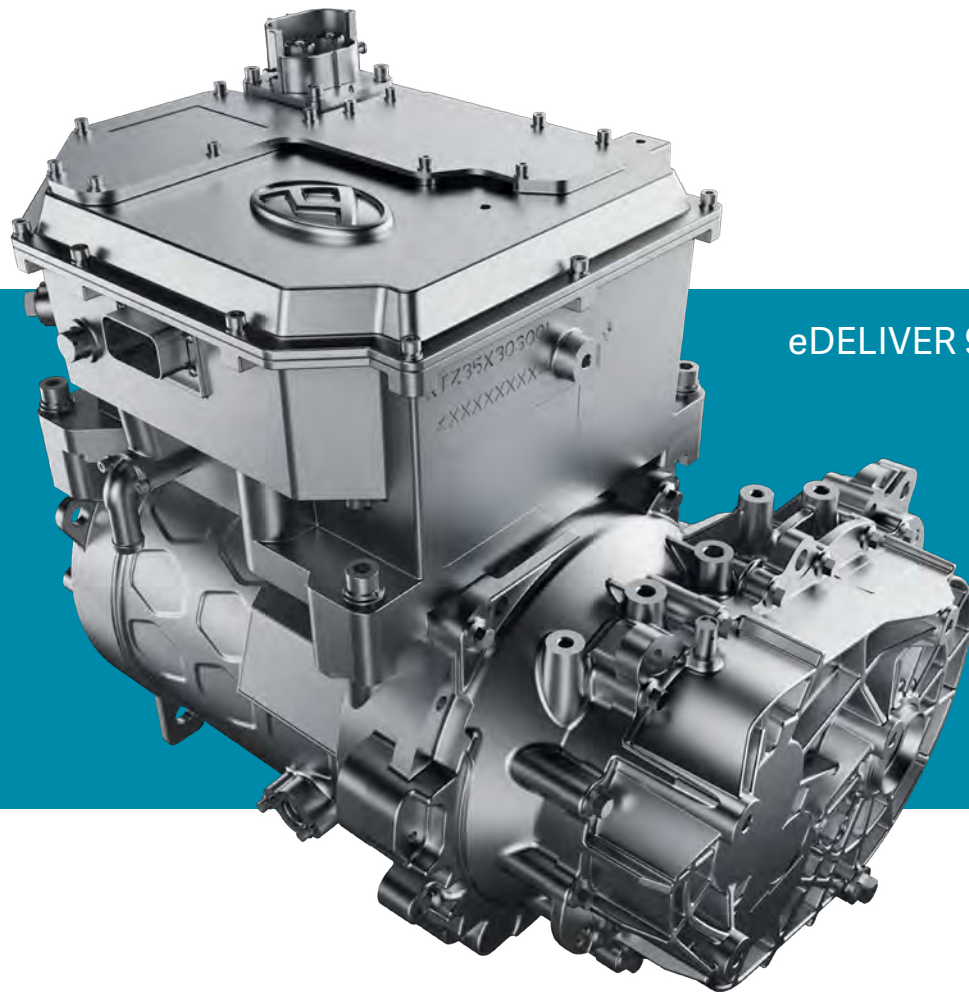

eDELIVER 9

ELECTRIC POWERTRAIN

HIGH POWER LOW ENERGY MOTOR

The Maximum Power is 150Kw , the peak torque is 310Nm” and change the 0-100kms/hr to 0-50kms/hr and the time from 11secs to 5.7secs.

PROVIDE DC + AC DUAL CHARGING MODE

DC mode: 45 minutes can charge 80% of electricity,80 minutes can be charged to 100%.



51.5KWH BATTERY

CATL



72kWh OR 88.55kWh BATTERY

SAIC are the leaders in the technical revolution, continually leading the way in the development of new technology and solutions for the automotive industry.

A part of that revolution is being the market leaders in battery technology, we have developed a number of battery options for the eDELIVER 9, by using various battery cooling methods, which allows us to reduce charging time (DC 45mins (5%-80%) AC 5hrs), extend battery life and increase the operating range.

The eDELIVER 9 comes with a 150Kw / 310Nm motor and a choice of 3 batteries configurations, 51.5Kwh, 72Kwh and 88.55 Kwh with A/C & DC charging as standard.

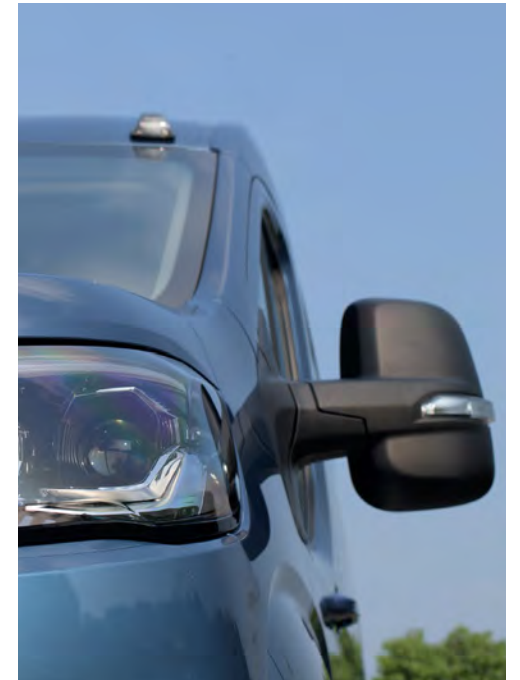



eDELIVER 9 MODEL

Standard Equipment



- 10 Inch Touch Screen
- 16" Alloy Wheels
- 236° Opening Angle (with Limited Gemel)
- 8-direction Adjustable Driver's Seat with armrest
- Adaptive Cruise Control (Optional)
- Adjustable non-Pretightening Belt
- Adjustable Overspeed Alarm
- Air conditioning
- Auto Latch (8mp/h)
- Automatic Emergency Braking System (Optional)
- Automatic Off Headlights
- B Column Full Steel Unglazed Partition
- Blind Area Monitoring System
- Body Colour Handles
- Central Lock
- Chrome Front MAXUS Hexagonal Signature Grill
- Cruise Control System
- Driver and Passenger Safety Belt Buckle Reminder

- Driver Seat Airbags
- Driving Model (Power/Normal/Eco)
- Duel Cargo light
- eCall
- Electric Front Windows
- Electric Power Steering
- Electric Side Step (Optional)
- ESP+EBA+BAS+HHC
- Front Body-Colour Bumper
- Front Double Curtain Airbag
- Front Passenger Airbags
- Ignition-off Auto Unlock
- Infotainment System
- Intelligent Anti-Theft Security System
- Lane Change Assist System
- Lane Departure Warning System (Optional)
- LED Day Time Running Light
- LED Headlights

- Multifunction steering wheel
- No Key Entry and Start System
- Outside Rearview Mirror (Natural Colour) Electric
- Parking Sensor (front and back)
- Parking Sensor (Rear Only)
- Passenger Adjustable non-Pretightening Belt
- Rear Bumper Nature Colour
- Rear Fog Lamp
- Reverse Camera with Guide Assist
- Seat Fabric (Knit/Gray)
- Single-Side Sliding Door
- Smoker Pack
- Tie Down Points (8)
- Tyre Pressure Monitoring System
- Reversing Camera
- Wear Resistant Floor

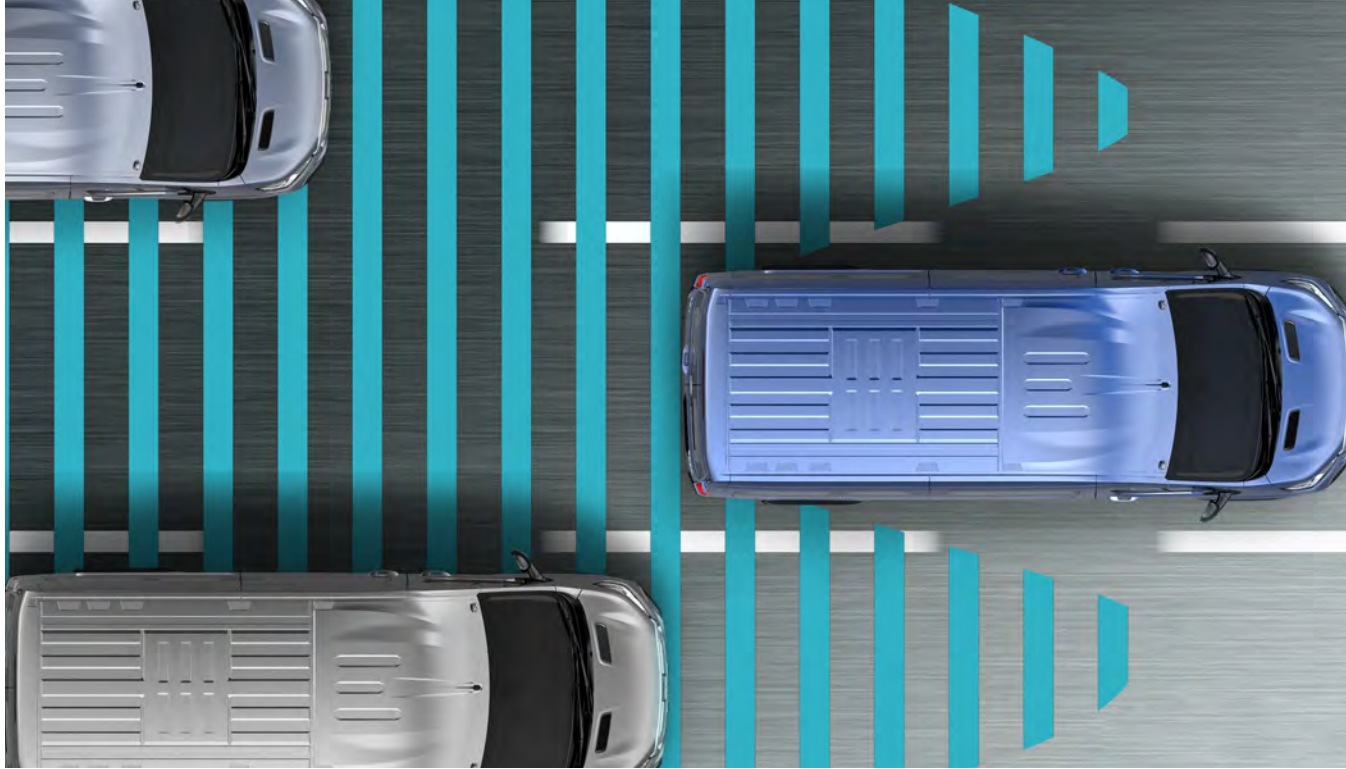

MAXUS eDELIVER 9

BSD + LCA-BASE VERSION

The Lane Departure Warning System can determine whether the van is changing lane, even in low-visibility weather conditions. In the event of danger, an acoustic and visual signal alerts the driver of the potential impending threat.



HIGH BEAM RECOGNITION

This manages the activation and deactivation of the main beam headlights, increasing visibility and reducing the risk of dazzling when driving at night, automatically recognising vehicles driving in the opposite direction.



ELECTRIC HEATING SIDE MIRROR

Heated electrically operated door mirrors ensure great rear visibility in all weather conditions.



STRUCTURE

9.2m laser welding, the longest in the industry. 54% high strength steel and PHS. Accumulated 2 million kilometres of whole vehicle full environment test verification

MAXUS eDELIVER 9

MAXUS eDELIVER 9	MH		LH		LH
	Capacity (kWh) 51.5kWh	Capacity (kWh) 72kWh	Capacity (kWh) 51.5kWh	Capacity (kWh) 72kWh	Capacity (kWh) 88.55kWh
WEIGHTS					
GVM (kg)	3500	3500	3500	3500	3500
CVW (kg)	2300	2460	2340	2520	2640
Max front axle load (kg)	1950	1950	1950	1950	1922
Max rear axle load (kg)	1900	1900	1900	1900	1828
Payload (kg)	1200	1040	1160	980	860
Towing capacity (unbraked) (kg)	1500 (750)	1500 (750)	1500 (750)	1500 (750)	1500 (750)
ENGINE					
Drive Type	RHD/LHD	RHD/LHD	RHD/LHD	RHD/LHD	RHD/LHD
Number of seats	3	3	3	3	3
Rated power/peak power (kW)	70/150	70/150	70/150	70/150	70/150
Rated torque/Max. torque (N.m)	160/310	160/310	160/310	160/310	160/310
Max speed (km/h)	100	100	100	100	100
Acceleration 0-50km/h (sec)	5.7	5.7	5.7	5.7	5.7
DIMENSION					
Dimension :L *W *H (mm) (A,B, C)	5546*2062*2525	5546*2062*2525	5940*2062*2525	5940*2062*2525	5940*2062*2525
Wheel base (mm) (D)	3366	3366	3760	3760	3760
Length cargo space (mm)(E)	3019	3019	3413	3413	3413
Max width cargo space (mm) (F)	1800	1800	1800	1800	1800
Max width cargo space between wheel arches (mm) (G)	1366	1366	1366	1366	1366
Max height cargo space (mm) (H)	1792	1792	1792	1792	1792
Slide door width (mm) (I)	1269	1269	1269	1269	1269
Overhang Front (J) / Rear (k)	1020/ 1160	1020/ 1160	1020/ 1160	1020/ 1160	1020/ 1160
Slide door height (mm) (L)	1570	1570	1570	1570	1570
Turning radius (m)	6.7	6.7	7.4	7.4	7.4
Cargo volume (m ³)	9.7	9.7	11.0	11.0	11.0
CHARGING					
Charging time (AC 100%) h/POWER (11kW)	6	8	6	8	8.5
Charging time (DC 80%) min	40	40	40	40	45
Battery capacity (kwh)	51.5	72	51.5	72	88.55
energy consumption WLTP combined (kWh/100km)	29.44	31.06	29.44	31.06	31.03
RANGE					
WLTP city Miles / (kms)	147 (237)	179 (288)	147 (237)	179 (288)	219 (353)
WLTP Combined Miles / (kms)	112 (180)	146 (235)	112 (180)	146 (235)	185 (296)

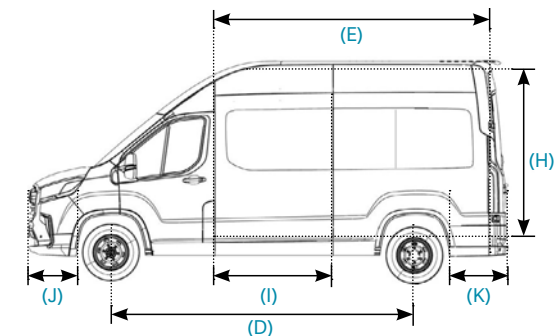
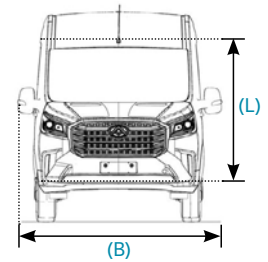
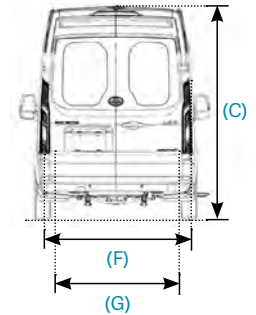
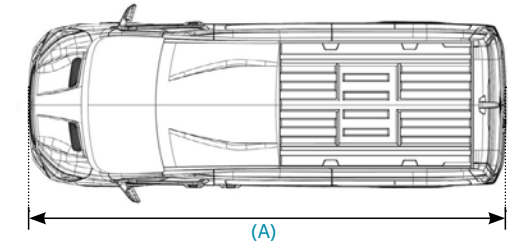

eDELIVER 9

CUSTOM VEHICLE OPTIONS

MAXUS
eDELIVER 9



If your business requires a bespoke vehicle to match your specific working environments, MAXUS has a network of specialist converters that will work with you to create the conversion that best suits your needs. Whether an electric vehicle, drop side, tipper, ambulance, wheelchair accessible minibus or camper van, MAXUS offers you the choice to work with our in-house teams or one of our nationwide dealers or converters. Whichever avenue you choose, MAXUS will work with you through the entire process, from design to delivery, letting you concentrate on more important business - your business.

Working with MAXUS offers your business the reassurance and guarantee that each and every step of the way your design needs will be dealt with by professionals in this field.

MAXUS SERVICES



Warranty

Basic vehicle warranty covers the non Electric Vehicle parts – 5yrs 60,000 miles (100,000 Kms)

Electric vehicle drive train warranty covers all the electric vehicle parts -5yrs 120,000 mile (200,000Kms)

Electric vehicle battery (Li-Ion) capacity coverage covers capacity loss – 8yrs 100,000 (160,000kms)

For t&c's see page 3 of the "Service / Warranty Handbook

Your vehicle is covered by a warranty package for 5 years 60,000 miles (96,000kms) and the Battery 8 years 100,000 miles (161,000 Kms) from date of first registration. Your MAXUS Dealer or MAXUS EV Dealer is able to repair or replace, without charge, parts that are found to have a material or assembly defect that is recognised by MAXUS. The paintwork warranty runs for 3 years and the anti-corrosion warranty for 10 years.

For full warranty terms and conditions please visit MAXUS website /warranty.

MAXUS Assist

5 Years MAXUS Assistance

Should you need it, we'll provide emergency roadside repairs or recover you to the nearest MAXUS Dealer or MAXUS EV Dealer. This service is available 24 hours a day and is provided for 5 years or 125,000 miles (200,000 Kms) from the date of first registration, whichever comes first. Assistance is provided within the UK & Northern Ireland only at roadside and home and includes national recovery to nearest dealer or home dealer. Assistance applies to mechanical or electrical defects which are covered by warranty.

Service Intervals

eDELIVER 3 Service: 12 months or 18,645 miles (30,000 Kms) thereafter. MAXUS Dealer Network Services. No-one is better placed than MAXUS to maintain, fit and repair your eDELIVER 3 fast. MAXUS Dealers repair and maintenance and offer a full year's guarantee on Original MAXUS Parts. And don't forget to have a look at our wide range of additional equipment and accessories!

MAXUS Auto Care

MAXUS Auto Care is an innovative Service, Maintenance & Repair product that supplies business customers with a fully supported, hassle-free service and maintenance package. MAXUS Auto Care is a "Pay-As-You-Go" product that ensures your vehicle is maintained by MAXUS technical experts when work is required.

MAXUS Auto Care provides the following benefits:

- Full service, maintenance and repair cover
- Tyres can be included within the contract at an additional fixed cost
- Ancillary equipment can also be included (at an additional fixed monthly cost)
- Excludes: Damage/Neglect/Abuse/Glass and bulbs
- A fixed, pre agreed pence per mile rate
- No excess mileage charges at the end of the contract
- No pooled mileage administration
- Minimises downtime

For more information and to obtain a quote based on your requirements, please speak to your local MAXUS Auto Care dealer or visit the MAXUS website.

Customer Relations

MAXUS knows the value of communicating with its business customers and we have established effective ways to support you and your business. Speak to your local MAXUS dealership, if you are not completely satisfied, please contact the MAXUS UK office on 0800 246 5888.

(Mon-Fri 9.00am to 5.30pm, Closed on Bank Holidays).

You can also visit our website:

www.saicmaxus.co.uk

www.saicmaxus.ie

Or write to us at:

MAXUS HQ, Harris Auto Distributors, Naas Road, Dublin, D12 V065, Ireland

MAXUS Finance Options

There is a wide variety of ways to purchase a new vehicle.

Your local MAXUS dealer can help arrange :

HP, Contract Hire, Leasing

Finance offers available to all , so whether you're a fleet buyer or private buyer, MAXUS dealers are ideally placed to tell you which plan or combination of plans best suits your needs and circumstances.

Subject to status, terms and conditions apply.

Contact your local MAXUS dealer or MAXUS Website for further details.



Your local dealer



**HARRIS AUTOMOTIVE
DISTRIBUTORS U.C.**

FIND US @     

MAXUS Disclaimer:

Images shown in this brochure are for illustration purposes only. Actual vehicles may differ and are subject to change.

Specifications, standard equipment, options, fabrics and colours are subject to change without notice.

Some features may be unavailable when your vehicle is built. Some vehicles are pictured with options that may be available at extra cost or may not be available on certain models. Ask about availability of options and verify that the vehicle you ordered includes the equipment you ordered.

*5 year/125,000 mile warranty and 5 years roadside assistance. Terms and conditions apply.