

JAGUAR F-PACE







BY APPOINTMENT TO
HM THE QUEEN
MANUFACTURERS OF
MOTOR VEHICLES
JAGUAR LAND ROVER LIMITED
COVENTRY



BY APPOINTMENT TO
HRH THE DUKE OF EDINBURGH
MANUFACTURERS OF
MOTOR VEHICLES
JAGUAR LAND ROVER LIMITED
COVENTRY



BY APPOINTMENT TO
HRH THE PRINCE OF WALES
MANUFACTURERS OF
MOTOR VEHICLES
JAGUAR LAND ROVER LIMITED
COVENTRY



JAGUAR

THE ART OF PERFORMANCE

Every day we push performance to its limit. Our performance. Our cars' performance.
We innovate, we engineer, we design. We master rules and then break them.
Only to push further. Past the limits of convention. This is when performance becomes art.

Jaguar. The Art of Performance.





CONTENTS

INTRODUCTION

The Concept of F-PACE	06
F-PACE - The Facts	08

DESIGN

Exterior Principles	10
Exterior Detail	12
Interior Choice	15
Interior Space	18
Practicality	20

PERFORMANCE

Engines	22
Automatic Transmission	26
Manual Transmission	27
Advanced Aerodynamics	28
Lightweight Aluminium Architecture	31
Chassis and Suspension	32
Tested to the Extreme	34

DRIVING TECHNOLOGY

Advanced Driving Dynamics	37
Added Driver Confidence	38
Advanced Drivetrain Technology	41
Torque Vectoring	42
Stability and Control	45
Activity Key	47

TECHNOLOGY

Infotainment	49
Connectivity	50
Audio	54

SAFETY AND EFFICIENCY

Driver Assistance	56
Efficient Technologies	60

F-PACE SVR

The Concept of F-PACE SVR	63
Exterior	64
Interior	67
Performance	68
Configure Your F-PACE SVR	70

SPECIAL EDITIONS

New F-PACE Chequered Flag	74
New F-PACE 300 SPORT	76

PERSONALISATION

F-PACE - Your Choice	78
Choose your Engine	80
Choose your Model	82
Choose your Options	84
Choose your Colour	94
Choose your Wheels	96
Choose your Interior	98
Choose your Jaguar Gear - Accessories	110

THE WORLD OF JAGUAR

116

AT YOUR SERVICE

121

VEHICLE SHOWN: F-PACE S IN CAESIUM BLUE WITH OPTIONAL FEATURES FITTED

VEHICLES SHOWN ARE FROM THE JAGUAR GLOBAL RANGE. SPECIFICATIONS, OPTIONS AND AVAILABILITY WILL VARY BETWEEN MARKETS AND SHOULD BE VERIFIED WITH YOUR LOCAL JAGUAR RETAILER.

FITMENT AND AVAILABILITY OF FEATURES DESCRIBED MAY VARY BETWEEN ENGINES AND DERIVATIVES. PLEASE REFER TO THE SPECIFICATION AND PRICE GUIDE FOR DETAILS OR CONFIGURE YOUR VEHICLE AT JAGUAR.CO.UK

INTRODUCTION

THE CONCEPT OF F-PACE

F-PACE is inspired by the acclaimed C-X17 concept vehicle. It takes the pure Jaguar DNA of legendary performance, handling and luxury. Then it adds space and practicality.

The F-PACE range features an extended engine choice, including the 2.0 litre 4-cylinder 250PS Turbocharged Ingenium Petrol engine and the 2.0 litre 4-cylinder 240PS Turbocharged Ingenium Diesel engine. With advanced technology and all-aluminium construction, they are both optimised for a mix of economy and performance. Alternatively, choose the 2.0 litre 4-cylinder 163PS Turbocharged Ingenium Diesel engine for increased fuel efficiency.

F-PACE's bold personality can be accentuated with a choice of special editions. Chequered Flag lends itself to Jaguar's rich racing history, with assertive exterior styling and an interior derived from R-Sport. For eye-catching design that is sure to stand out from the crowd, 300 SPORT highlights F-PACE's sporting prowess. Its distinctive exterior accents complement unique interior detailing.

Please refer to the accompanying Technical Specification for full details on driveline, engine performance and fuel economy.

VEHICLE SHOWN: F-PACE S IN CAESIUM BLUE WITH OPTIONAL FEATURES FITTED

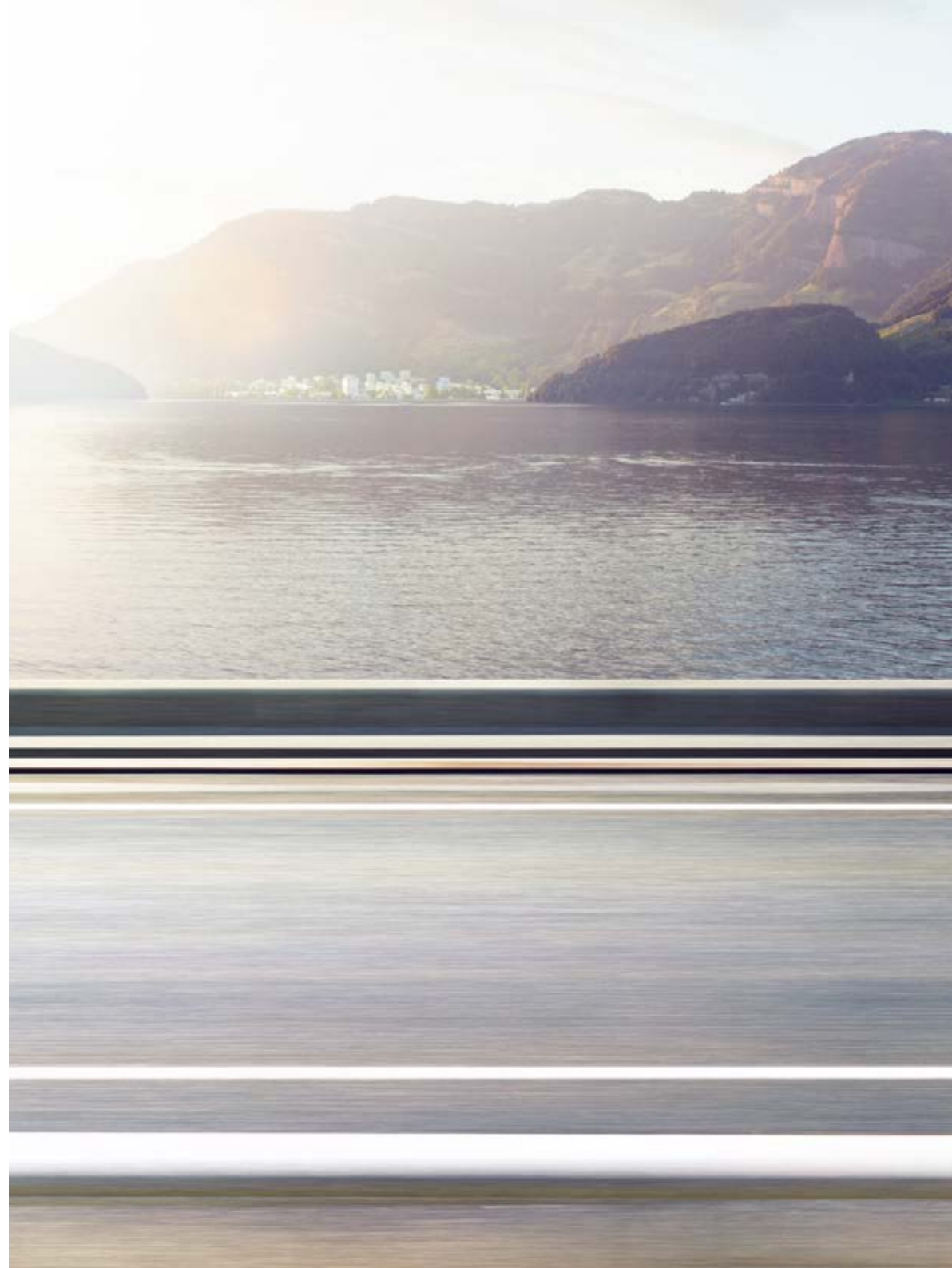



F-PACE - THE FACTS

Performance, handling and refinement. Practicality, capability and efficiency.

EFFICIENCY

Every F-PACE is designed and engineered for maximum efficiency. Low-friction technologies, a lightweight body structure and streamlined aerodynamics all contribute to enhanced fuel economy.

PRACTICALITY

F-PACE's rear knee and leg room is among the best in class and it has 40:20:40 seating configuration for greater flexibility. Loadspace is class-leading at up to 650 litres¹, with carefully considered dimensions designed to maximise its usability. With optional powered gesture tailgate² you can access the boot when your hands are full. Simply present your foot under either rear corner and the boot opens or closes.

CAPABILITY

F-PACE matches your practical driving needs and the demands of your lifestyle by offering the choice of either Rear Wheel Drive (RWD) or All Wheel Drive (AWD) for performance across an even wider range of conditions. Capabilities can be further enhanced by All Surface Progress Control (ASPC)³, a low-speed cruise control that helps F-PACE to cope with low-traction situations.

¹With Tyre Repair System. 508 litres with space saver spare wheel. 463 litres with full size spare wheel.

²Requires Keyless Entry.

³Standard on automatic transmission, not available on manual transmission.

Some features described here are optional.

Please refer to the accompanying Technical Specification for full details on driveline, engine performance and fuel economy.

VEHICLE SHOWN: F-PACE PORTFOLIO IN YULONG WHITE WITH OPTIONAL FEATURES AND RETAILER-FIT ACCESSORIES

PERFORMANCE

Discover exhilarating driving experiences across the entire F-PACE range. Our highly efficient performance engines offer a balance between economy and power. Engines include the 2.0 litre 4-cylinder 163PS Turbocharged Diesel – our most economical option from the Ingenium range – and the 3.0 litre V6 300PS Turbocharged Diesel, which is capable of reaching a limited top speed of 150mph with 0-60mph acceleration in 6.2 seconds.



REFINEMENT

Our cars have an unrivalled reputation for comfort and a smooth, quiet ride. Thanks to its stiff body structure, advanced suspension and aerodynamic design, F-PACE showcases Jaguar's supreme refinement.

HANDLING

F-PACE's advanced chassis and suspension system is an evolution of the configuration used on our F-TYPE sports car. This robust system is lightweight to ensure F-PACE delivers true sports handling. Jaguar's Electronic Power Assisted Steering (EPAS) software is specially tuned for optimum feedback and control, while the All Wheel Drive (AWD) system uses the F-TYPE-derived, unique Intelligent Driveline Dynamics (IDD) software for an agile feel and to minimise understeer. F-PACE always drives, feels and handles like a Jaguar.

DESIGN EXTERIOR PRINCIPLES

 F-TYPE INSPIRED STYLING | PURITY OF FORM

Visually inspired by F-TYPE, the Jaguar F-PACE is a performance SUV that has the DNA of a sports car. Its powerful, agile looks make it utterly distinctive and give it a head-turning road presence. From the bonnet bulge to the pronounced rear haunches, F-PACE reinvents the energy, strength and purity of form of F-TYPE.

VEHICLE SHOWN: F-PACE R-SPORT IN FIRENZE RED WITH OPTIONAL FEATURES AND RETAILER-FIT ACCESSORIES







EXTERIOR DETAIL

ADAPTIVE LED HEADLIGHTS*

Even at night, F-PACE is instantly recognisable thanks to its Adaptive LED headlights with signature DRL. Adding to F-PACE's commanding on-road presence, Adaptive LED headlights produce a colour of light that is close to daylight, helping your eyes to distinguish objects more easily. At the rear, full LED tail lights echo F-TYPE's distinctive design.

*Optional feature.

VEHICLE SHOWN: F-PACE S IN CAESIUM BLUE WITH OPTIONAL FEATURES FITTED







INTERIOR CHOICE



SPORTS COMMAND DRIVING POSITION

EXTENSIVE PERSONAL CHOICE

F-PACE's interior blends sportiness and elegance to create the latest in contemporary design. Our extensive range of premium materials, handpicked leathers and sophisticated finishes - including a Carbon Fibre trim finisher - gives F-PACE one of the most comprehensive interior choices in its class¹. This is your perfect opportunity to create a space that reflects your individual style.

Take personalisation to the next level with optional Configurable Ambient Interior Lighting. The system highlights the finest interior design details with soft pools of light in a choice of ten different colours. F-PACE can create an ambience to match your mood. F-PACE's modern interior design means essential controls are intuitive to use and always close at hand. A high centre console and the Sports Command Driving Position help the driver feel connected and secure. Slender roof pillars and a large windscreen mean all-round visibility is excellent. To add to the sports car feel, choose optional Performance seats² in perforated grained leather. Featuring adjustable side bolsters to hold you snugly in place, they offer even more lateral support - especially during enthusiastic driving.

The optional Cabin Air Ionisation with Nanoe™ technology improves the air quality within the vehicle's cabin and reduces allergens, viruses, airborne bacteria and associated odours. It does so by ionising particles in the air, making them attract to surfaces and thus helping to cleanse the air.

¹Compared to segment competitors.

²Only available on R-SPORT and S.

VEHICLE SHOWN: F-PACE PORTFOLIO WITH SIENA TAN PERFORATED WINDSOR LEATHER SEATS WITH SIENA TAN TONAL STITCH. OPTIONAL FEATURES FITTED







INTERIOR SPACE



PANORAMIC ROOF

OPTIMISED REAR SPACE

VEHICLE SHOWN PREVIOUS PAGE: F-PACE R-SPORT FEATURING EBONY/PIMENTO PERFORATED GRAINED LEATHER SPORT SEATS WITH PIMENTO CONTRAST STITCH. OPTIONAL FEATURES FITTED
VEHICLE SHOWN THIS PAGE: F-PACE PORTFOLIO FEATURING SIENA TAN PERFORATED WINDSOR LEATHER SEATS WITH SIENA TAN TONAL STITCH. OPTIONAL FEATURES FITTED



Choose one of our panoramic glass roofs to flood your F-PACE's interior with light and enhance the airy, spacious feeling. The fixed panoramic roof* brings the outside in by giving everyone superb views of the sky, whilst the optional sliding panoramic roof allows fresh air into the cabin whenever you want it. For greater privacy and to reduce excessive heating under intense sunlight, every panoramic roof is fitted with an electric blind as standard.

In the back, there's space for three adults to sit comfortably side by side. Rear leg and knee room are 944mm and 65mm respectively. Throughout the car you'll find neatly placed, versatile storage. There are useful pockets for smartphones and other small items either side of the centre console, as well as below the Touchscreen.

*Standard on Portfolio and optional on all other models.

40:20:40
DRY
385 Litres^{1,2} WET
650 Litres^{1,2}

PRACTICALITY

> CLASS-LEADING BOOT SPACE | **VERSATILE SEATING**

F-PACE has a class-leading boot capacity of up to 650 litres^{1,2}. The space is made even more versatile by the rear seats' 40:20:40 configuration. They can be folded completely, or folded individually, in a variety of combinations, to accommodate both passengers and awkward items such as skis. With the rear seats folded, F-PACE's total loadspace is up to an impressive 1,731 litres.

The parcel shelf, so often a difficult object to store, can be stowed under the loadspace floor³. The loadspace floor is reversible⁴ and can be switched, in an instant, from luxury carpet to an easy-clean, rubberised surface – perfect for damp or muddy equipment. Transferring items into and out of F-PACE is made easier by the low loading height and wide boot opening.

With optional powered gesture tailgate⁵ you don't even have to touch the car when your hands are full – simply present your foot under one of F-PACE's rear corners and the tailgate opens or closes.



¹When Tyre Repair System is fitted. Loadspace will vary depending on model and if full size or space saver spare wheel is fitted.

²Below the parcel shelf.

³On Portfolio and S when Tyre Repair System is fitted.

⁴Not available with full size spare wheel.

⁵Requires Keyless Entry.

Please consult your local Jaguar Retailer for further details.

VEHICLE SHOWN: F-PACE R-SPORT IN FIRENZE RED, FEATURING EBONY/PIMENTO PERFORATED GRAINED LEATHER SPORT SEATS WITH PIMENTO CONTRAST STITCH. OPTIONAL FEATURES FITTED

40:20:40
DRY 845 Litres¹ WET 1,200 Litres¹



40:20:40
DRY 994 Litres¹ WET 1,377 Litres¹



40:20:40
DRY 1,290 Litres¹ WET 1,731 Litres¹



¹Dry: Volume as measured with VDA-compliant solid blocks (200mm x 50mm x 100mm). Wet: Volume as measured by simulating the loadspace filled with liquid.

PERFORMANCE ENGINES



RESPONSIVE ENGINES

EFFICIENCY AND PERFORMANCE

Ingenium technology underpins three of the diesel engines in the F-PACE range. These low-friction, all-aluminium engines have stiff cylinder blocks and twin balancer shafts to ensure inherently low levels of vibration, for smooth day-to-day performance. All engines are equipped with Stop/Start technology and smart regenerative charging - harvesting kinetic energy from braking to charge the battery - for maximum economy, especially during urban driving. For information on driveline, engine performance and fuel economy, please refer to the accompanying Technical Specification.



INGENIUM DIESEL ENGINES UP TO 0-60mph in 6.8 seconds

The **Ingenium 2.0 litre 4-cylinder 163PS Turbocharged Diesel**¹ is refined and efficient. Low-flow direct injectors precisely control the amount of fuel that enters the combustion chamber for maximum efficiency. Intelligent, electronically controlled, adaptive engine cooling only engages when required – minimising fuel consumption and CO₂ emissions. This doesn't limit driving pleasure, the engine's strong torque gives good performance from low down in the rev range for brisk acceleration.

The **Ingenium 2.0 litre 4-cylinder 180PS Turbocharged Diesel**² offers performance and economy. For an engine of this size it offers high levels of torque, but not at the expense of efficiency – a balance achieved thanks to its variable geometry turbocharger. Adapting to the changing flow of exhaust gases, it maximises low-speed torque for broad power and responsiveness that is uniform, progressive and avoids lag.

The **Ingenium 2.0 litre 4-cylinder 240PS Twin Turbocharged Diesel**³ delivers high power and torque. Its series sequential twin turbocharger uses high and low pressure spools to give continuous acceleration and maximise performance. A higher specific power output is created by building on Ingenium technology. Upgrades include a higher pressure common rail fuel system, increased from 1,800 to 2,200 bar, and an improved fuel injector flow rate.

¹Only available on manual Rear Wheel Drive.

²Only available on automatic transmission.

³Only available on automatic All Wheel Drive.

Please refer to the accompanying Technical Specification for full details on driveline, engine performance and fuel economy.



DIESEL ENGINE

0-60mph in 6.2 seconds

The **3.0 litre V6 Twin Turbocharged Diesel engine**¹² offers exceptional power, torque and drivability. It uses innovative twin-parallel sequential turbocharging - a concept pioneered by Jaguar Land Rover - for smooth, more immediate delivery of power at all engine speeds, as well as two-stage water cooling to conserve energy.

F-PACE offers a choice of petrol engines – both of them are from our Ingenium range. With their lightweight, all-aluminium design, and widespread use of low-friction roller bearings, Ingenium Petrol engines are built for smooth, highly efficient performance. All engines are equipped with Stop/Start technology and smart regenerative charging – harvesting kinetic energy from braking to charge the battery – for maximum economy, especially during urban driving.



INGENIUM PETROL ENGINES UP TO

0-60mph in as little as 5.8 seconds

The **Ingenium 2.0 litre 4-cylinder 250PS Turbocharged Petrol engine**² delivers outstanding usable power and torque. For excellent acceleration and effortless overtaking, maximum torque is available between 1,300-4,500rpm. This engine's twin-scroll turbocharger is fed by an integrated exhaust manifold that synchronises exhaust pulses from two separate pairs of cylinders – significantly reducing turbo lag and improving engine response.

The **Ingenium 2.0 litre 4-cylinder 300PS Turbocharged Petrol engine's**² impressive power is balanced with strong fuel economy. For almost instant boost and high efficiency, its low inertia twin-scroll turbocharger features low-friction ball bearings and a high flow compressor wheel. Underpinned by the turbocharger's increased aerodynamic efficiency, the engine delivers rapid acceleration and maximum torque of 400Nm between 1,500-4,500rpm.

¹Only available on Portfolio and S.

²Only available on automatic All Wheel Drive.

Please refer to the accompanying Technical Specification for full details on driveline, engine performance and fuel economy.

AUTOMATIC TRANSMISSION

8-SPEED AUTOMATIC TRANSMISSION

F-PACE's automatic transmission is highly responsive, smooth and efficient. Developed specifically for the demands of a performance SUV, it delivers rapid shifting for effortless acceleration and overtaking. This intelligent, adaptive system subtly changes the way the throttle delivers power, as well as gearshift patterns, to suit your particular driving circumstances. The unique JaguarDrive Control system offers even quicker shifts and sportier kick-down in Dynamic Mode, and earlier up-shifts in Eco Mode to improve efficiency, while the Rain, Ice, Snow Mode enhances the vehicle stability in low-grip conditions by allowing for more gentle progress. The driver can also opt to manually control gearshifts via the steering wheel paddles at the touch of a finger.



MANUAL TRANSMISSION

6-SPEED MANUAL TRANSMISSION*

Choose the 6-speed Manual Transmission* for even greater driver involvement. This lightweight, highly advanced gearbox contributes to F-PACE's outstanding efficiency. Its aluminium alloy casing, hollow shafts and pocketed gears save every gram of weight possible. We use an advanced direct lubrication system to reduce friction and drag for greater efficiency and further weight-saving. Originally designed for the performance requirements of sports cars, F-PACE's outstanding 6-speed Manual Transmission delivers slick, short changes and superb levels of comfort.

*Only available on 2.0 litre 4-cylinder 163PS engine.





ADVANCED AERODYNAMICS

 **LOW DRAG** | **INCREASED STABILITY**

F-PACE's aerodynamic performance is a key function of its body design and supports an impressive drag coefficient from Cd 0.34*. The result is that F-PACE really is as sleek as it looks. Highly advanced aerodynamics reduce fuel consumption, CO₂ emissions and wind noise while adding to high-speed stability and driver confidence. F-PACE's innovative, lightweight underbody design is as important as the body you can see. The smooth underbody surfaces manage airflow to optimise cooling of the engine and brakes as well as helping to minimise drag, reduce turbulence and increase efficiency. As air reaches the back of F-PACE, the car's sharply angled rear corners and integrated spoiler limit pressure differences forming in the wake of the car for improved fuel economy.

*Engine and model dependent.

VEHICLE SHOWN: F-PACE PORTFOLIO IN YULONG WHITE WITH OPTIONAL FEATURES FITTED



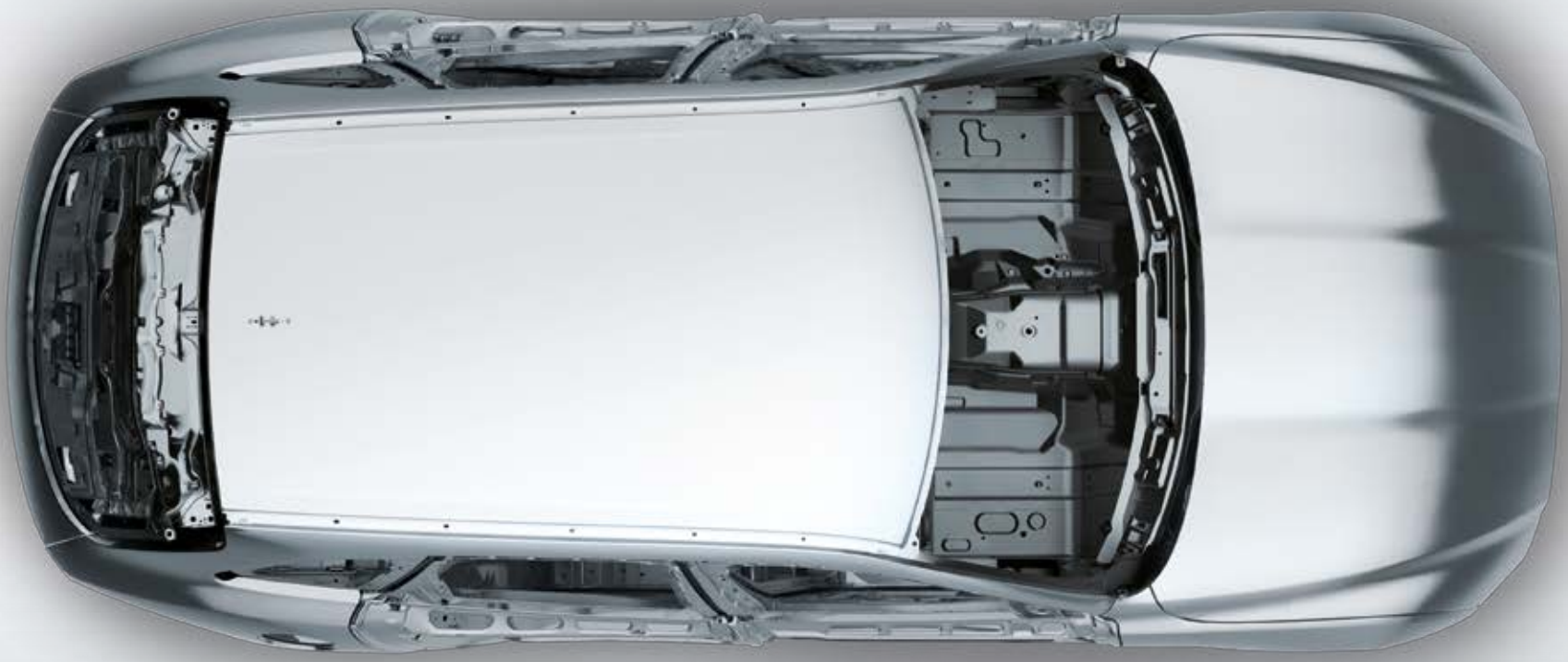

LIGHTWEIGHT ALUMINIUM ARCHITECTURE

 **STRONG** | **RIGID** | **80% ALUMINIUM¹**

Jaguar has been at the forefront of aluminium car construction for more than a decade. Our latest innovation is the Lightweight Aluminium Architecture that provides the foundations for F-PACE. We use aluminium where possible because it creates a stiff, strong and, most importantly, lighter architecture. The architecture's incredible strength offers excellent protection to all occupants, while its reduced weight enhances handling and braking. Aluminium has also been used to form the body sides, bonnet and front wings of F-PACE.

The use of aluminium enables F-PACE to be amongst the lightest cars in its class² - boosting efficiency from the outset. The reduced weight of F-PACE's structure is distributed with a near perfect 50:50 balance² for a sporting performance and an impeccable ride.

¹Aluminium content based on volume for body structure excluding doors, bonnet and tailgate.

²Model and engine dependent.

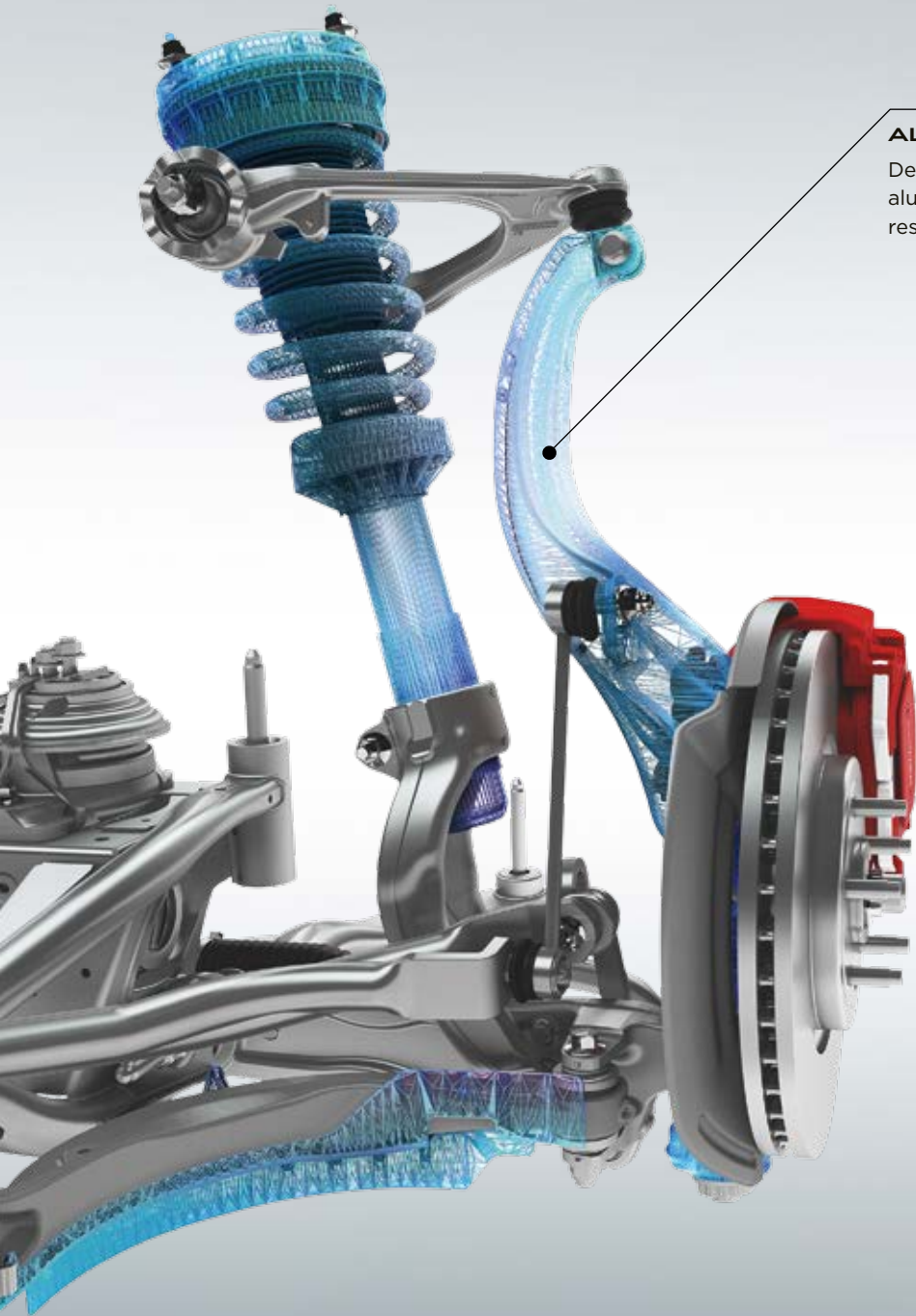

ALUMINIUM FRONT KNUCKLE

Designed to optimise stiffness and strength, the lightweight aluminium front knuckle helps improve F-PACE's agility, responsiveness and refinement for sports car-inspired control.

CHASSIS AND SUSPENSION



SUPERB RIDE
AND HANDLING

UNIQUE SUSPENSION
TECHNOLOGY

Underpinning F-PACE is an evolution of F-TYPE's chassis and suspension system – it offers a unique balance between agility and ride comfort. This ensures that F-PACE feels like a true Jaguar and is a pleasure to drive or be driven in. In combination with this suspension, F-PACE's stiff body structure and the use of lightweight acoustic damping materials create supreme refinement.

INTEGRAL LINK REAR SUSPENSION

Integral Link suspension allows F-PACE to realise a perfect combination of a refined, luxurious ride and sharp, responsive handling. The system separates and independently manages the lateral, longitudinal and vertical forces acting on the suspension for enhanced control and comfort. Many components are forged or hollow-cast in aluminium - the optimum production techniques for strong, lightweight suspension.

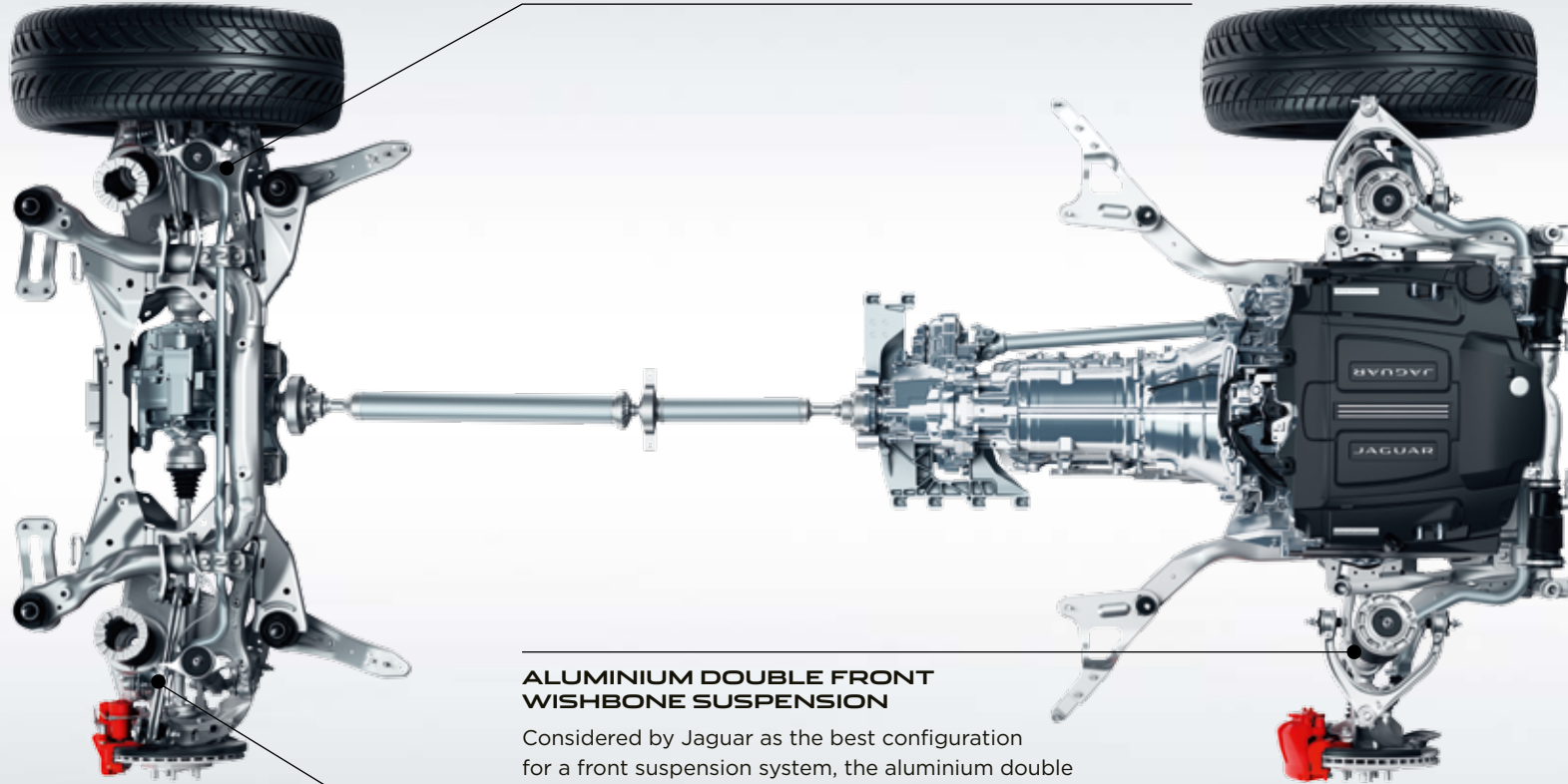

ALUMINIUM DOUBLE FRONT WISHBONE SUSPENSION

Considered by Jaguar as the best configuration for a front suspension system, the aluminium double wishbone design is modelled closely on F-TYPE's for precise handling and control.

ADAPTIVE DYNAMICS*

The Adaptive Dynamics system delivers both precise dynamics and a supple, luxurious ride by monitoring wheel position and body movements. The system constantly monitors conditions and adjusts the dampers to provide the optimum balance between comfort and refinement at all times.

*Standard on F-PACE S, optional on all other models with automatic transmission. Requires Configurable Dynamics.



SUSPENSION

We create unique algorithms to represent the strains and stress equivalent to 155,000 miles or ten years of driving on our state-of-the-art rig.



COLD CLIMATE

-40°C in our cold climate chamber ensures that when F-PACE is hard at work outside in freezing conditions, everything on the inside is working for your total comfort.



HOT TESTING

In the hot room, temperatures can soar up to 55°C. We can recreate wind speeds of up to 150mph and road speeds as high as 155mph. There's nowhere you can take F-PACE that it hasn't been already.

TESTED TO THE EXTREME



-40°C TO 55°C

FROM THE ARCTIC TO DUBAI

From the Arctic Circle and the mountains of China to the sands of Dubai and coast to coast in North America, F-PACE has seen almost everything the world's roads can throw at it. Then we brought F-PACE home to our UK testing facilities and things got really tough.



MONSOON TESTING

The monsoon chamber drenches F-PACE at every stage of the development process. We test for water management and dispersal along its body and over its windows. And we make sure that F-PACE stays dry inside as well as corrosion-free.



SEMI-ANECHOIC CHAMBER

Our 'neutral sound' room is where we make sure F-PACE sounds like a true Jaguar with its distinctive exhaust note.



FINAL INSPECTION

At the end of the production line every car is scrutinised by one of the most complex instruments in the world – the human eye. F-PACE undergoes an exhaustive visual inspection by expert quality inspectors.



DRIVING TECHNOLOGY

ADVANCED DRIVING DYNAMICS



MAXIMISING AGILITY

CONTINUOUSLY ADAPTING

Dynamic Mode revises the car's software to further enhance F-PACE's sporting character. It sharpens the throttle response, increases steering weighting and performs gearshifts more quickly¹ and at higher engine speeds. It also brings visual drama to the driver as the instrument cluster takes on a red glow. Dynamic Mode enhances your connection with F-PACE's inherent Jaguar performance.

ELECTRIC POWER ASSISTED STEERING

Electric Power Assisted Steering (EPAS) offers outstanding feedback, control and it is active on demand - saving power for where you really need it, as well as saving fuel. EPAS' sophisticated computer management varies steering assistance as appropriate - increasing assistance for low-speed manoeuvring and improving feel at higher speeds. It also enables advanced safety features such as Lane Keep Assist and Park Assist.

ADAPTIVE DYNAMICS^{2 3}

Whether you're accelerating on the motorway, cornering on country roads or navigating around town, optional Adaptive Dynamics modifies F-PACE's response to match the conditions and your driving style. It analyses acceleration, cornering, throttle and brake pedal activity, as well as kick-down activation. Steering movement is analysed up to 500 times a second and body movement up to 100 times a second. Electronically controlled dampers then constantly adjust to optimise the suspension settings and maintain F-PACE's dynamism and comfort.

CONFIGURABLE DYNAMICS²

Bringing technology from F-TYPE, the Configurable Dynamics system allows you to set up F-PACE's dynamics for throttle mapping, gearbox shift points and steering to suit your performance driving needs. When optional Adaptive Dynamics is fitted, you can make your setting even more personal by configuring the damper settings.

¹Automatic transmission only. ²Standard on F-PACE S, optional on all other models with automatic transmission. ³Requires Configurable Dynamics.

ADDED DRIVER CONFIDENCE



ALL SURFACE PROGRESS CONTROL¹

ADAPTIVE SURFACE RESPONSE^{1,2}

Unique in this class of car, Jaguar's All Surface Progress Control (ASPC) technology is a low-speed cruise control that helps F-PACE to cope with low-traction situations. ASPC allows the driver to concentrate on steering the vehicle. Once activated, you use the cruise control buttons to set a 'target' speed of between 2mph and 19mph. The system then works to achieve and maintain that speed while exerting optimum traction control.

ASPC is standard on all engines fitted with automatic transmissions and gives F-PACE drivers added confidence over slippery, loose or icy surfaces, undulating terrain and even while descending a difficult incline. It helps make F-PACE easy to drive in challenging conditions. ASPC also has a pull-away function, allowing F-PACE to progress from rest on low-grip surfaces and ascending gradients, as well as a Hill Descent Control function, which regulates vehicle speed on steeper inclines.

On All Wheel Drive (AWD) vehicles fitted with Adaptive Dynamics³, optional Adaptive Surface Response (AdSR) recognises differences between surfaces to exploit the maximum available grip. Drawing on Jaguar Land Rover's unrivalled expertise with All Wheel Drive (AWD) systems, AdSR constantly monitors the car's environment and adjusts the appropriate engine and brake settings. Once selected, AdSR works at all speeds to support you in adverse weather and across challenging surfaces.

¹Only available on automatic transmission.

²Only available on AWD.

³Standard on F-PACE S, optional on all other models with automatic transmission. Requires Configurable Dynamics.



GRAVEL



WET GRASS



SNOW/ICE



WET ROAD

DRY ROAD CONDITIONS

In normal conditions, torque is distributed to the rear wheels, delivering acclaimed Jaguar agility and handling.

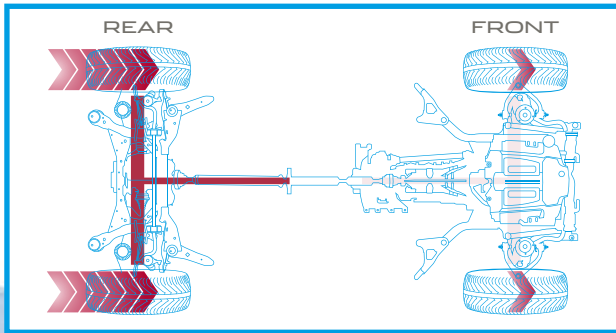

LOW-TRACTION CONDITIONS

On slippery surfaces, such as grass and snow, torque can be balanced between the front and rear wheels to maximise traction.

In extreme conditions where only the front wheels have traction, up to 100 percent of engine torque can be distributed to the front wheels for optimum grip.

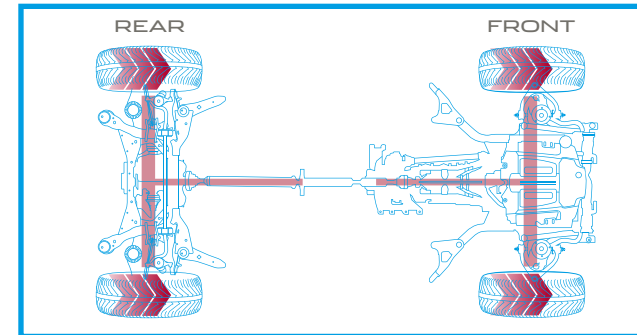

ADVANCED DRIVETRAIN TECHNOLOGY



ALL WHEEL DRIVE*

INTELLIGENT DRIVELINE DYNAMICS

F-PACE's All Wheel Drive (AWD) system combines the agility and character of Rear Wheel Drive (RWD) with the increased security and traction provided by AWD. In normal driving, F-PACE is predominantly RWD to deliver handling purity, feel and balance. But when roads become more challenging, or when you accelerate more keenly on low-grip surfaces, the system subtly channels power forwards, enabling F-PACE to maintain optimum traction for comfortable progress in all conditions.

F-PACE's AWD uses a transfer case at the back of the 8-speed Automatic Transmission to manage the appropriate distribution of torque to the front and rear wheels. Engineered to ensure that F-PACE retains the dynamic behaviour of a Jaguar, the transfer case contains an electro-mechanically activated multi-plate clutch with an actuator to build hydraulic pressure. This pressure is quickly and accurately controlled to generate the required force in the clutch to transfer the optimal amount of torque to the front wheels.

Unlike other systems that react to wheel slip, Jaguar's Intelligent Driveline Dynamics (IDD) software is predictive and uses sensors measuring throttle and steering inputs to anticipate wheel slip. IDD seamlessly co-ordinates these inputs and compares them with responses from the engine, transmission and traction control systems to calculate the traction available and distribute torque accordingly, even before grip is lost. From a standstill, F-PACE can transition from RWD to AWD in as little as 165 milliseconds or just 100 milliseconds when the car is moving.

The result is a drive which blends the character of RWD with the capability of AWD, providing outstanding levels of performance and control whatever the road throws at you.

*Not available on 2.0 litre 4-cylinder 163PS Diesel engine.

TORQUE VECTORING



MAXIMISED CORNERING CAPABILITY

F-PACE's Torque Vectoring by Braking (TVBB) maximises capability through even the tightest corners. Torque Vectoring technology provides controlled independent braking on the individual inside front and rear wheels to add to the turning forces acting on the car. In most conditions more braking pressure is applied to the rear inside wheel as this supports the most increased cornering capability, while the front inside wheel is braked for greater effectiveness and refinement. The result is reduced understeer for sharper turning and more consistent road holding. Torque Vectoring delivers increased sports car-like agility and added driver confidence.

ADDITIONAL ROTATIONAL FORCE
APPLIED AROUND VEHICLE'S AXIS

TORQUE VECTORING APPLIES
BRAKE PRESSURE TO SLOW
THE INSIDE FRONT AND INSIDE
REAR WHEELS INDEPENDENTLY

POWER IS SUSTAINED TO
MAINTAIN CONSTANT SPEED
OF OUTER DRIVEN WHEELS

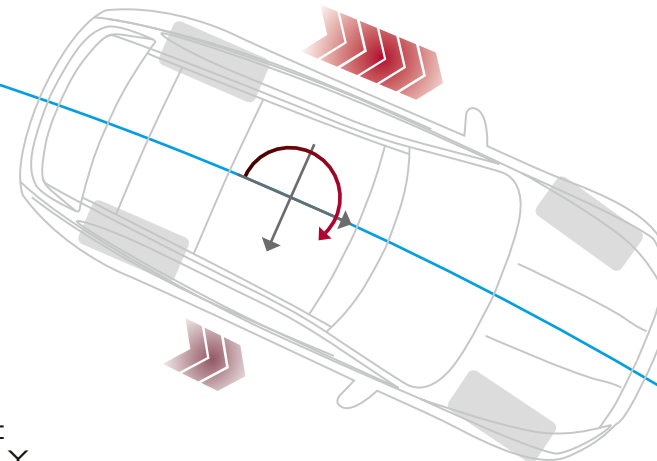

VEHICLE SHOWN: F-PACE R-SPORT IN FIRENZE RED WITH OPTIONAL FEATURES AND RETAILER-FIT ACCESSORIES







UNDERSTEER

OVERSTEER

BRAKING APPLIED TO APPROPRIATE WHEELS TO COUNTERACT UNDERSTEER/OVERSTEER

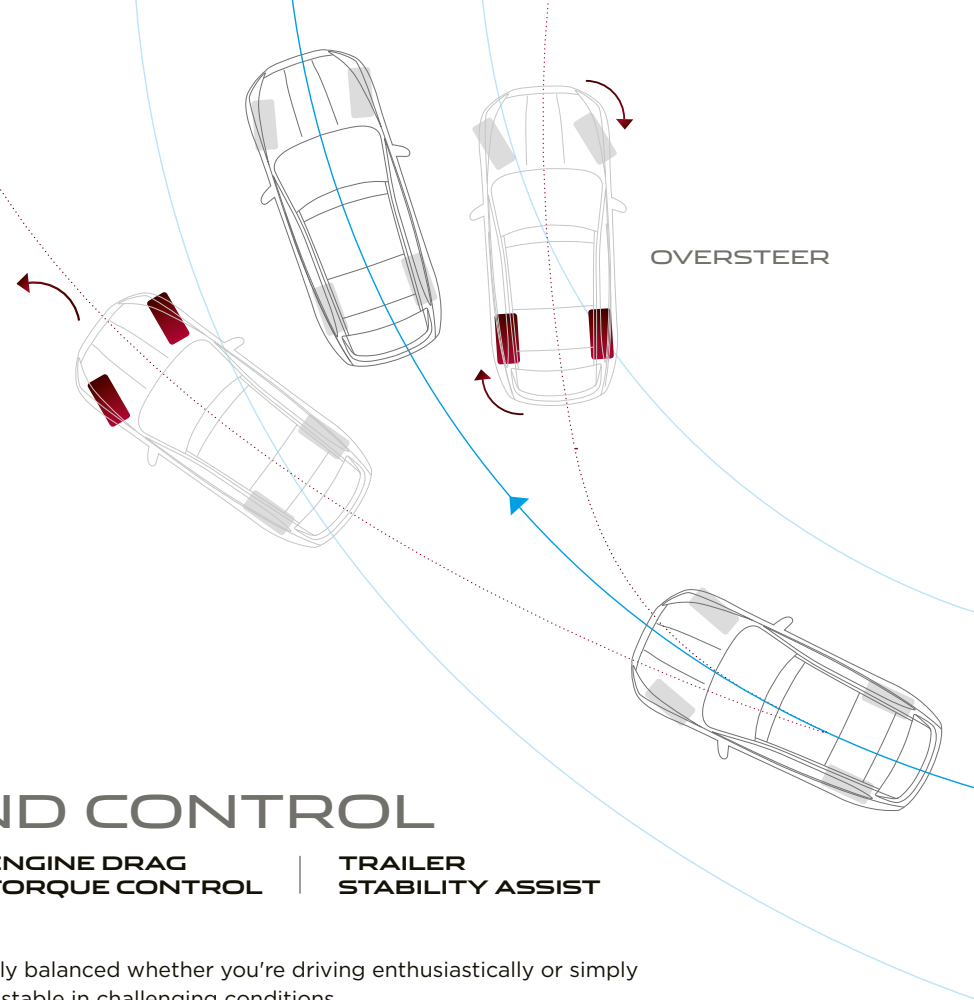

STABILITY AND CONTROL



DYNAMIC STABILITY CONTROL

ENGINE DRAG TORQUE CONTROL

TRAILER STABILITY ASSIST

Jaguar's stability systems keep F-PACE safely balanced whether you're driving enthusiastically or simply want the assurance of a car that will remain stable in challenging conditions.

Dynamic Stability Control (DSC) monitors F-PACE's dynamic behaviour, intervening to maximise vehicle stability and optimising available grip. DSC reduces engine torque and applies braking to the appropriate wheels to correct the car's direction of travel by counteracting understeer or oversteer. F-PACE's DSC system has enhanced understeer control to reduce speed and regain control more effectively.

Engine Drag Torque Control (EDC) mitigates the chance of wheel lock-up caused by strong engine braking in slippery conditions. It acts by briefly increasing torque to the wheels as appropriate.

Trailer Stability Assist (TSA) gives you greater stability when towing. Should TSA detect a dangerous trailer sway situation is developing, it can help you regain control by gradually reducing F-PACE's speed through lowering engine power and applying the brakes individually on each side of the vehicle to control the sway.

VEHICLE SHOWN: F-PACE R-SPORT IN FIRENZE RED WITH OPTIONAL FEATURES AND RETAILER-FIT ACCESSORIES





ACTIVITY KEY



ROBUST

WATERPROOF

SECURE

Activity Key* makes living life to the full even easier. For extra convenience, you can wear the Activity Key if you prefer not to carry a key fob. The wristband is robust and fully waterproof. It allows you to enjoy a range of activities - from skydiving to swimming - and keep your car key with you. You can use the Activity Key to lock and unlock your car. When exiting the car, you can leave the conventional key fob in the car and present the Activity Key to the tailgate to lock it. The conventional key fob is then automatically deactivated for security.

*Optional feature. Also available as a Jaguar Retailer fit accessory.



27°C



SET +
RES
CAN

HOME 2:56 PM
Navigation
Arlington Avenue
Learnington Spa
65km 4:55PM
Media
Bluetooth audio
Young Before Your Time
Corvidae
Phone
My iPhone

21.5 16.5
SYNC MAX A/C A/C AUTO

START STOP

TECHNOLOGY INFOTAINMENT

Delivering a wealth of information and entertainment, every F-PACE is equipped with our InControl infotainment system, Touch Pro. It features intuitive and advanced integrated technologies to ensure everyone can make the most of their journey.



10" TOUCH PRO

The standard 10" Touchscreen at the heart of the centre console supports swipe and pinch-to-zoom gestures and delivers our richest ever audio-visual entertainment. To enhance the in-car experience, Touch Pro offers customisable homescreens and fast response times, as well as voice control. Multi-tasking is also made easy thanks to the Interactive Side Panel. Touch Pro is further enhanced by the connectivity package, Connect Pro.



INTERACTIVE DRIVER DISPLAY

The optional 12.3" high-definition Interactive Driver Display can receive and project a vast amount of driving information, entertainment and active safety data including navigation, phone and media. Its high resolution ensures the utmost clarity and its refined processing engine delivers smooth-moving, pin-sharp graphics. To help you find your way more easily, Navigation Pro enables you to display full screen navigation with 3D mapping.



HEAD-UP DISPLAY

To help reduce distraction or the need for you to take your eyes off the road, Head-up Display is an option that presents key vehicle data such as your speed, gear position and navigation directions on the windscreen. It features crystal clear full-colour graphics in high resolution, enabling you to see all driver inputs and information with ease. It can display important information from the Touch Pro Touchscreen and your phone. The feature can be turned on and off dependent on driver preference.

Stay connected while on the move. Your new F-PACE will arrive with a SIM card equipped with an essential data plan of 500MB of data per month for the initial warranty period. You'll be better connected, receiving live traffic updates and more. Additional data can be purchased. Terms, conditions and restrictions apply. Contact your local Jaguar Retailer for more information.

InControl features, options and their availability remain market dependent - check with your Jaguar Retailer for local market availability and full terms. Information and images displayed in relation to the InControl technology, including screens or sequences, are subject to software updates, version control and other system/visual changes depending on options selected. Mobile network connectivity cannot be guaranteed in all locations. InControl Apps and Remote App will need to be downloaded from the Apple/Play Store. All in-car features should be used by drivers only when safe for them to do so. Drivers must ensure they are in full control of the vehicle at all times.

CONNECTIVITY

InControl is Jaguar's suite of features that connects you to your vehicle and links you seamlessly, and securely, with the outside world. There are a range of packs and options available to choose from. With a selection of apps, even when you're away from your car, some of the InControl features stay with you, making sure the Jaguar experience is more enjoyable than ever.

STANDARD FEATURES

PINPOINT TOUCH CONTROL

Pinpoint touch control allows you to interact with information swiftly. The Touchscreen responds in the same manner as a smartphone or tablet computer, providing multi-touch gestures such as pinch-to-zoom and swipe.

PERSONALISED HOMEPAGE

You can set up your homescreens the way you want them. With over 60 shortcuts and widgets, you can customise your system around the features you use most.

INTERACTIVE SIDE PANEL

A choice of side panels means you can multi-task. For example, your main screen area can be used for navigation, while the side panel provides phone controls. Simply swipe up and down to switch between multiple panels.

MULTIMEDIA

Enjoy a range of multimedia features on the Touchscreen. Connect your device and see details of playlists and music displayed by artist, album and genre.

ENHANCED PHONE INTERFACE

Making it easier and safer, you can call a favourite contact with a single touch. Additional functionality includes direct access to voicemail, conference calling and homescreen integration.

VOICE RECOGNITION SYSTEM

Understands clear spoken instructions, so you can concentrate on the road ahead without any distractions.



PROTECT

Jaguar Optimised Assistance¹ – If you break down, you can make a direct call to the Jaguar Assistance team by pressing the button on the overhead console or from the Assistance screen within the Remote smartphone app.

SOS Emergency Call – In a more serious incident, SOS Emergency Call will automatically connect you to the emergency response team who will notify the emergency services to your location. For peace of mind, this service is provided for the first ten years from date of registration.

Remote Essentials – Remote smartphone app provides information on your vehicle and enables you to interact with it remotely. Compatible with most smartphones, Android Wear™ or the Apple Watch®, this service includes:

- **Journey Tracking** – This opt-in feature can automatically record your journey history including your route and mileage statistics. This information can be exported by email to use for expense reporting and can be imported to a spreadsheet.
- **Vehicle Status Check** – Check current fuel level and range, and status of door and window position and locks. See the last parked location of the vehicle and find your way back to it with on-foot directions.

SMARTPHONE PACK²

By screen sharing with F-PACE's InControl infotainment system, the Smartphone Pack helps you stay connected to your smartphone even while in the car.

Android Auto™ was designed with safety in mind. With a simple and intuitive interface, it is designed to minimise distraction so that you can stay focused on the road. Simply connect your Android smartphone via a USB and control compatible apps on the in-car Touchscreen.

Apple CarPlay® is also designed for increased safety, enabling the use of apps while allowing the driver to concentrate on the road ahead. Connect your Apple smartphone to your car to use compatible apps such as maps, messages and music through the Touchscreen.

¹Jaguar Optimised Assistance is a subscription service that can be extended after the initial term advised by your Jaguar Retailer.

²Features within Smartphone Pack may vary between markets.

iPhone is a registered trademark of Apple Inc., registered in the US and other countries. Please ensure iPhone compatibility is reviewed with your local Jaguar Retailer.

Android™ is a trademark of Google LLC.

NAVIGATION PRO

Navigation Pro allows you to save your favourite places, use swipe and pinch-to-zoom gestures for simple map exploration and display a choice of either 2D or 3D crystal clear map graphics. It includes Traffic Sign Recognition and Adaptive Speed Limiter.

INCONTROL APPS

Jaguar InControl Apps technology allows vehicle-optimised apps on your Android™ or Apple® smartphone to be controlled through the vehicle's Touchscreen, including contacts, calendar and music player via a USB cable. You can also download third-party apps offering a range of services.

- **Spotify¹** – Access a library of more than 30 million songs with this seamlessly integrated app. Featuring all the same intuitive functionality as the Spotify smartphone app, you can search songs, stations and recommendations, create playlists and access your music in offline mode. Simply log in using your existing Spotify Free or Spotify Premium account.
- **Tile²** – Helps you find lost or misplaced items in seconds. Attach a tiny Bluetooth tracker Tile to your keys, wallet or bag. The easy-to-use Tile app can then help you find these items should they be misplaced. The app is accessible any time through your vehicle's Touchscreen, allowing you to make sure you have everything you need with you, before you set off on your journey.

REMOTE

Remote Premium provides the following enhancements to the Remote Essentials smartphone app:

- **Remote Lock/Unlock** – Lock or unlock your doors remotely with the click of a button. Simply press the 'lock' button on the Vehicle Security screen of the Remote smartphone app to single lock the doors, arm the alarm, fold in the door mirrors³ and close the windows. Press the 'unlock' button to unfold the door mirrors³, turn on the dipped headlights and cause the hazard lights to flash twice.
- **Remote Climate⁴** – Prepare your F-PACE in advance by pre-heating or pre-cooling the cabin, so that you and your passengers are comfortable from the moment you step inside.
- **Beep/Flash** – This feature turns on your Jaguar's hazard lights and dipped headlights, and sounds an audible alert to help you locate your vehicle in a crowded car park.

4G Wi-Fi

The 4G Wi-Fi Hotspot provides in-car access to the Internet, enabling up to eight wireless devices to be used simultaneously in the car. Passengers can connect through the vehicle's wireless network to surf, work, update social media and stay entertained throughout the journey.

PRO SERVICES

- **Real Time Traffic Information** – Uses live traffic data feeds to give you the most accurate picture of what the traffic is like on the way to your destination.
- **One-box Search** – Wherever you are, you can search the surrounding area for places of interest. The system can access expert destination information, travel tips and inspiration as well as online travel reviews of the local area.
- **Planning Routes and Door-to-Door Routing** – Before setting off, use the Route Planner app or online portal to search, save locations or set your destination. The app uses the Cloud to send your destination automatically to your vehicle's navigation screen. Once you've parked, the Route Planner app will guide you to your destination – a true door-to-door experience which includes public transport options.
- **Share ETA** – You can share your estimated time of arrival so your selected contact(s) will know exactly when you will arrive, as calculated by the navigation guidance system. If you're running late, Share ETA can then send automatic updates via text messages or email, without any further action from you.
- **Satellite View** – When you want to get the context of your surroundings from overhead, simply switch to satellite view.
- **Commute Mode** – Allows the system to learn your commutes and automatically advises you of the expected journey time based on live and historical traffic movements, without you having to input a destination. The system learns the routes you take for a given destination and then advises which of those is the quickest. The feature can be turned on and off dependent on driver preference.
- **Parking Service** – As you approach your destination, you can see where parking is available. Simply tap on your preferred car park and the navigation system updates to direct you to it.

¹Please check App Store and Google Play for availability. ²Bluetooth tracker tiles must be purchased separately. 2016 Tile Inc. and the Tile design are trademarks of Tile, Inc.

³When auto-dimming, power fold, heated door mirrors are fitted. ⁴Only available on automatic transmission. ⁵Secure Tracker will require further subscription after the initial term.

Remote contains subscription services that can be extended after the initial term advised by your Jaguar Retailer. Stay connected while on the move. Your new F-PACE will arrive with a SIM card equipped with an essential data plan of 500MB of data per month for the initial warranty period. You'll be better connected, receiving live traffic updates and more. Additional data can be purchased. Terms, conditions and restrictions apply. Contact your local Jaguar Retailer for more information. InControl features, options and their availability remain market dependent – check with your Jaguar Retailer for local market availability and full terms. Information and images displayed in relation to the InControl technology, including screens or sequences, are subject to software updates, version control and other system/visual changes depending on options selected. Mobile network connectivity cannot be guaranteed in all locations. InControl Apps and Remote App will need to be downloaded from the Apple/Play Store. All in-car features should be used by drivers only when safe for them to do so. Drivers must ensure they are in full control of the vehicle at all times.

- **Online Routing** - While you're on your way to a destination, the system monitors live traffic conditions and takes into account typical traffic patterns for that time of day, keeping you on the optimum route.
- **Safety Cameras** - Alerts you to the location of accident black spots monitored by safety cameras.
- **Fuel Prices** - When you're going to fill up, the Fuel Price service not only finds filling stations along your route, it also enables you to compare fuel prices so you can keep your costs down.
- **Online Media** - Allows for the aggregation of numerous content providers and their personalised content - such as Deezer and Tuneln - that gives access to more than 40 million music tracks and four million on-demand programmes and podcasts. For the first time, these can be directly streamed from the vehicle without the need for a smartphone - providing a seamless and integrated experience.

androidauto



tile

OPTIONAL FEATURE

SECURE TRACKER⁵

Uses tracking technology to alert you to an attempted theft, and signals your vehicle's location to the relevant authorities, for a timely recovery.



AUDIO

A vehicle's cabin is the ideal place within which to experience your personal choice of music and Jaguar F-PACE has the option of three different audio systems to bring your music to life:



SOUND SYSTEM

Excellent acoustic range through six speakers.

MERIDIAN™ SOUND SYSTEM¹

Great definition, crystal clear highs and full, deep bass – delivered through the careful arrangement of ten speakers and a dual channel subwoofer.

MERIDIAN SURROUND SOUND SYSTEM²

All the fullness and clarity of a live performance delivered through an arrangement of 16 front, side and rear speakers and a dual channel subwoofer – seamlessly brought together using Trifield™ technology. Exclusive to Meridian, Trifield perfectly blends the centre and surround channels with left and right channels ensuring an optimum, consistent sound experience for each passenger.

DIGITAL AUDIO BROADCAST (DAB) RADIO







DAB radio technology offers improved sound quality, a wide choice of stations and live text information about the station, show and song you are listening to.

¹Standard on Portfolio and S, optional on all other models. ²Optional on all models.

Image is representative of Meridian Surround Sound System

MERIDIAN™

Formed in 1977 in Cambridgeshire, England, Jaguar’s audio partner Meridian has pioneered many firsts including active speakers and the world’s first digital surround sound processor. Meridian’s audio technology input has helped ensure that Jaguar F-PACE is the most superb space within which to experience sound. Meridian Cabin Correction technology was utilised to analyse cabin shape, acoustics and resonance characteristics in order to help remove unwanted sounds. The advanced algorithm ensures that the rhythm, punch and timing of any piece of music are heard precisely how the artist intended, providing a consistently exceptional quality audio experience for all passengers in the vehicle.

	UNIQUE MERIDIAN TECHNOLOGY	SPEAKERS + SUBWOOFERS	WATTS
SOUND SYSTEM	N/A	6	180
MERIDIAN™ SOUND SYSTEM	  	10 + 1	380
MERIDIAN™ SURROUND SOUND SYSTEM	   	16 + 1	825



DIGITAL SIGNAL PROCESSING

Brings all elements of the audio system together as one, for performance that would otherwise require significantly larger speakers.



MERIDIAN CABIN CORRECTION

The advanced algorithm of Meridian’s Cabin Correction tailors the sound experience to the precise acoustics of F-PACE’s interior.



MERIDIAN DIGITAL DITHER SHAPING

To maintain the quality of musical recordings, they are converted into a common digital format. Meridian Digital Dither Shaping ensures that digital signal conversions are made smoothly and seamlessly, preserving the finest details of the audio performance. The result is authentic musical conversion, evoking the emotions of the original recording.



TRIFIELD™

Exclusive to Meridian, Trifield blends the centre and surround channels seamlessly with left and right channels, delivering a consistent, concert-like experience for all occupants.

Meridian is a registered trademark of Meridian Audio Ltd.
Trifield and the "three fields" device is a trademark of Trifield Productions Ltd.
Features and their availability may differ by vehicle specification and market.

SAFETY AND EFFICIENCY DRIVER ASSISTANCE

MAKING DRIVING EASIER AND SAFER

From negotiating city traffic or the motorway, to providing additional safety for you and your passengers, there's a wealth of innovative technologies available, either as standard, optional or as part of an optional pack. Whichever you choose, you'll find every single feature has been designed and engineered to heighten your enjoyment of the vehicle.

STANDARD FEATURES

Front and Rear Parking Aids make manoeuvring even easier. Sensors located in the front and rear bumpers are activated manually, or when reverse is selected. As you park, the Touchscreen display and audio feedback indicate how close you are to obstacles.

Emergency Braking can help to prevent collisions with other vehicles, as well as pedestrians. If a potential frontal collision is detected, a warning is displayed, giving you time to take action. A camera at the front of the vehicle monitors at speeds from 3mph to 50mph for frontal collisions, and 3mph to 37mph for pedestrians. If a collision is still anticipated and you have taken no action, this system will apply the brakes to help reduce the severity of the possible impact.

Cruise Control and Speed Limiter allows the driver to maintain the current speed of the vehicle without the need for continued use of the accelerator pedal, helping to reduce driver fatigue. In addition, the Speed Limiter will also allow the driver to pre-set a maximum specified speed which the vehicle will not exceed. Both functions can be easily turned on or off by the driver as desired.

Driver Condition Monitor detects if you're starting to feel drowsy by monitoring steering inputs, brake and throttle pedal activity to give you an early warning when you need to take a break.

Lane Keep Assist detects when the vehicle is unintentionally drifting out of the lane and applies a corrective torque to the steering wheel, encouraging you to guide your vehicle back.

Rear Camera provides improved visibility when reversing. Static lines representing the vehicle's outer perimeter and predicted path are superimposed on the rearward image displayed on your Touchscreen.

Traffic Sign Recognition: included in Navigation Pro, Traffic Sign Recognition keeps you informed and aware on the road, by displaying speed limits and 'no overtaking' signs in the instrument cluster, where they can easily be seen. Adaptive Speed Limiter uses Traffic Sign Recognition information to adjust your vehicle's speed accordingly by using the cruise control system.

OPTIONAL FEATURES

360° Surround Camera¹ uses four digital cameras discretely placed around the vehicle, providing a 360° overhead view on the Touchscreen. With the capacity to display several different views at the same time, this helps with various manoeuvres from parking by a kerb, to getting in and out of tight spaces and junctions.

Blind Spot Assist^{1,2} can help you prevent collisions. If your vehicle detects another car in your blind spot when you begin to change lanes, a small warning light illuminates in the corresponding door mirror. Corrective torque is also applied to the steering wheel, encouraging you to guide your vehicle away from the approaching vehicle.

¹Only available when auto-dimming, power fold, heated door mirrors are fitted.

²Automatic transmission only.

³Not available with Driver Assist Pack.



Park Assist



Adaptive Cruise Control

OPTIONAL PACKS

PARK PACK³

Park Pack enables you to park and manoeuvre safely and securely in and out of tight spaces and into traffic that is obscured by buildings or other vehicles. It features:

Park Assist makes parallel and perpendicular parking easier than ever by steering your vehicle into a suitable space. Selecting the appropriate gear, you only have to control the vehicle's speed with the brake and accelerator pedals. Steering will be done automatically by the car. Graphics and notifications guide you through the manoeuvres. Park Assist will also steer you out of a space, taking all of the stress out of parking.

360° Parking Aid gives you complete confidence when manoeuvring in tight spaces. Sensors located around the car are automatically triggered when Reverse is selected, or can be manually activated, with a graphic appearing on the Touchscreen showing an overhead view of the vehicle. As you park, the Touchscreen display and audio feedback indicate how close you are to obstacles.

Rear Traffic Monitor is particularly useful when reversing out of a parking bay. The system warns you of vehicles, pedestrians or other hazards approaching from either side of your vehicle. It will alert you with both audio and visual warnings so you know what's behind you even when the view is obstructed.

DRIVE PACK¹²³

Making every journey safer and more relaxing. The Drive Pack includes:

Adaptive Cruise Control will help keep your vehicle a safe distance from the one in front should it slow or stop when you're cruising on the motorway or travelling in slow-moving traffic. Should the vehicle in front stop completely, your vehicle will come to a smooth halt. In stop-start traffic, Adaptive Cruise Control will automatically resume following the car in front. The system can be activated from 12mph and once activated will operate between 0-124mph.

High-speed Emergency Braking detects when a potential frontal collision with another vehicle may occur and displays a forward alert to warn the driver to brake. If the driver doesn't react, the car will deploy the brakes in order to reduce the severity of the possible impact. High-speed Emergency Braking is ready and active from 6mph to 99mph.

Blind Spot Assist can help you prevent collisions. If your vehicle detects another car in your blind spot when you begin to change lanes, a small warning light illuminates in the corresponding door mirror. Corrective torque is also applied to the steering wheel, encouraging you to guide your vehicle away from the approaching vehicle.

OPTIONAL PACKS

DRIVER ASSIST PACK¹²³

The Driver Assist Pack offers a wide range of driver aids including the features found in both the Park Pack and Drive Pack (see page 57) together with 360° Surround Camera. It also includes new Adaptive Cruise Control with Steering Assist which centres the vehicle in lane and maintains a set distance from vehicles ahead, making driving even easier and more comfortable.

¹Automatic transmission only.

²Only available when auto-dimming, power fold, heated door mirrors are fitted.

³Not available with Park Pack or Drive Pack.



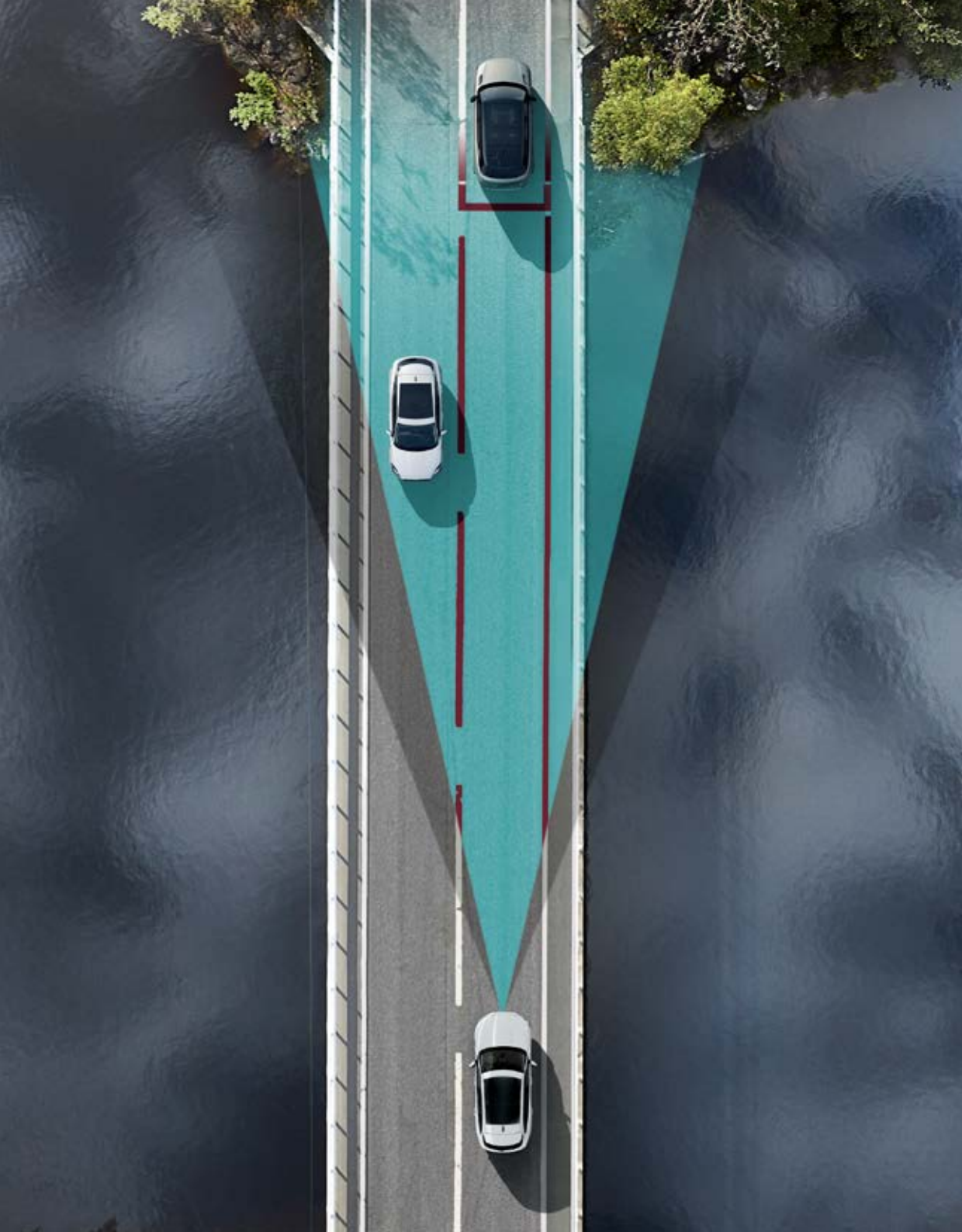

Adaptive Cruise Control with Steering Assist works with you, assisting with steering, braking and acceleration as you keep your hands on the wheel and anticipate the road ahead. A camera and radar then work together to track vehicles and lanes ahead to maintain a central position for your vehicle, and moderate its speed according to the behaviour of the traffic in front of you. If the vehicle ahead slows, even to a standstill, the feature automatically slows your vehicle, bringing it to a stop where necessary to maintain a relaxed and composed drive in busy traffic situations.

Should you remove your hands from the wheel, the vehicle will provide a warning. If the warning is not heeded then the Steering Assist is deactivated but the Adaptive Cruise Control will remain active.



FRONT CAMERA



FRONT RADAR

EFFICIENT TECHNOLOGIES

ADVANCED AERODYNAMICS

F-PACE's aerodynamics are developed and optimised with the aid of Computational Fluid Dynamics analysis. The management of airflow and drag not only add to F-PACE's high-speed stability, but also improve its fuel economy*.

LIGHTWEIGHT MATERIALS

At every stage of the development process, engineers maximised weight saving across all the car's elements. This produces an optimum balance between best performance and weight saving for greater efficiency.

STOP/START

All F-PACE's engines are available with Stop/Start. It shuts down the engine when you come to a complete halt and restarts the engine immediately when required. Helping to save fuel, especially during urban driving.

ECO MODE

Eco Mode encourages fuel-efficient driving by reducing throttle sensitivity, selecting more economical engine mapping and, on manual vehicles, advising of gear shifts. It also reduces fuel consumption by minimising the energy demands placed on the engine by climate control and audio systems. A display on the Touchscreen helps you by providing vehicle data and driving tips.

SUSTAINABLE CONSTRUCTION

The aluminium alloy used for much of F-PACE's construction is from a high level of recycled aluminium. Using significantly less energy than primary aluminium to produce, it minimises F-PACE's environmental impact.

ADBLUE®

F-PACE's diesel models are fitted with AdBlue to help clean exhaust gases. AdBlue is a non-toxic, non-flammable, biodegradable additive that cleanses the gases in the car's exhaust system to remove harmful nitrogen oxide emissions.

LOW-FRICTION TECHNOLOGIES

The Ingenium engine range uses smart coating technologies on pistons, needle roller bearings and other mechanical parts. This helps to reduce friction, especially at low engine temperatures, so the car performs at its best and most efficient.

*Please refer to the accompanying Technical Specification for full details on driveline, engine performance and fuel economy.

VEHICLE SHOWN: F-PACE R-SPORT IN FIRENZE RED WITH OPTIONAL FEATURES AND RETAILER-FIT ACCESSORIES





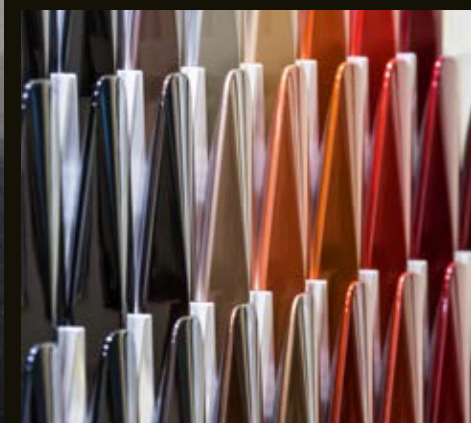

F-PACE SVR

THE CONCEPT OF F-PACE SVR

F-PACE SVR is the most significant evolution yet of the award-winning F-PACE. It's an SUV with the DNA of a sports car. A sports car with all the practicality of an SUV. SVO's highly skilled Engineers and Aerodynamics Experts have analysed and tested every force acting on every part of the vehicle, in every way possible. Then, armed with this information, new heights of precision engineering were achieved to result in something truly special.

Knowledge is more than power, it's also essential in tuning aerodynamics. Our Engineers have shaped acting forces in order to deliver breathtaking performance; a full-size SUV that can roar to 60mph in a thrilling 4.1 seconds.



EXTERIOR

Designed for uncompromised performance, no single part of F-PACE SVR exists for aesthetics alone. A revised front end with enlarged air intakes and optimally positioned bonnet vents are there to maximise airflow and cooling. They also give F-PACE SVR an aggressive stance and hint towards the enormous power within.

New 395mm front brakes and 396mm rear brakes, with Red 4-piston front brake calipers, deliver outstanding braking performance. Bolder wheel arches house 21" or optional 22" forged alloy wheels. For increased grip and improved cornering capability, 295mm wide rear tyres further underscore F-PACE SVR's sporting prowess.

A new spoiler extends the roofline, offering substantial lift reduction and high-speed stability; a highlight of F-PACE SVR's sports car pedigree. For eye-catching styling, and performance you can hear, the F-TYPE inspired Switchable Active Sports Exhaust system features quad tailpipes in highly polished aluminium. Make all this yours with the art of personalisation, which includes the choice of a range of striking exterior colours for F-PACE SVR, including Indus Silver and Ultra Blue.







INTERIOR

Whether you're sitting in the front or the back, you connect with F-PACE SVR from the moment you slide into the form-hugging Performance seats. The 14-way slimline front seats with memory, climate control and SVR embossing feature a lozenge pattern in Premium perforated leather. Adding to the sports car feel, side bolsters hold you snugly in place when cornering. In the rear, matching perforated leather Performance seats offer even more lateral support than in the standard F-PACE - especially during enthusiastic driving.

The 3-spoke sport steering wheel is wrapped in leather with a contrasting baseball stitch and SVR badging. The SportShift Selector, a detail inspired by F-TYPE, is simple and intuitive to use. For fast, manual changes, without the need for the driver to take their hands off the wheel, gear changes can also be made using the aluminium gearshift paddles. For a strikingly different look, choose from four high-impact interior colour combinations to create your perfect F-PACE SVR.



PERFORMANCE

Here are some figures to set your pulse racing, before you even get inside the car. F-PACE SVR's 5.0 litre V8 Supercharged Petrol engine delivers an astonishing 550PS and 680Nm of torque. It accelerates from 0-60mph in just 4.1 seconds, on its way to a top speed of 176mph.

Jaguar's 8-speed Automatic Transmission has been specifically tuned by Special Vehicle Operations – this system combines precise shifting with an exceptionally rapid response. Eight closely spaced ratios provide strong acceleration, with each shift completed in just 200 milliseconds. F-PACE SVR's bespoke aerodynamics allow this raw power to be released completely unhindered as it slices through the air, creating a thrilling drive without compromise.

Throttle response has been optimised for improved feedback, while a final drive ratio delivers a precise driving experience. Jaguar's advanced torque-on-demand All Wheel Drive system dispatches torque to the wheels that have most traction – delivering maximum grip and control for confident handling in all weathers, on all surfaces.

The Switchable Active Sports Exhaust system reacts to throttle position, speed and engine revs by opening a set of active valves. This allows exhaust gases to take a more direct route through the rear silencer, producing a much richer, more exhilarating sound.



CONFIGURE YOUR F-PACE SVR

CHOOSE YOUR EXTERIOR

This is where you really make it your F-PACE SVR. Select the body colour, roof style and exterior options that suit you, then choose the perfect wheels to complement them.

CHOOSE YOUR ROOF



Body-coloured roof



Sliding panoramic roof



Fixed panoramic roof

CHOOSE YOUR WHEELS



21" Style 5080, 5 split-spoke,
Satin Technical Grey with
contrast Diamond Turned finish



22" Style 5081, 5 split-spoke,
Gloss Black



22" Style 5081, 5 split-spoke,
Satin Technical Grey with
contrast Diamond Turned finish

CHOOSE YOUR COLOUR

Fuji White

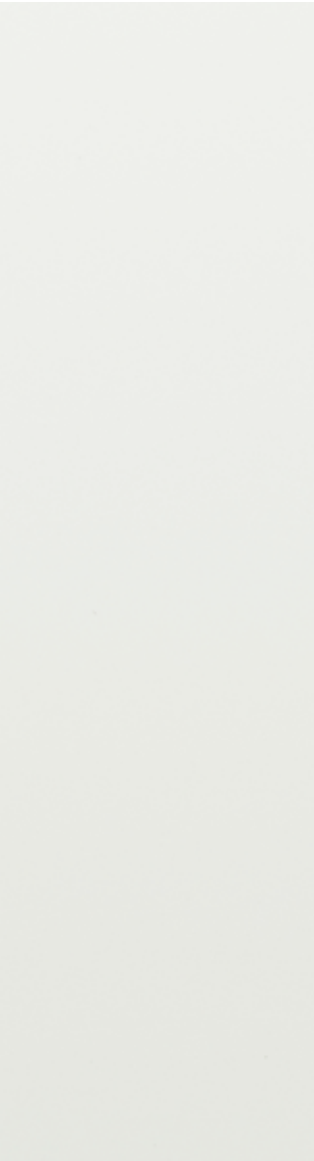

Santorini Black



Yulong White



Eiger Grey



Indus Silver

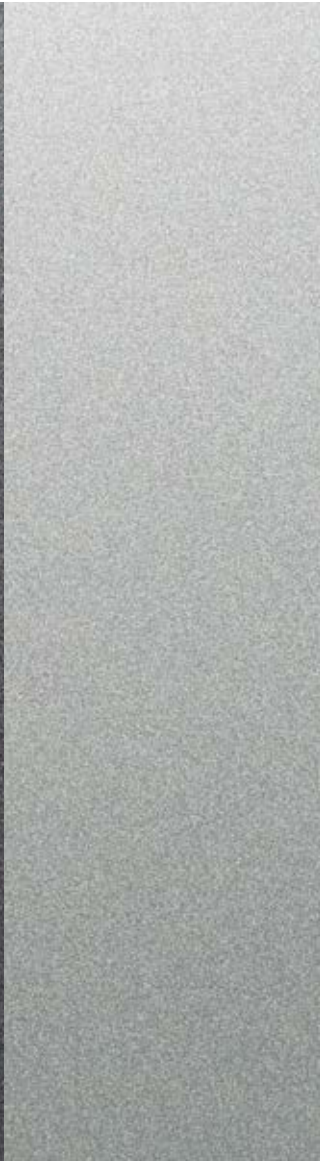

Ultra Blue



Firenze Red



CHOOSE YOUR INTERIOR

Select your interior colourway and then choose from a range of options and Jaguar Gear choices.

YOUR SEAT STYLE AND MATERIAL



Perforated Windsor leather seats with SVR pattern and embossing



CHOOSE YOUR INTERIOR COLOURWAY



Ebony/Pimento



Ebony/Light Oyster



Ebony/Siena Tan

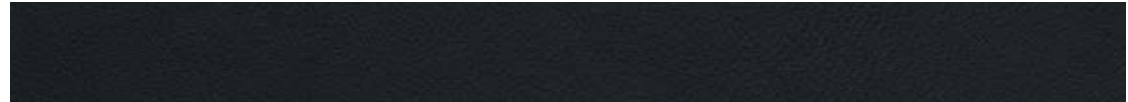

Ebony/Ebony

CHOOSE YOUR TRIM FINISHER



Meshed Aluminium trim finisher



Aluminium Weave Carbon Fibre trim finisher

YOUR HEADLINING



Ebony suedecloth

F-PACE SVR UNIQUE FEATURES

EXTERIOR FEATURES

SVR badge
Dark Satin Grey front fender grille
Gloss Black grille with Satin Grey surround
Dark Satin Grey bonnet louvres
Quad tailpipes with 95mm finishers

WHEELS

21" Style 5080, 5 split-spoke, Satin Technical Grey with contrast Diamond Turned finish

INTERIOR FEATURES

SportShift Selector

SEATING AND INTERIOR TRIM

Perforated Windsor leather seats with SVR pattern
Front headrests with SVR embossing
SVR branded heated leather steering wheel
SVR premium carpet mats
Metal treadplates with SVR branding

DYNAMICS

Switchable Active Sports Exhaust
Electronic Active Differential



NEW F-PACE CHEQUERED FLAG

F-PACE Chequered Flag captures the essence behind Jaguar's signature characteristics. Starting at its front profile, a performance-focused S front bumper with body-coloured cheeks adds a sporting emphasis to the air intakes. Then, to amplify its all-round muscular form, F-PACE Chequered Flag has been equipped with full Black Pack – a suite of Gloss Black-finished exterior features. This includes the side window surrounds, grille surround, door cladding, and the exclusive Chequered Flag badged side vents, distinguishing its individuality. Assertive styling underpins this edition, continuing inside with an R-Sport leather interior focused around the driver. Choose between two impressive colour options: Ebony and Pimento, or Ebony with a Light Oyster contrast stitch.

Features:

Available with Ingenium 2.0 litre 4-cylinder 180PS AWD Turbocharged Diesel, Ingenium 2.0 litre 4-cylinder 240PS AWD Twin Turbocharged Diesel, or Ingenium 2.0 litre 4-cylinder 250PS AWD Turbocharged Petrol engine.

Exterior:

- Available in Yulong White, Eiger Grey or Santorini Black
- Full Black Pack, including a Gloss Black finish to the side window surrounds, side vents with Chequered Flag badge, grille surround and door claddings
- S front bumper with body-coloured cheeks
- Fixed panoramic roof
- Gloss Black roof rails
- Heated windscreen
- 20" Style 5031, 5 split-spoke, Gloss Black.

Interior:

- Interior colours: Ebony/Pimento or Ebony/Light Oyster stitch
- 10-way electric front seats
- Heated steering wheel
- Metal treadplates with Chequered Flag branding
- Meshed Aluminium trim finisher
- Touch Pro
- Navigation Pro
- Interactive Driver Display
- Connect Pro
- Meridian™ Sound System
- CD/DVD player.



VEHICLE SHOWN: F-PACE CHEQUERED FLAG IN EIGER GREY WITH OPTIONAL FEATURES FITTED.



**300
SPORT**



NEW F-PACE 300 SPORT

F-PACE 300 SPORT demands attention. A distinctive Yellow theme begins at the branding on the brake calipers, and continues in the grille and tailgate 300 SPORT badges. Alone, it is nothing short of eye-catching. But combined with the Dark Satin Grey exterior trim, it creates a striking contrast that you just can't pull your eyes away from. Inside, the contemporary, driver-focused design has undergone the 300 SPORT treatment. Embossing to the headrests, badging on the soft grain leather steering wheel, and Yellow contrast stitching throughout, define the nature of this edition – exciting, and full of personality.

Features:

Available with 3.0 litre V6 300PS AWD Twin Turbocharged Diesel or Ingenium 2.0 litre 4-cylinder 300PS AWD Turbocharged Petrol engine.

Exterior:

- Available in Yulong White, Indus Silver or Santorini Black • Dark Satin Grey accents on the Gloss Black grille's surround, the front bumper, the rear bumper valance, the side window surrounds, the door mirror caps and the side door finishers • Fixed panoramic roof • Gloss Black roof rails • 22" Style 1020, 15 spoke, Gloss Grey with contrast inserts • Heated windscreen • 300 SPORT branded Black brake calipers • 300 SPORT grille and tailgate badge.

Interior:

- Ebony leather interior with Yellow contrast stitching throughout • 300 SPORT front headrest embossing • 10-way electric front seats with driver memory • 4-way electric lumbar adjust • 300 SPORT branded soft grain leather heated steering wheel with Yellow contrast stitch • Aluminium gearshift paddles • 300 SPORT carpet mats with Yellow contrast stitching • 300 SPORT treadplates • Touch Pro • Navigation Pro • Interactive Driver Display • Connect Pro • Meridian™ Sound System • CD/DVD player.



VEHICLE SHOWN: F-PACE 300 SPORT IN SANTORINI BLACK WITH OPTIONAL FEATURES FITTED.

PERSONALISATION F-PACE - YOUR CHOICE

 Configure your vehicle at jaguar.co.uk



CHOOSE YOUR ENGINE

Page 80

Select one of F-PACE's powerful, efficient petrol or diesel engines to suit your driving style.

CHOOSE YOUR MODEL & OPTIONS

Page 82

Compare the wealth of standard features and options on F-PACE models.

CHOOSE YOUR COLOUR

Page 94

Express your individuality with one of F-PACE's stunning exterior colours.

CHOOSE YOUR WHEELS

Page 96

Add the personal finishing touch to your new F-PACE, and complement its stunning style, with a set of beautifully designed alloy wheels.

CHOOSE YOUR INTERIOR

Page 98

There's a wide selection of premium materials, leathers, veneers and finishes for every personal taste.

CHOOSE YOUR JAGUAR GEAR - ACCESSORIES

Page 110

Really make it yours by adding style, practicality and versatility with official F-PACE Gear Accessories from your local Jaguar Retailer.

1 CHOOSE YOUR ENGINE

 Configure your vehicle at jaguar.co.uk

> DIESEL ENGINES

2.0 LITRE 4-CYLINDER RWD TURBOCHARGED

MAXIMUM POWER 163PS
MAXIMUM TORQUE 380Nm
ACCELERATION 0-60 mph 9.6 seconds
TOP SPEED 121 mph
PRESTIGE, PORTFOLIO, R-SPORT

2.0 LITRE 4-CYLINDER RWD TURBOCHARGED

MAXIMUM POWER 180PS
MAXIMUM TORQUE 430Nm
ACCELERATION 0-60 mph 8.1 seconds
TOP SPEED 129 mph
PRESTIGE, PORTFOLIO, R-SPORT

2.0 LITRE 4-CYLINDER AWD TURBOCHARGED

MAXIMUM POWER 180PS
MAXIMUM TORQUE 430Nm
ACCELERATION 0-60 mph 8.4 seconds
TOP SPEED 129 mph
PRESTIGE, PORTFOLIO, R-SPORT, CHEQUERED FLAG

2.0 LITRE 4-CYLINDER AWD TWIN TURBOCHARGED

MAXIMUM POWER 240PS
MAXIMUM TORQUE 500Nm
ACCELERATION 0-60 mph 6.8 seconds
TOP SPEED 135 mph
PRESTIGE, PORTFOLIO, R-SPORT, CHEQUERED FLAG

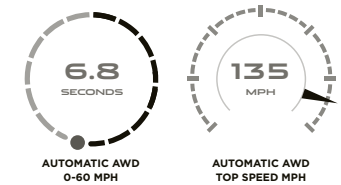
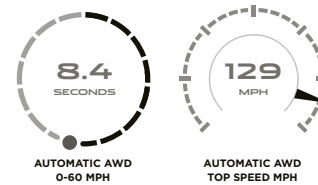
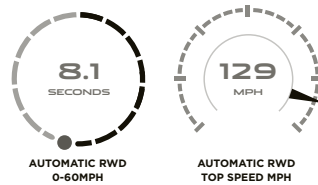
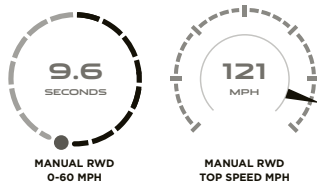

> PETROL ENGINES

3.0 LITRE V6 AWD

TWIN TURBOCHARGED

MAXIMUM POWER 300PS

MAXIMUM TORQUE 700Nm

ACCELERATION 0-60 mph 6.2 seconds

TOP SPEED 150 mph

PORTFOLIO, 300 SPORT, S

2.0 LITRE 4-CYLINDER AWD

TURBOCHARGED

MAXIMUM POWER 250PS

MAXIMUM TORQUE 365Nm

ACCELERATION 0-60 mph 6.6 seconds

TOP SPEED 135 mph

PRESTIGE, PORTFOLIO, R-SPORT, CHEQUERED FLAG

2.0 LITRE 4-CYLINDER AWD

TURBOCHARGED

MAXIMUM POWER 300PS

MAXIMUM TORQUE 400Nm

ACCELERATION 0-60 mph in 5.8 seconds

TOP SPEED 145 mph

PRESTIGE, PORTFOLIO, R-SPORT, 300 SPORT



AUTOMATIC AWD
0-60 MPH

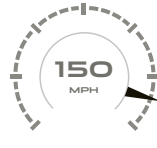

AUTOMATIC AWD
TOP SPEED MPH



AUTOMATIC AWD
0-60 MPH

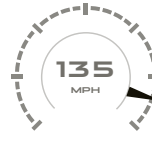

AUTOMATIC AWD
TOP SPEED MPH



AUTOMATIC AWD
0-60 MPH

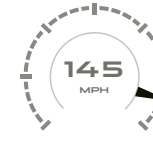

AUTOMATIC AWD
TOP SPEED MPH

2 CHOOSE YOUR MODEL

 Configure your vehicle at jaguar.co.uk

> LUXURY



PRESTIGE

KEY FEATURES

- 18" alloy wheels (Style 1018)
- Halogen headlights with halogen signature Daytime Running Lights
- Silver roof rails
- Powered tailgate
- Grained leather seats
- Suedecloth headlining
- Soft grain leather sport steering wheel
- Auto-dimming interior rear view mirror
- 40:20:40 split fold rear seat
- Illuminated metal treadplates with Jaguar script
- Navigation Pro
- Connect Pro
- Front and Rear Parking Aid
- Rear Camera



PORTFOLIO

KEY FEATURES (IN ADDITION/REPLACEMENT TO PRESTIGE)

- 19" alloy wheels (Style 7012)
- Xenon headlights with LED signature Daytime Running Lights
- Headlight power wash
- Fixed panoramic roof
- Heated windscreen
- Auto-dimming, power fold, heated door mirrors
- Perforated Windsor leather luxury seats
- 10-way electric front seats
- Etched Aluminium trim finisher
- Meridian™ Sound System
- Keyless Entry

Standard features may vary depending on engine variant and transmission. Please refer to the Specification and Price Guide or jaguar.co.uk

> SPORT



R-SPORT

KEY FEATURES (IN ADDITION/REPLACEMENT TO PRESTIGE)

- 19" alloy wheels (Style 5038)
- Xenon headlights with LED signature Daytime Running Lights
- Headlight power wash
- Front fog lights
- Gloss Black roof rails
- R-Sport body kit including R-Sport front and rear bumpers, body-coloured door claddings with Satin Black finishers
- Satin Chrome radiator grille surround and side power vents
- Gloss Black side window surrounds
- Perforated grained leather sport seats with contrast stitching
- Satin Chrome gearshift paddles (with automatic transmission)
- Etched Aluminium trim finisher
- Bright metal pedals



S

KEY FEATURES (IN ADDITION/REPLACEMENT TO R-SPORT)

- 20" alloy wheels (Style 5035)
- Adaptive Dynamics and Configurable Dynamics
- Red brake calipers
- 350mm front brakes
- Heated windscreen
- Auto-dimming, power fold, heated door mirrors
- S body kit including S front and rear bumpers, and body-coloured S door claddings with Satin Chrome finishers
- 10-way electric front seats
- Meshed Aluminium trim finisher
- Meridian Sound System (380w)
- Keyless Entry

2 CHOOSE YOUR OPTIONS

 Configure your vehicle at jaguar.co.uk

KEY STANDARD FEATURES

	PRESTIGE	PORTFOLIO	R-SPORT	S	DESCRIPTION
Stop/Start	●	●	●	●	Refer to page 60
Hill Launch Assist	●	●	●	●	Prevents your F-PACE from rolling backwards when pulling away on an incline, helping you to make the perfect hill start every time
JaguarDrive Control with Eco, Dynamic, Normal, Rain, Ice, Snow Mode	●	●	●	●	Refer to page 26
Electric Power Assisted Steering (EPAS)	●	●	●	●	Refer to page 37
Electric Parking Brake (EPB) with drive-away release	●	●	●	●	Automatically releases the parking brake without the need for driver input as you press the accelerator to drive away
Emergency Brake Assist	●	●	●	●	Increases braking pressure in an emergency situation
Emergency Braking	●	●	●	●	Refer to page 56
Hazard lights under heavy braking	●	●	●	●	
Airbags	●	●	●	●	Driver and front passenger with seat occupant detector for passenger, front side and full length side window curtain
Torque Vectoring by Braking (TVBB)	●	●	●	●	Refer to page 42
Dynamic Stability Control (DSC) and Electronic Traction Control (ETC)	●	●	●	●	Refer to page 45
Cruise Control and Speed Limiter	●	●	●	●	
Lane Keep Assist	●	●	●	●	Refer to page 56
Driver Condition Monitor	●	●	●	●	
Trailer Stability Assist (TSA)	●	●	●	●	Intervenes when the system detects sway or potentially dangerous movement to bring the trailer back under control. Refer to page 45
Electric front and rear windows with one-touch open/close and anti-trap	●	●	●	●	
Rain sensing windscreen wipers	●	●	●	●	
Two-zone Climate Control	●	●	●	●	
Bluetooth® connectivity and streaming	●	●	●	●	Refer to pages 49-53
DAB Radio	●	●	●	●	
Push Button Start	●	●	●	●	
10" Touch Pro	●	●	●	●	Refer to page 49
Protect	●	●	●	●	
Auto-dimming interior rear view mirror	●	●	●	●	
Smartphone Pack	●	●	●	●	Includes Android Auto™ and Apple CarPlay®. Refer to page 51

● Standard ○ Option — Not available ■ Part of Pack

Please consult your local Jaguar Retailer for details.

For a complete list of optional features and packs refer to the F-PACE Specification and Price Guide or configure your vehicle at jaguar.co.uk

KEY OPTIONAL FEATURES

		PRESTIGE	PORTFOLIO	R-SPORT	S	
TRANSMISSION AND DYNAMIC FEATURES		CODE				DESCRIPTION
6-speed Manual Transmission (only available on 2.0 litre 4-cylinder 163PS Turbocharged Diesel engine)	078CH	●	●	●	—	Refer to page 27
8-speed Automatic Transmission with Jaguar Sequential Shift (includes gearshift paddles and All Surface Progress Control)	078CA	○	○	○	●	Refer to page 26
Configurable Dynamics (requires automatic transmission)	184AB	○	○	○	●	
Adaptive Dynamics (requires automatic transmission and Configurable Dynamics)	027CW	○	○	○	●	Only available as part of the Adaptive Dynamics Pack on AWD vehicles
Adaptive Cruise Control (requires automatic transmission)	065AM	■	■	■	■	Refer to page 57. Only available as part of the Drive Pack
Adaptive Cruise Control with Steering Assist (requires automatic transmission)	065AJ	■	■	■	■	Refer to page 58. Only available as part of the Driver Assist Pack
Adaptive Surface Response (requires automatic transmission and AWD)	088IG	■	■	■	○	Refer to page 38. Part of the Adaptive Dynamics Pack
350mm front brakes (standard on 300PS engines)	020DA	○	○	○	●	

EXTERIOR FEATURES AND FINISHERS

EXTERIOR FEATURES AND TRIM						
Fixed panoramic roof	041CX	○	●	○	○	
Sliding panoramic roof	041CZ	○	○	○	○	
Powered tailgate	070AV	●	●	●	●	
Powered gesture tailgate (requires Keyless Entry)	070BA	○	○	○	○	
Chrome side window surround	081DA	●	●	○	○	
Gloss Black side window surrounds	081DB	—	—	●	●	
Silver roof rails	060BA	●	●	○	○	
Gloss Black roof rails	060BB	○	○	●	●	
R-Sport body kit		—	—	●	—	Includes R-Sport front bumper, body-coloured R-Sport door claddings with Satin Black finishers, Satin Chrome side power vents with R-Sport badge, R-Sport rear bumper
S body kit		—	—	—	●	Includes S front bumper, body-coloured S door claddings with Satin Chrome finishers, S rear bumper with Gloss Black finish and Satin Chrome diffuser
Delete powertrain badging (standard on 2.0 litre 4-cylinder 163PS Diesel engine)	057EV	○	○	○	—	
Red brake calipers	020BE	—	—	—	●	

2 CHOOSE YOUR OPTIONS

 Configure your vehicle at jaguar.co.uk

EXTERIOR FEATURES AND FINISHERS CONTINUED

		PRESTIGE	PORTFOLIO	R-SPORT	S	
GLASS AND EXTERIOR MIRRORS						DESCRIPTION
Solar attenuating windscreen (front screen only)	047EB	○	○	○	○	Filters sunlight to reduce glare and prevent harmful UV rays from entering the cabin
Heated front windscreen with heated washer jets	040AK	○	●	○	●	
Privacy glass	047DB	○	○	○	○	
Heated, electric door mirrors	030NA	●	—	●	—	
Auto-dimming, power fold, heated door mirrors with approach lights	030NK	○	●	○	●	Auto-dimming function not available on passenger side
Auto-dimming, power fold, heated door mirrors with memory and approach lights	030NL	■	■	■	■	Auto-dimming function not available on passenger side. Available as part of the Memory Pack

HEADLIGHTS AND LIGHTING

Halogen headlights with Daytime Running Lights	064DE	●	—	—	—	
Xenon headlights with LED signature Daytime Running Lights (requires headlight power wash)	064CW	○	●	●	●	
Adaptive LED headlights with LED signature Daytime Running Lights (requires headlight power wash and Auto High Beam Assist)	064GJ	○	○	○	○	
Headlight power wash (requires Xenon or Adaptive headlights)	064BV	○	●	●	●	
Front fog lights	064AP	○	○	●	●	

TOWING

Detachable tow bar	028EM	○	○	○	○	
Electrically deployable tow bar	028EJ	○	○	○	○	

EXTERIOR COLOURS

						(Please see pages 94-95 for full colour palette)
Solid paint		●	●	●	●	Refer to page 94
Metallic paint		○	○	○	○	Refer to pages 94-95
Premium metallic paint		○	○	○	○	Refer to page 95

WHEELS

						(Please see pages 96-97 to see the full range)
Tyre Repair System (with parcel shelf storage on Portfolio and S derivatives)	029SQ/029SJ	●	●	●	●	
Space saver spare wheel (19" diameter. No parcel shelf storage)	029NZ	○	○	○	○	When selected this feature decreases boot volume to 508 litres
Full size spare wheel (not available with loadspace storage rails)	028MA/028MB 028MC/028ME	○	○	○	○	When selected this feature decreases boot volume to 463 litres due to raised boot floor
Tyre Pressure Monitoring System (TPMS)	062AD	●	●	●	●	

● Standard ○ Option — Not available ■ Part of Pack

Please consult your local Jaguar Retailer for details.

For a complete list of optional features and packs refer to the F-PACE Specification and Price Guide or configure your vehicle at jaguar.co.uk

SEATING AND VENEERS

		PRESTIGE	PORTFOLIO	R-SPORT	S	
SEATING	CODE					DESCRIPTION
Heated front seats	033BV	●	●	●	●	
Heated front and rear seats	033EQ	○	○	○	○	
Heated and cooled front seats with heated rear seats (requires perforated leather electric front seats and 4-way electric lumbar adjust)	033GQ	○	○	○	○	
8-way manual front seats	033UW	●	—	●	—	
10-way electric front seats	033VD	○	●	○	●	Includes electric adjustment of fore/aft, cushion height, cushion tilt, squab recline and manual headrest height
10-way electric front seats with driver memory	033VE	■	■	■	■	Includes electric adjustment of fore/aft, cushion height, cushion tilt, squab recline and manual headrest height. Memory adjusts driver seat, mirror position and steering column. Only available as part of the Memory Pack for 10-way seats
4-way electric lumbar adjust (for 8-way or 10-way seats)	033JT	○	○	○	○	
14-way electric front Performance seats with driver and front passenger memory	300PH	—	—	■	■	Includes electric adjustment of fore/aft, cushion height, cushion tilt, squab recline, bolster and 4-way lumbar adjust. Memory adjusts driver and front passenger seats, mirror position and steering column. Only available as part of the Memory Pack for 14-way Performance seats
18-way electric front sport seats (includes 4-way electric lumbar adjust)	033VF	—	—	○	○	Includes electric adjustment of fore/aft, cushion height, cushion tilt, cushion extension, squab recline, bolster and 4-way lumbar adjust. Manual headrest height adjustment
18-way electric front sport seats with driver memory (includes 4-way electric lumbar adjust)	033VG	—	—	■	■	Includes electric adjustment of fore/aft, cushion height, cushion tilt, cushion extension, squab recline, bolster and 4-way lumbar adjust. Manual headrest height adjustment. Memory adjusts driver seat, mirror position and steering column. Only available as part of the Memory Pack for 18-way sport seats
20-way electric front luxury seats with driver and front passenger memory (includes 4-way electric lumbar adjust)	033UZ	—	■	—	—	Includes electric adjustment of fore/aft, cushion height, cushion tilt, cushion extension, squab recline, bolster, 4-way lumbar adjust and headrest height adjustment. Manual winged headrests. Memory adjusts driver and front passenger seats (not side bolsters and lumbar), mirror position and steering column. Only available as part of the Memory Pack for 20-way luxury seats
Grained leather seats	033AS	●	—	—	—	
Perforated grained leather seats (requires heated and cooled front seats with heated rear seats)	033JE	○	—	—	—	
Perforated Windsor leather seats	033JK	—	●	—	—	
Perforated grained leather sport seats	033YF	—	—	●	●	S model includes S logo embossed on front headrest
Rear armrest with twin cupholders	033LM	●	●	●	●	
Electrically reclining rear seats	033IR	○	○	○	○	
Rear seat remote release levers	034BA	○	○	○	○	
VENEERS						Please see pages 108-109 for full range of veneers

2 CHOOSE YOUR OPTIONS

 Configure your vehicle at jaguar.co.uk

HEADLINING AND INTERIOR FEATURES

		PRESTIGE	PORTFOLIO	R-SPORT	S	
HEADLINING						
Light Oyster headlining	032FE	●	●	○	○	Refer to pages 98-99
Ebony headlining	032BU	○	○	●	●	Refer to pages 98-99
Suedecloth headlining	088HE	●	●	●	●	Refer to pages 98-99
Morzine headlining	088HH	○	○	○	○	Refer to pages 98-99
INTERIOR FEATURES						
Illuminated front metal treadplates with Jaguar script	048BD	●	●	●	●	
Metal treadplates with R-Sport branding	048BN	—	—	○	—	
Metal treadplates with S branding	048BP	—	—	—	○	
Metal loadspace scuff plate	048BW	●	●	●	●	
Illuminated metal loadspace scuff plate (requires illuminated front metal treadplates. Not available with branded treadplates.)	048BE	○	○	○	○	
Rear metal treadplates		●	●	●	●	
Premium carpet mats	079BO	●	●	●	●	
Bright metal pedals	051AJ	○	○	●	●	
Soft grain leather sport steering wheel	032LH	●	●	—	—	
R-Sport branded soft grain leather steering wheel	032FN	—	—	●	—	
S branded soft grain leather steering wheel	032DW	—	—	—	●	
Black gearshift paddles (requires automatic transmission)	078CB	●	●	—	—	
Satin Chrome gearshift paddles (requires automatic transmission)	078CC	—	—	●	●	

● Standard ○ Option — Not available ■ Part of Pack

Please consult your local Jaguar Retailer for details.

For a complete list of optional features and packs refer to the F-PACE Specification and Price Guide or configure your vehicle at jaguar.co.uk

HEADLINING AND INTERIOR FEATURES CONTINUED

		PRESTIGE	PORTFOLIO	R-SPORT	S	
INTERIOR FEATURES	CODE					DESCRIPTION
Heated steering wheel	032DV	○	○	○	○	
Electrically adjustable steering column	049AP	■	■	■	■	Only available as part of seat Memory Packs
Four-zone Climate Control (requires Air Quality Sensor and lockable, cooled glovebox. Not available with 8-way manual front seats)	022BC	○	○	○	○	
Cabin Air Ionisation	022GB	○	○	○	○	
Air Quality Sensor and lockable cooled glovebox	022FA, 030DH	○	○	○	○	
Ambient Interior Lighting	064FB	●	●	●	●	
Configurable Ambient Interior Lighting (with 10 colours)	064FC	○	○	○	○	
Smoker's Pack	094AA	○	○	○	○	
Twin front cupholders (includes a cover with automatic transmission)	026SA / 026SB	●	●	●	●	
Power sockets	054AK	●	●	●	●	12v power socket located in row 1, row 2 and boot. 2x USB ports located in rear centre console
Loadspace safety partition net	026EU	○	○	○	○	
Loadspace storage rails (not available with full size spare wheel)	135AH	○	○	○	○	Loadspace storage rails are required for certain accessories. To find out more please refer to your Retailer or go to accessories.jaguar.com

2 CHOOSE YOUR OPTIONS

 Configure your vehicle at jaguar.co.uk

HEADLINING AND INTERIOR FEATURES CONTINUED

		PRESTIGE	PORTFOLIO	R-SPORT	S	
SAFETY AND SECURITY	CODE					DESCRIPTION
Front and Rear Parking Aid	189AD	●	●	●	●	
Rear Camera	086FA	●	●	●	●	
360° Surround Camera (requires auto-dimming, power fold, heated door mirrors)	086GC	○	○	○	○	Also available as part of the Driver Assist Pack. Refer to page 58
360° Parking Aid	189AF	■	■	■	■	Only available as part of Park Pack or Driver Assist Pack. Refer to pages 57-58
Garage door opener (HomeLink*)	025CT	○	○	○	○	
Lane Keep Assist and Driver Condition Monitor	086BG/086DH	●	●	●	●	
Park Assist	086MB	■	■	■	■	Available as part of the Park Pack and Driver Assist Pack. Refer to pages 57-58
Blind Spot Assist (requires automatic transmission and auto-dimming, power fold, heated door mirrors)	086GM	○	○	○	○	Also available as part of the Drive Pack and Driver Assist Pack. Refer to page 57
Rear Traffic Monitor	086KB	■	■	■	■	Also available as part of the Park Pack and Driver Assist Pack. Refer to pages 57-58
High-speed Emergency Braking (requires automatic transmission)	087CB	■	■	■	■	Also available as part of the Drive Pack and Driver Assist Pack. Refer to pages 57-58
Keyless Entry	066AC	○	●	○	●	
Activity Key	066CA	○	○	○	○	Refer to page 47

● Standard ○ Option — Not available ■ Part of Pack

*Stay connected while on the move. Your new F-PACE will arrive with a SIM card equipped with an essential data plan of 500MB of data per month for the initial warranty period. You'll be better connected, receiving live traffic updates and more. Additional data can be purchased. Terms, conditions and restrictions apply. Contact your local Jaguar Retailer for more information. InControl features, options and their availability remain market dependent - check with your Jaguar Retailer for local market availability and full terms. Mobile network connectivity cannot be guaranteed in all locations. InControl Apps and Remote App will need to be downloaded from the Apple/Play Store. All in-car features should be used by drivers only when safe for them to do so. Drivers must ensure they are in full control of the vehicle at all times.

Please consult your local Jaguar Retailer for details.

For a complete list of optional features and packs refer to the F-PACE Specification and Price Guide or [Configure your vehicle at jaguar.co.uk](http://jaguar.co.uk)

INCONTROL INFOTAINMENT AND CONNECTIVITY

		PRESTIGE	PORTFOLIO	R-SPORT	S	
INFOTAINMENT AND CONNECTIVITY FEATURES*	CODE					DESCRIPTION
10" Touch Pro	087AP	●	●	●	●	
Instrument cluster with 5" Central TFT Display	038IC	●	●	●	●	
Interactive Driver Display	038ID	○	○	○	○	Refer to page 49
Sound System	025KN	●	—	●	—	Refer to pages 54-55
Meridian™ Sound System	025LM	○	●	○	●	Refer to pages 54-55
Meridian™ Surround Sound System	025LN	○	○	○	○	Refer to pages 54-55
Digital Audio Broadcast (DAB) radio	025JB	●	●	●	●	
Digital TV (requires CD/DVD player)	129AA	○	○	○	○	
CD/DVD player	025AM	○	○	○	○	
Navigation Pro	087AU	●	●	●	●	Includes Traffic Sign Recognition and Adaptive Speed Limiter
Touch Pro Navigation Pack with Meridian™ Sound System	017EG	○	—	○	—	Includes Meridian™ Sound System, CD/DVD player and Interactive Driver Display
Touch Pro Navigation Pack with Meridian™ Surround Sound System	017EI	○	○	○	○	Includes Meridian™ Surround Sound System, CD/DVD player and Interactive Driver Display
InControl Apps	025PA	●	●	●	●	
Connect Pro	025RC / 011DA	●	●	●	●	Consists of Pro Services, Wi-Fi Hotspot and Remote Premium
10" Touch Pro Dual View (requires CD/DVD player and Meridian™ Sound System/ Meridian™ Surround Sound System)	087AS	○	○	○	○	
Protect	011BE	●	●	●	●	Refer to page 51
Secure Tracker	011AE	○	○	○	○	Refer to page 53

All in-car features should be used by drivers only when safe for them to do so. Drivers must ensure they are in full control of the vehicle at all times. Options specified may affect vehicle efficiency and pricing due to local taxation policy. Please configure at jaguar.co.uk or check with your local Retailer.

2 CHOOSE YOUR OPTIONS

 Configure your vehicle at jaguar.co.uk

OPTION PACKS

OPTION PACKS	CODE	PRESTIGE	PORTFOLIO	R-SPORT	S	DESCRIPTION
R-Sport Black Exterior Pack (not available with Silver roof rails)	032MC	—	—	○	—	Consists of Gloss Black side power vents with R-Sport badge, Gloss Black front grille and grille surround and body-coloured door claddings with Gloss Black finishers
S Black Exterior Pack (not available with Silver roof rails)	032MD	—	—	—	○	Consists of Gloss Black side power vents, Gloss Black front grille and grille surround, body-coloured door claddings with Gloss Black finishers and Gloss Black rear valance
Cold Climate Pack (not available with Rear Seat Comfort Pack)	017CA	○	—	○	—	Consists of heated front windscreen with heated washer jets, heated steering wheel and heated front and rear seats
Adaptive Dynamics Pack (requires automatic transmission and AWD)	017KA	○	○	○	—	Consists of Configurable Dynamics, Adaptive Dynamics and Adaptive Surface Response
Head-up Display Pack	017FG	○	○	○	○	Consists of solar attenuating windscreen and Head-up Display
Memory Pack for 10-way seats	017EC	○	○	○	○	Consists of 10-way electric front seats with manual headrest height and driver memory, auto-dimming, power fold heated door mirrors with memory and approach lights and electrically adjustable steering column.
Memory Pack for 14-way Performance seats	017GV	—	—	○	○	Consists of 14-way electric Performance front seats with driver and front passenger memory, heated and cooled front seats with heated rear seats, auto-dimming power fold heated door mirrors with memory and approach lights and electrically adjustable steering column.
Memory Pack for 18-way sport seats	017FL	—	—	○	○	Consists of 18-way electric sport front seats including 4-way electric lumbar adjust and driver memory, auto-dimming, power fold heated door mirrors with memory and approach lights and electrically adjustable steering column.
Memory Pack for 20-way luxury seats	017GJ	—	○	—	—	Consists of 20-way electric luxury front seats with 4-way electric lumbar adjust and driver and front passenger memory, auto-dimming, power fold, heated door mirrors with memory and approach lights, electrically adjustable steering column.

● Standard ○ Option — Not available

Please consult your local Jaguar Retailer for details.

For a complete list of optional features and packs refer to the F-PACE Specification and Price Guide or [Configure your vehicle at jaguar.co.uk](http://jaguar.co.uk)

OPTION PACKS CONTINUED

OPTION PACKS	CODE	PRESTIGE	PORTFOLIO	R-SPORT	S	DESCRIPTION
Rear Seat Comfort Pack (not available with Cold Climate Pack or 8-way front seats)	017FS	<input type="radio"/>	<input type="radio"/>	<input type="radio"/>	<input type="radio"/>	Consists of heated front and rear seats, Air Quality Sensor and lockable cooled glovebox, electrically reclining rear seats and Four-zone Climate Control
Practicality Pack	017JA	<input type="radio"/>	<input type="radio"/>	<input type="radio"/>	<input type="radio"/>	Consists of rear seat remote release levers, powered gesture tailgate, loadspace safety partition net, Air Quality Sensor, lockable cooled glovebox and Keyless Entry
Park Pack	017UA	<input type="radio"/>	<input type="radio"/>	<input type="radio"/>	<input type="radio"/>	Consists of Park Assist, 360° Parking Aid and Rear Traffic Monitor
Drive Pack (requires automatic transmission and auto-dimming, power fold, heated door mirrors with approach lights)	017TA	<input type="radio"/>	<input type="radio"/>	<input type="radio"/>	<input type="radio"/>	Consists of Blind Spot Assist, High-speed Emergency Braking and Adaptive Cruise Control
Driver Assist Pack (requires automatic transmission and auto-dimming, power fold, heated door mirrors with approach lights)	017TE	<input type="radio"/>	<input type="radio"/>	<input type="radio"/>	<input type="radio"/>	Consists of Blind Spot Assist, High-speed Emergency Braking, Adaptive Cruise Control with Steering Assist, 360° Surround Camera, Park Assist, Rear Traffic Monitor and 360° Parking Aid

3 CHOOSE YOUR COLOUR



Configure your vehicle at jaguar.co.uk

SOLID

Fuji White

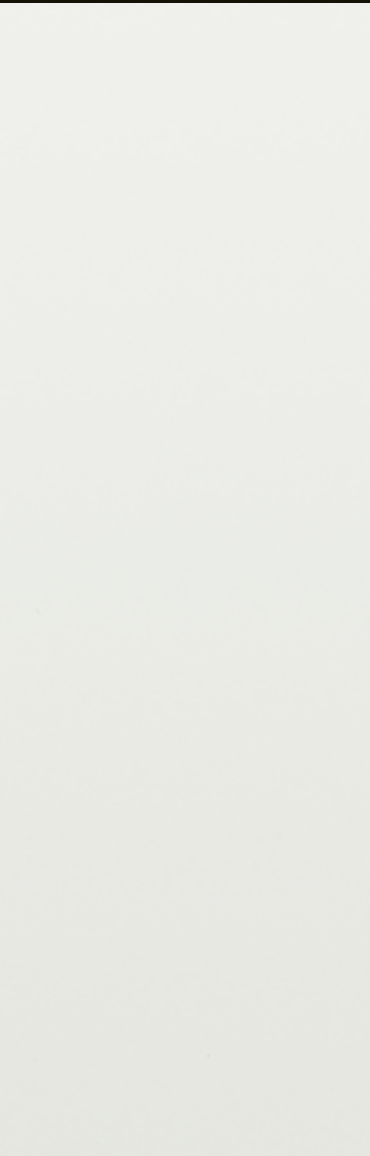

Narvik Black



METALLIC

Yulong White



Santorini Black



Eiger Grey



Portofino Blue



Caesium Blue



Firenze Red



Indus Silver



PREMIUM PALETTE

Silicon Silver



Carpathian Grey



4 CHOOSE YOUR WHEELS

 Configure your vehicle at jaguar.co.uk



18" STYLE 1022,
15 SPOKE

18" STYLE 1021,
10 SPOKE

18" STYLE 1018,
10 SPOKE

19" STYLE 5037,
5 SPOKE

ALLOY WHEEL FINISH	Gloss Sparkle Silver	Gloss Sparkle Silver	Gloss Sparkle Silver	Gloss Sparkle Silver
ALLOY WHEEL/SIZE	7.5J x 18"	7.5J x 18"	7.5J x 18"	8.5J x 19"
TYRE SIZE	235/65 R18 255/60 R18	235/65 R18 255/60 R18	255/60 R18	255/55 R19
CODE	029YH	029YF	029YG	029YK

Prestige	<input type="radio"/>	<input type="radio"/>	<input checked="" type="radio"/>	<input type="radio"/>
Portfolio	<input type="radio"/>	<input type="radio"/>	<input type="radio"/>	<input type="radio"/>
R-Sport	<input type="radio"/>	<input type="radio"/>	<input type="radio"/>	<input type="radio"/>
S	—	—	—	—



19" STYLE 5037,
5 SPOKE

19" STYLE 7012,
7 SPLIT-SPOKE

19" STYLE 5038,
5 SPLIT-SPOKE

20" STYLE 1019,
10 SPLIT-SPOKE

ALLOY WHEEL FINISH	Gloss Black	Gloss Sparkle Silver	Gloss Grey and Diamond Turned	Gloss Shadow Chrome
ALLOY WHEEL/SIZE	8.5J x 19"	8.5J x 19"	8.5J x 19"	8.5J x 20"
TYRE SIZE	255/55 R19	255/55 R19	255/55 R19	255/50 R20
CODE	031JM	029YJ	029YL	029XX

Prestige	—	<input type="radio"/>	<input type="radio"/>	<input type="radio"/>
Portfolio	—	<input checked="" type="radio"/>	<input type="radio"/>	<input type="radio"/>
R-Sport	<input type="radio"/>	<input type="radio"/>	<input checked="" type="radio"/>	<input type="radio"/>
S	—	—	—	<input type="radio"/>

● Standard ○ Option — Not Applicable

Fuel consumption/emissions figures will vary based on tyre size. Please refer to the accompanying Technical Specification for full details on driveline, engine performance and fuel economy.



20" STYLE 5031,
5 SPLIT-SPOKE

20" STYLE 5031,
5 SPLIT-SPOKE

20" STYLE 5036,
5 SPLIT-SPOKE

20" STYLE 5035,
5 SPOKE

ALLOY WHEEL FINISH	Gloss Black	Gloss Grey and Diamond Turned	Gloss Sparkle Silver	Gloss Grey and Diamond Turned
ALLOY WHEEL/SIZE	8.5J x 20"	8.5J x 20"	8.5J x 20"	8.5J x 20"
TYRE SIZE	255/50 R20	255/50 R20	255/50 R20	255/50 R20
CODE	029XZ	029XY	029XW	029YN

Prestige	—	○	○	○
Portfolio	—	○	○	○
R-Sport	○	○	○	○
S	○	○	○	●



20" STYLE 5035,
5 SPOKE

22" STYLE 1020,
15 SPOKE

22" STYLE 1020,
15 SPOKE

22" STYLE 1020,
15 SPOKE

ALLOY WHEEL FINISH	Gloss Black	Gloss Silver with contrast inserts	Gloss Black with Satin Black inserts	Gloss Grey with contrast inserts
ALLOY WHEEL/SIZE	8.5J x 20"	9.0J x 22"	9.0J x 22"	9.0J x 22"
TYRE SIZE	255/50 R20	265/40 R22	265/40 R22	265/40 R22
CODE	029YP	029YA	029YB	029YE

Prestige	—	○	—	○
Portfolio	—	○	—	○
R-Sport	○	○	○	○
S	○	○	○	○

Options specified may affect vehicle efficiency and pricing due to local taxation policy. Please configure at jaguar.co.uk or check with your local Retailer.

5 CHOOSE YOUR INTERIOR

 Configure your vehicle at jaguar.co.uk

PRESTIGE						
	SEAT WITH CONTRAST STITCH	FINISHER	HEADLINING SUEDECLOTH ¹	UPPER FACIA WITH TONAL STITCH	CARPET	INTERIOR TRIM AND OPTION CODES
Standard						
Grained leather seats	Ebony with Siena Tan	Gloss Black	Light Oyster or Ebony ²	Ebony with Ebony	Ebony	SEE
	Latte with Espresso	Gloss Black	Light Oyster	Espresso with Espresso	Espresso	TZE
	Light Oyster with Pistachio	Gloss Black	Light Oyster or Ebony ²	Ebony with Ebony	Ebony	SEF
PORTFOLIO						
	SEAT WITH TONAL STITCH	FINISHER	HEADLINING SUEDECLOTH ¹	UPPER FACIA WITH TONAL STITCH	CARPET	INTERIOR TRIM AND OPTION CODES
Standard						
Perforated Windsor leather seats	Ebony with Ebony	Etched Aluminium	Light Oyster or Ebony ²	Ebony with Ebony	Ebony	SEP
	Espresso with Espresso	Etched Aluminium	Light Oyster	Espresso with Espresso	Espresso	TZT
	Siena Tan with Siena Tan	Etched Aluminium	Light Oyster or Ebony ²	Ebony with Ebony	Ebony	SEQ
	Latte with Latte	Etched Aluminium	Light Oyster	Espresso with Espresso	Espresso	TZR
	Light Oyster with Light Oyster	Etched Aluminium	Light Oyster	Oyster with Oyster	Oyster	TZS

¹Morzine headlining available as an option.

²Ebony headlining available as an option.

³Light Oyster headlining available as an option.

R-SPORT						
	SEAT WITH CONTRAST STITCH	FINISHER	HEADLINING SUEDECLOTH¹	UPPER FACIA WITH CONTRAST STITCH	CARPET	INTERIOR TRIM AND OPTION CODES
Standard						
Perforated grained leather sport seats	Ebony/Ebony with Light Oyster	Etched Aluminium	Ebony or Light Oyster ³	Ebony with Light Oyster	Ebony	SEG
	Ebony/Pimento with Pimento	Etched Aluminium	Ebony or Light Oyster ³	Ebony with Pimento	Ebony	SEH
	Ebony/Light Oyster with Light Oyster	Etched Aluminium	Ebony or Light Oyster ³	Ebony with Light Oyster	Ebony	SEJ
	Oyster/Oyster with Lime	Etched Aluminium	Light Oyster	Oyster with Lime	Oyster	SEV
Optional						
Perforated grained leather Performance seats	Ebony/Ebony with Light Oyster	Etched Aluminium	Ebony or Light Oyster ³	Ebony with Light Oyster	Ebony	SEG+017GV (Performance seat upgrade)
	Light Oyster/Ebony with Light Oyster	Etched Aluminium	Ebony or Light Oyster ³	Ebony with Light Oyster	Ebony	SEN+017GV (Performance seat upgrade)
S						
	SEAT WITH CONTRAST STITCH	FINISHER	HEADLINING SUEDECLOTH¹	UPPER FACIA WITH NO STITCH	CARPET	INTERIOR TRIM AND OPTION CODES
Standard						
Perforated grained leather sport seats	Ebony/Ebony with Light Oyster	Meshed Aluminium	Ebony or Light Oyster ³	Ebony with Light Oyster	Ebony	SEK
	Pimento/Ebony with Ebony	Meshed Aluminium	Ebony or Light Oyster ³	Ebony with Pimento	Ebony	SEL
	Brogue/Brogue with Light Oyster	Meshed Aluminium	Ebony or Light Oyster ³	Ebony with Light Oyster	Ebony	SEM
	Light Oyster/Ebony with Ebony	Meshed Aluminium	Ebony or Light Oyster ³	Ebony with Light Oyster	Ebony	SEN
Optional						
Perforated grained leather Performance seats	Ebony/Ebony with Light Oyster	Meshed Aluminium	Ebony or Light Oyster ³	Ebony with Light Oyster	Ebony	SEK+017GV (Performance seat upgrade)
	Light Oyster/Ebony with Light Oyster	Meshed Aluminium	Ebony or Light Oyster ³	Ebony with Light Oyster	Ebony	SEN+017GV (Performance seat upgrade)

5 CHOOSE YOUR INTERIOR

⚙️ Configure your vehicle at jaguar.co.uk

Interior shown: Latte grained leather seats with Espresso contrast stitch, Gloss Black finisher with Light Oyster headlining and Espresso facia.



PRESTIGE

INTERIOR COLOUR COMBINATIONS

STANDARD

	①	②	③	④	⑤
SEE	SEAT WITH CONTRAST STITCH Ebony with Siena Tan	FINISHER Gloss Black	HEADLINING SUEDECLOTH ¹ Light Oyster or Ebony ²	UPPER FACIA WITH TONAL STITCH Ebony with Ebony	CARPET Ebony
TZE	Latte with Espresso	Gloss Black	Light Oyster	Espresso with Espresso	Espresso
SEF	Light Oyster with Pistachio	Gloss Black	Light Oyster or Ebony ²	Ebony with Ebony	Ebony

FINISHER OPTIONS

Satin Fine Line Wood, Satin Burr Ash, Satin Grey Ash, Satin Grey Figured Ebony, Gloss Figured Ebony, Etched Aluminium, Meshed Aluminium or Carbon Fibre

¹Morzine headlining available as an option.
²Ebony headlining available as an option.

5 CHOOSE YOUR INTERIOR

Configure your vehicle at jaguar.co.uk













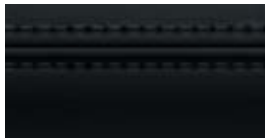











Interior shown: Siena Tan Windsor leather seats with Siena Tan tonal stitch, optional Gloss Figured Ebony finisher

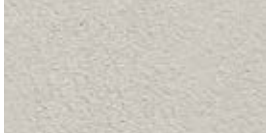

PORTFOLIO

INTERIOR COLOUR COMBINATIONS

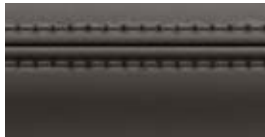
STANDARD

	1	2	3	4	5
	SEAT WITH TONAL STITCH	FINISHER	HEADLINING SUEDECLOTH ¹	UPPER FACIA WITH TONAL STITCH	CARPET
SEP	 Ebony with Ebony	 Etched Aluminium	 Light Oyster or Ebony ²	 Ebony with Ebony	 Ebony
TZI	 Espresso with Espresso	 Etched Aluminium	 Light Oyster	 Espresso with Espresso	 Espresso
SEQ	 Siena Tan with Siena Tan	 Etched Aluminium	 Light Oyster or Ebony ²	 Ebony with Ebony	 Ebony
TZR	 Latte with Latte	 Etched Aluminium	 Light Oyster	 Espresso with Espresso	 Espresso
TZS	 Light Oyster with Light Oyster	 Etched Aluminium	 Light Oyster	 Oyster with Oyster	 Oyster

FINISHER OPTIONS

Satin Fine Line Wood, Satin Burr Ash, Satin Grey Ash, Satin Grey Figured Ebony, Gloss Black, Gloss Figured Ebony, Meshed Aluminium or Carbon Fibre

¹Morzine headlining available as an option.

²Ebony headlining available as an option.

5 CHOOSE YOUR INTERIOR

Configure your vehicle at jaguar.co.uk

Interior shown: Optional Ebony and Pimento grained leather sport seats with Pimento contrast stitch, optional Etched Aluminium finisher with Ebony headlining and Ebony facia.



R-SPORT

INTERIOR COLOUR COMBINATIONS

STANDARD

	1	2	3	4	5
SEG	SEAT WITH CONTRAST STITCH Ebony/Ebony with Light Oyster ²	FINISHER Etched Aluminium	HEADLINING SUEDECLOTH ¹ Ebony or Light Oyster ³	UPPER FACIA WITH CONTRAST STITCH Ebony with Light Oyster	CARPET Ebony
SEH	Ebony/Pimento with Pimento	Etched Aluminium	Ebony or Light Oyster ³	Ebony with Pimento	Ebony
SEJ	Ebony/Light Oyster with Light Oyster	Etched Aluminium	Ebony or Light Oyster ³	Ebony with Light Oyster	Ebony
SEV	Oyster/Oyster with Lime	Etched Aluminium	Light Oyster	Oyster with Lime	Oyster

FINISHER OPTIONS

Satin Fine Line Wood, Satin Burr Ash, Satin Grey Ash, Satin Grey Figured Ebony, Gloss Figured Ebony, Gloss Black, Meshed Aluminium or Carbon Fibre

¹Morzine headlining available as an option.

²Also available with Performance seats.

³Light Oyster headlining available as an option.

5 CHOOSE YOUR INTERIOR

Configure your vehicle at jaguar.co.uk

Interior shown: Optional Brogue grained leather sport seats with Light Oyster contrast stitch, Meshed Aluminium finisher with Ebony headlining and Ebony facia.



S

INTERIOR COLOUR COMBINATIONS

STANDARD

	①	②	③	④	⑤
SEK	SEAT WITH CONTRAST STITCH Ebony/Ebony with Light Oyster ²	FINISHER Meshed Aluminium	HEADLINING SUEDECLOTH ¹ Ebony or Light Oyster ³	UPPER FACIA WITH CONTRAST STITCH Ebony with Light Oyster	CARPET Ebony
SEL	Pimento/Ebony with Ebony	Meshed Aluminium	Ebony or Light Oyster ³	Ebony with Pimento	Ebony
SEM	Brogue/Brogue with Light Oyster	Meshed Aluminium	Ebony or Light Oyster ³	Ebony with Light Oyster	Ebony
SEN	Light Oyster/Ebony with Ebony ⁴	Meshed Aluminium	Ebony or Light Oyster ³	Ebony with Light Oyster	Ebony

FINISHER OPTIONS

Satin Fine Line Wood, Satin Burr Ash, Satin Grey Ash, Satin Grey Figured Ebony, Gloss Figured Ebony, Etched Aluminium, Gloss Black or Carbon Fibre

¹Morzine headlining available as an option.

²Also available with Performance seats.

³Light Oyster headlining available as an option.

⁴Also available with Performance seats. Trim also available on R-Sport Performance seats.

5 CHOOSE YOUR INTERIOR

 Configure your vehicle at jaguar.co.uk

Gloss Black trim finisher

Meshed Aluminium trim finisher

Etched Aluminium trim finisher

Carbon Fibre trim finisher

Gloss Figured Ebony veneer

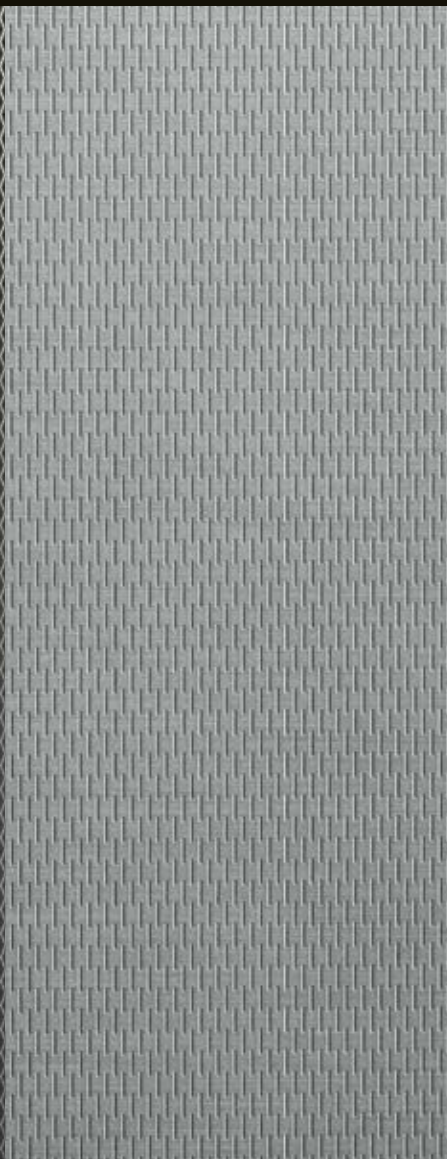

Satin Grey Figured Ebony veneer



Satin Fine Line Wood veneer



Satin Burr Ash veneer



Satin Grey Ash veneer



6 CHOOSE YOUR JAGUAR GEAR - ACCESSORIES

To find out more about the full range of Retailer fit Jaguar Gear Accessories, please refer to your Retailer or go to jaguar.co.uk/accessories



Ski/Snowboard Holder¹

A safe and secure Jaguar branded system for transporting winter sports equipment. Incorporates slider rails for easy loading. For four pairs of skis or two snowboards.

¹Requires roof rails and roof cross bars. ²Automatic transmission only.

VEHICLE SHOWN: F-PACE R-SPORT IN FIRENZE RED WITH OPTIONAL FEATURES AND RETAILER-FIT ACCESSORIES



Luggage Compartment Finisher

Luggage compartment finisher enhances the luggage compartment area and protects the lip when loading or unloading. Manufactured from stainless steel with a brushed, Bright finish, it provides a premium finish to the luggage compartment area.



Union Jack Sill Treadplates

Elegantly styled stainless steel sill treadplate finisher for driver or passenger doors featuring a distinctly British design.



Click and Play - iPad® 2-4

Click and Play is a removable tablet holder attachment which is available for various tablets, and can be easily positioned in multiple angles for in cabin comfort and rear entertainment.



Click and Hang

Click and Hang is a removable coat hanger, allowing shirts and jackets to be kept crease-free whilst transporting.



Central Armrest Chiller / Warmer

Food and drinks chiller and warmer that acts as a rear centre armrest. With a leather-covered top, it is held in place by the centre seat belt and powered from the rear auxiliary socket. Ideal for long journeys with the family.



Aluminium Gearshift Paddles²

Replacement steering wheel gearshift paddles offered in a premium aluminium material providing a high-quality finish to a key contact point in the vehicle. Manufactured from billet machined aluminium, the paddles are hand brushed for a premium finish and anodised to ensure they will not deteriorate with wear.

6 CHOOSE YOUR JAGUAR GEAR - ACCESSORIES

 Configure your vehicle at jaguar.co.uk



Carbon Fibre Side Power Vent

High grade Carbon Fibre side power vents provide a performance-inspired styling upgrade.



Gloss Black Side Power Vent

Gloss Black side power vents provide a dynamic exterior styling enhancement.



Wind Deflector

Simple to fit and remove, these wind deflectors will add to front seat passenger comfort by allowing air to circulate the cabin whilst reducing draughts and preventing rain from entering the vehicle. Kit includes two front and two rear deflectors.



Carbon Fibre Mirror Cover

High grade Carbon Fibre mirror covers provide a performance-inspired styling upgrade.



Gloss Black Mirror Cover

Gloss Black mirror covers accentuate the dynamic design of the exterior mirrors.



Chrome Mirror Cover

Chrome mirror covers accentuate the stylish design of the exterior mirrors.



Electrically Deployable Side Steps
Please contact your nearest Jaguar Retailer for fitment options

These smart, practical steps make it easier to get in and out of the vehicle and improve access to the roof. Neatly stowed under the sills, the side steps automatically deploy as soon as the door is opened. They stow automatically when the door is closed.



Fixed Side Steps

The side steps aid entry and exit to the vehicle and improve access to the roof. Design features Jaguar branding and includes Bright Stainless Steel edge trim and a rubber tread mat, to complement the vehicle's exterior styling cues.



Bright Side Tubes

Highly polished stainless steel side tubes complement the vehicle's exterior style.



Front Splash Guards

Jaguar branded, front splash guards complement the lines of your vehicle and provide protection from dirt and stone chippings.



Rear Splash Guards

Jaguar branded, rear splash guards complement the lines of your vehicle and provide protection from dirt and stone chippings.



Tow Bar Mounted Cycle Carrier

Premium tow ball mounted cycle carriers provide a convenient bike carrying solution with quick release loading attachments and secure locking mechanism. Clever design allows carrier to be tilted away from vehicle when fitted allowing access into the rear tailgate.

6 CHOOSE YOUR JAGUAR GEAR - ACCESSORIES

 Configure your vehicle at jaguar.co.uk



Luggage Compartment Rubber Mat¹

This premium mat is tailored specifically to protect the luggage compartment. Light and durable, it is easily removable for cleaning.



Premium Luggage Compartment Carpet Mat¹

Luxurious soft luggage mat in Ebony with the Jaguar logo. Deep premium 2,050g/m² pile with Nubuck edging and Dove contrast stitch.



Luggage Compartment Partition Net

Convenient partition net fitting to luggage compartment D-loops and fixings in roof lining.



Luggage Compartment Partition - Divider²

Offered as an addition to the full or half height luggage compartment partition to separate the loadspace into two sections across the width of the vehicle.



Pet Care and Access Pack

Taking the effort out of transporting pets, this option ensures everything required is to hand to transport pets in comfort. Combines the quilted loadspace liner, pet access ramp, portable rinse system, and full height luggage partition.



Bumper Protector

Convenient pull-out protector provides protection for the rear bumper from scratches and scuffs, helping to prevent clothing from collecting dirt from the bumper during loading/unloading. Manufactured from a robust fabric material, the bumper protector has been designed to concertina into the space under the luggage compartment floor for stowage.

¹Not available with full size spare wheel. ²Not compatible with rear loadspace cover, rubber loadspace liner and not available for vehicles with full size spare wheel. ³Requires roof rails. ⁴Requires roof cross bars.



Roof Cross Bars³

Jaguar branded cross bars required for fitting all roof carrying equipment. Engineered specifically for your vehicle.



Ski/Snowboard Holder^{3,4}

A safe and secure Jaguar branded system for transporting winter sports equipment. Incorporates slider rails for easy loading. For four pairs of skis or two snowboards.



Water Sports Carrier^{3,4}

A versatile system for transporting a variety of water sports equipment including surfboard, kayak or sailboard. Tilts to facilitate loading/unloading.



Wheel Mounted Cycle Carrier^{3,4}

An easy to fit, roof mounted, lockable cycle carrier which carries one bike per holder. A maximum of three holders can be fitted. Maximum cycle weight 20kg per carrier. Requires roof cross bars T4A13875. Suitable for an adult sized bike. Small/child sized bike not applicable for fitment. Consideration should always be given to vehicle's maximum roof load capacity to ensure this is not exceeded.



Roof Sport Box - Large^{3,4}

Power-click quick mounting system with integrated torque indicator for easy and secure fixing with a single-handed grip. The 430 litre large roof sport box opens from both sides with handles on the lid and inside the box, for convenient fitting, loading and unloading. Gloss Black finish and lockable for security.



UV Sunshade - Front Windscreen

Tailor-made for the F-PACE windscreen and features Jaguar branding. Reflects the sun's rays and helps to keep the interior of the vehicle cool.

THE WORLD OF JAGUAR

Your Jaguar drives with an instinct for performance, refined through decades of innovative design and engineering. Power and agility are combined with elegance and grace to deliver a vehicle like no other. As a celebration of Jaguar, we've created a range of experiences, publications and the Jaguar Lifestyle Collection. To top it all, we've even returned to the track with Jaguar Racing. Welcome to a world where every aspect of performance is an art.

EXPERIENCE DRIVES



There's no better way of understanding the spirit of Jaguar than by getting behind the wheel. Jaguar Experience Drives are an opportunity to unleash the breathtaking performance of our incredible Jaguar range. Join us at one of our Experience Centres, or take part in the Art of Performance Tour. New sensations await.

[jaguar.co.uk/experience](https://www.jaguar.co.uk/experience)

JAGUAR LAND ROVER ICE ACADEMY



Take your driving to the next level with Jaguar Land Rover Ice Academy. Located on one of the many frozen lakes in Arjeplog, Sweden, your driving skills will be tested through tackling some of the harshest, most challenging tracks on the planet. It's a rare chance to dance on ice and glide around awe-inspiring corners, all under the expert guidance of our instructors. Encounter the true exhilarating potential of the latest Jaguar and Land Rover vehicles in extreme conditions.

[jaguar.co.uk/experience](https://www.jaguar.co.uk/experience)

Follow us on:



MANUFACTURING TOURS



Witness at first-hand a Jaguar being brought to life. Behind our award-winning craftsmanship lies an unrivalled harmony of skilled technicians and cybernetic production robots. Our expert tour guides will accompany you as you make your way through the hi-tech manufacturing process, from sheet metal to the finished creation.

jaguar.co.uk/experience-jaguar

SPECIAL VEHICLE OPERATIONS



With outstanding performance, cutting-edge technology and incomparable luxury, Jaguar is a showcase for the finest in design and engineering. Special Vehicle Operations takes this even further. Adorned with the SV badge, halo models and limited-run collector's editions are the very pinnacle of the Jaguar range, offering a combination of the ultimate in power and dynamics.

jaguar.co.uk/about-jaguar/special-vehicle-operations

ABB FIA FORMULA E

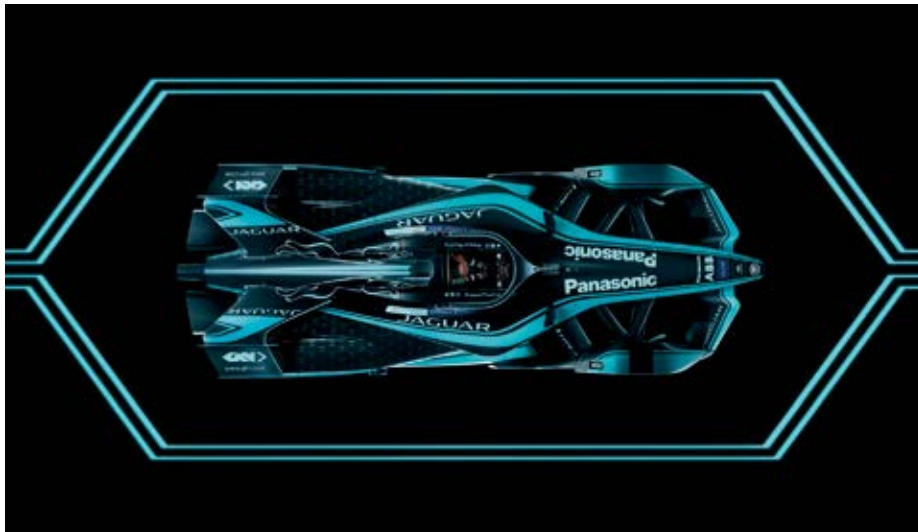

Jaguar's reputation for performance, technology and design was forged at the world's most challenging circuits and championships. From Le Mans to Formula 1, and now Formula E, the grid is our test bed. Formula E provides the perfect proving ground for electric vehicle technology in a high-performance environment. The racing series accelerates the development of Jaguar's electric powertrains. With every race, Formula E helps Jaguar engineers to create better electric vehicles.

jaguar.co.uk/jaguar-racing

JAGUAR I-PACE eTROPHY



We're making history. Again. Our latest development as leader in the global automotive race to electrification is I-PACE eTrophy - the world's first all-electric production-based international race series. Engineered and built by Special Vehicle Operations to compete on the zero emissions world stage; racers of the future will push electrification to thrilling heights.

jaguar.co.uk/electrification/i-pace-e-trophy

Follow us on:



THE JAGUAR LIFESTYLE COLLECTION



Our latest range of apparel and lifestyle accessories is inspired by Jaguar's rich heritage, racing expertise, and iconic designs. This exclusive, impressively executed collection follows the performance-orientated style that is Jaguar.

jaguar.co.uk/branded-goods

THE JAGUAR MAGAZINE



This is our own vibrant, cosmopolitan and contemporary magazine. Go behind the scenes at Jaguar and explore our dedication to performance, design and innovation - as well as catching an insight into the world of luxury, style and travel. You can enjoy The Jaguar magazine twice a year, completely free of charge for the first three years of ownership. Ask your local Jaguar Retailer to ensure that you receive your copy.

jaguar.co.uk/magazine



AT YOUR SERVICE

As well as providing a range of exclusive services and lifestyle products, the World of Jaguar makes owning and driving carefree and easy.

GENUINE PARTS

Jaguar Genuine Parts are designed, tested and manufactured to our uncompromising standards for quality, fit and durability. Each part is engineered specifically for your F-PACE to contribute to optimum performance and to help maximise its lifespan.

FLEET & BUSINESS

Jaguars are dynamic and distinctive cars that help companies express the unique character and personality of their business. We are committed to providing customer-focused aftersales services, ensuring that every Jaguar performs to the highest standard and in the most cost-efficient way for businesses. Visit jaguar.co.uk/fleet-and-business for more information.

JAGUAR ASSISTANCE

Jaguar Assistance provides assistance in motoring emergencies, from immobilisation due to breakdown or accident to minor problems such as punctures. You can rely on our roadside assistance, whatever the situation, wherever you happen to be.

JAGUAR FINANCIAL SERVICES

New or used, for personal or business use, we have a finance option that puts you in complete control. Please speak to your local Jaguar Retailer to find out more.

INSURANCE

F-PACE's key components are easily accessible for time-efficient service and repair costs. With a focus on lower repair costs, F-PACE delivers competitive insurance group ratings. To find out more about the compelling business case for F-PACE, please contact your local Jaguar Retailer.

IMPORTANT NOTICE

Jaguar Land Rover Limited is constantly seeking ways to improve the specification, design and production of its vehicles, parts and accessories and alterations take place continually. Whilst every effort is made to produce up to date literature, this brochure should not be regarded as an infallible guide to current specifications or availability, nor does it constitute an offer for the sale of any particular vehicle, part or accessory. Distributors and retailers are not agents of Jaguar Land Rover Limited by any express or implied undertaking or representation.

COLOURS

Images are provided for illustrative purposes only. Colours reproduced on-screen may vary compared to actual finish. The company reserves the right to alter or withdraw any colour finish without notice. Some of these colours may not be obtainable in your country. Please check availability of colours and current specifications with your Jaguar Retailer. Distributors and retailers are not agents of Jaguar Land Rover Limited and have absolutely no authority to bind Jaguar Land Rover Limited to any express or implied undertaking or representation.

ENVIRONMENTAL INNOVATION AT JAGUAR

Jaguar is committed to reducing dependency on fossil fuels, using fewer natural resources and creating less waste as part of our approach to responsible and sustainable business development.

Search 'Jaguar Environmental Innovation' for more details.

Castrol EDGE Professional exclusively recommended by Jaguar.

Meridian is the registered trademark of Meridian Audio Ltd.

HomeLink® is a registered trademark of Gentex Corporation.

Android Auto is a trademark of Google Inc.

The Bluetooth® word mark and logos are owned by the Bluetooth SIG, Inc. and any use of such marks by Jaguar Land Rover Limited is under license. iPhone is a trademark of Apple Inc., registered in the US and other countries. The navigation system must always be used in conditions that will not affect the driver's ability to drive safely or affect the safety of other road users.

VEHICLE SHOWN: F-PACE PORTFOLIO IN YULONG WHITE WITH OPTIONAL FEATURES AND RETAILER-FIT ACCESSORIES

VEHICLE SHOWN FRONT COVER: F-PACE S IN CAESIUM BLUE WITH OPTIONAL FEATURES FITTED

VEHICLE SHOWN BACK COVER: F-PACE R-SPORT IN FIRENZE RED WITH OPTIONAL FEATURES AND RETAILER-FIT ACCESSORIES

Jaguar Land Rover Limited
Registered Office: Abbey Road, Whitley,
Coventry, CV3 4LF, United Kingdom

Registered in England Number: 1672070

jaguar.co.uk

© Copyright Jaguar Land Rover Limited 2019

1X7612010000BGBEN01P
20MY / March 2019



JAGUAR F-PACE

TECHNICAL SPECIFICATION
MARCH 2019



JAGUAR F-PACE

TECHNICAL SPECIFICATION

You can select from a choice of diesel or petrol engines. These engines are designed for clean and efficient combustion and are all equipped with Stop/Start technology.

ENGINES			2.0 LITRE 4-CYLINDER RWD TURBOCHARGED DIESEL		20d 2.0 LITRE 4-CYLINDER RWD TURBOCHARGED DIESEL		20d 2.0 LITRE 4-CYLINDER AWD TURBOCHARGED DIESEL							
Capacity	cc		1,999		1,999		1,999							
Maximum power	EEC-PS (kW)		163 (120)		180 (132)		180 (132)							
@rev/min	rpm		4,000		4,000		4,000							
Maximum torque	EEC-Nm (lb.ft.)		380 (280)		430 (317)		430 (317)							
@rev/min	rpm		1,750-2,500		1,750-2,500		1,750-2,500							
No. of cylinders/Valves per cylinder			4/4		4/4		4/4							
Cylinder layout			Inline		Inline		Inline							
Bore/stroke	(mm)		83.0/92.35		83.0/92.35		83.0/92.35							
Compression ratio	(:1)		15.5 +/- 0.5		15.5 +/- 0.5		15.5 +/- 0.5							
FUEL ECONOMY			Manual		Auto		Auto							
Fuel tank capacity - useable litres			60		60		60							
Diesel Exhaust Fluid (DEF) - useable litres			17		17		17							
Diesel/Gasoline Particulate Filter (DPF/GPF)			●		●		●							
FUEL ECONOMY - NEDC EQUIVALENT [NEDCeq]*			Class A		Class B		Class A		Class B					
NEDCeq CO ₂ Emissions	Combined	(g/km)	140		144		146		150		151		155	
FUEL ECONOMY - WLTP**			TEL - TEH†		TEL - TEH†		TEL - TEH†		TEL - TEH†		TEL - TEH†		TEL - TEH†	
WLTP Consumption	Low	mpg (l/100km)	38.1 - 34.6 (7.4 - 8.2)		35.1 - 32.3 (8.0 - 8.8)		32.8 - 30.8 (8.6 - 9.2)		32.8 - 30.8 (8.6 - 9.2)		32.8 - 30.8 (8.6 - 9.2)		32.8 - 30.8 (8.6 - 9.2)	
	Medium	mpg (l/100km)	47.7 - 42.5 (5.9 - 6.7)		46.5 - 41.6 (6.1 - 6.8)		43.6 - 39.4 (6.5 - 7.2)		43.6 - 39.4 (6.5 - 7.2)		43.6 - 39.4 (6.5 - 7.2)		43.6 - 39.4 (6.5 - 7.2)	
	High	mpg (l/100km)	54.3 - 48.9 (5.2 - 5.8)		53.6 - 48.5 (5.3 - 5.8)		49.2 - 44.3 (5.7 - 6.4)		49.2 - 44.3 (5.7 - 6.4)		49.2 - 44.3 (5.7 - 6.4)		49.2 - 44.3 (5.7 - 6.4)	
	Extra High	mpg (l/100km)	44.7 - 40.8 (6.3 - 6.9)		44.8 - 40.8 (6.3 - 6.9)		40.1 - 36.6 (7.0 - 7.7)		40.1 - 36.6 (7.0 - 7.7)		40.1 - 36.6 (7.0 - 7.7)		40.1 - 36.6 (7.0 - 7.7)	
	Combined	mpg (l/100km)	46.8 - 42.3 (6.0 - 6.7)		45.8 - 41.6 (6.2 - 6.8)		41.9 - 38.3 (6.7 - 7.4)		41.9 - 38.3 (6.7 - 7.4)		41.9 - 38.3 (6.7 - 7.4)		41.9 - 38.3 (6.7 - 7.4)	

Class A (18" and 19" wheels) Class B (20", 21" and 22" wheels)

*The figures provided are NEDCeq calculated from official manufacturer's WLTP tests in accordance with EU legislation. For comparison purposes only. Real world figures may differ. CO₂ and fuel economy figures may vary according to wheel fitment and optional extras fitted. NEDCeq are figures calculated using a Government formula from WLTP figures equivalent to what they would have been under the old NEDC test. The correct tax treatment can then be applied. **WLTP is the new official EU test used to calculate standardised fuel consumption and CO₂ figures for passenger cars. It measures fuel, energy consumption, range and emissions. This is designed to provide figures closer to real-world driving behaviour. It tests vehicles with optional equipment and with a more demanding test procedure and driving profile.

25d 2.0 LITRE 4-CYLINDER TWIN TURBOCHARGED DIESEL		30d 3.0 LITRE V6 TWIN TURBOCHARGED DIESEL		25t 2.0 LITRE 4-CYLINDER TURBOCHARGED PETROL		30t 2.0 LITRE 4-CYLINDER TURBOCHARGED PETROL		5.0 LITRE V8 SUPERCHARGED PETROL	
1,999		2,993		1,997		1,997		5,000	
240 (177)		300 (221)		250 (184)		300 (221)		550 (405)	
4,000		4,000		5,500		5,500		6,000-6,500	
500 (368)		700 (516)		365 (269)		400 (295)		680 (502)	
1,500-2,500		1,500-1,750		1,300-4,500		1,500-4,500		2,500-5,500	
4/4		6/4		4/4		4/4		8/4	
Inline		Longitudinal		Inline		Inline		Longitudinal	
83.0/92.35		84.0/90.0		83.0/92.29		83.0/92.29		92.5/ 93.0	
15.5 +/- 0.5		16.1		10.5 +/-0.5		9.5 +/-0.5		9.5	
Auto		Auto		Auto		Auto		Auto	
60		66		82		82		82	
17		17		-		-		-	
●		●		●		●		●	
Class A	Class B	Class A	Class B	Class A	Class B	Class A	Class B	Class B	Class B
166	171	166	170	172	175	179	182	182	272
TEL - TEH[†]		TEL - TEH[†]		TEL - TEH[†]		TEL - TEH[†]		TEH[†]	
30.1 - 28.5 (9.4 - 9.9)		30.4 - 27.5 (9.3 - 10.3)		23.5 - 21.7 (12.0 - 13.0)		22.1 - 20.9 (12.8 - 13.5)		15.4 (18.3)	
42.1 - 37.3 (6.7 - 7.6)		40.6 - 37.0 (7.0 - 7.6)		31.9 - 29.2 (8.9 - 9.7)		30.3 - 27.9 (9.3 - 10.1)		23.2 (12.2)	
47.5 - 42.7 (6.0 - 6.6)		45.2 - 41.3 (6.2 - 6.8)		36.1 - 32.7 (7.8 - 8.6)		34.8 - 32.1 (8.1 - 8.8)		26.2 (10.8)	
40.5 - 36.6 (7.0 - 7.7)		35.1 - 33.5 (8.0 - 8.4)		29.7 - 27.3 (9.5 - 10.3)		29.1 - 26.5 (9.7 - 10.7)		23.7 (11.9)	
40.8 - 37.0 (6.9 - 7.6)		37.9 - 35.2 (7.4 - 8.0)		30.7 - 28.2 (9.2 - 10.0)		29.6 - 27.3 (9.5 - 10.4)		22.6 (12.5)	

[†]TEL (Test Energy Low) and TEH (Test Energy High) figures are shown as a range under WLTP testing measures. TEL refers to the lowest/most economical figures (with the lightest set of options). TEH refers to the highest/least economical figures (with the heaviest set of options). WLTP legislation dictates that where there is <5g CO₂ variance between TEL and TEH, only the TEH is declared.

JAGUAR F-PACE

TECHNICAL SPECIFICATION



Configure your vehicle at jaguar.com

PERFORMANCE	2.0 LITRE 4-CYLINDER RWD TURBOCHARGED DIESEL [163PS]	20d 2.0 LITRE 4-CYLINDER RWD TURBOCHARGED DIESEL [180PS]	20d 2.0 LITRE 4-CYLINDER AWD TURBOCHARGED DIESEL [180PS]
Acceleration (secs) 0-60mph (0-100 km/h)	9.6 (10.2)	8.1 (8.6)	8.4 (9.0)
Maximum speed mph (km/h)	121 (195)	129 (208)	129 (208)
BRAKES			
Front type		Single Piston Sliding Caliper, Vented Disc	
Front diameter (mm)	325	325	325
Rear type		Single Piston Sliding Caliper, Vented Disc	
Rear diameter (mm)	325	325	325
Park Brake		iEPB, motor on caliper	
WEIGHTS [kg]*			
Unladen weight (EU)**	1,760	1,790	1,845
Unladen weight (DIN)†	1,685	1,715	1,770
Gross Vehicle Weight (GVW)	2,380	2,380	2,460
TOWING [kg]			
Unbraked trailer	750	750	750
Maximum towing	1,600	2,400	2,400
Maximum coupling point (nose weight)	100	100	100
Maximum vehicle and trailer combination (Gross Train Weight)	3,980	4,780	4,860
ROOF CARRYING [kg]			
Maximum roof load (including cross bars)	75	75	75

*Weights reflect vehicles to standard specifications. Optional extras increase weight. **Includes a 75kg driver, full fluids and 90% fuel. †Includes full fluids and 90% fuel. **With 18" wheels fitted.

25d 2.0 LITRE 4-CYLINDER TWIN TURBOCHARGED DIESEL [240PS]	30d 3.0 LITRE V6 TWIN TURBOCHARGED DIESEL [300PS]	25t 2.0 LITRE 4-CYLINDER TURBOCHARGED PETROL [250PS]	30t 2.0 LITRE 4-CYLINDER TURBOCHARGED PETROL [300PS]	5.0 LITRE V8 SUPERCHARGED PETROL [550PS]
6.8 (7.2)	6.2 (6.4)	6.6 (7.0)	5.8 (6.1)	4.1 (4.3)
135 (217)	137 (220)**/ 150 (241)	135 (217)	137 (220)**/145 (233)	176 (283)
Single Piston Sliding Caliper, Vented Disc				
325	350	325	350	4-piston aluminium monobloc fixed caliper, Vented 2-piece disc 395
Single Piston Sliding Caliper, Vented Disc				
325	325	325	325	Single Piston Sliding Caliper, Vented 2-piece disc 396
iEPB, motor on caliper				
1,880	1,954	1,831	1,842	2,070
1,805	1,879	1,756	1,767	1,995
2,470	2,570	2,460	2,460	2,550
750	750	750	750	750
2,400	2,400	2,400	2,400	2,400
100	100	100	100	100
4,870	4,970	4,860	4,860	4,950
75	75	75	75	75

DIMENSIONS

Vehicle Height

1,666mm (1,670mm on SVR)

Headroom

Maximum front/rear headroom with

Panoramic roof fitted 978/952mm

Maximum front/rear headroom with

standard roof 1,007mm/977mm

Legroom

Maximum front legroom 1,023mm

Maximum rear legroom 944mm

Loadspace Capacity

Height 748mm, Width 1,253mm

Loadspace width between arches 1,050mm

Maximum loadspace volume behind first row

Dry* 715 litres, Wet** 1,099 litres

Maximum loadspace volume behind second row

Dry* 385 litres, Wet** 650 litres



*Dry: Volume as measured with VDA-compliant solid blocks (200mm x 50mm x 100mm).

**Wet: Volume as measured by simulating the loadspace filled with liquid.

Dimensions were measured with vehicle at unladen weight.

Turning Circle
Kerb-to-kerb 11.59 metres
Turns lock to lock 2.5



