

The Caddy Brochure

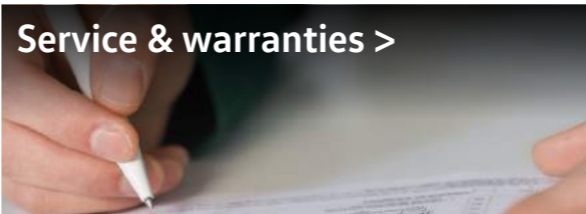

Commercial
Vehicles

Contents

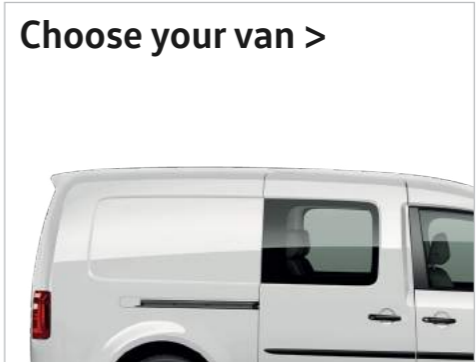
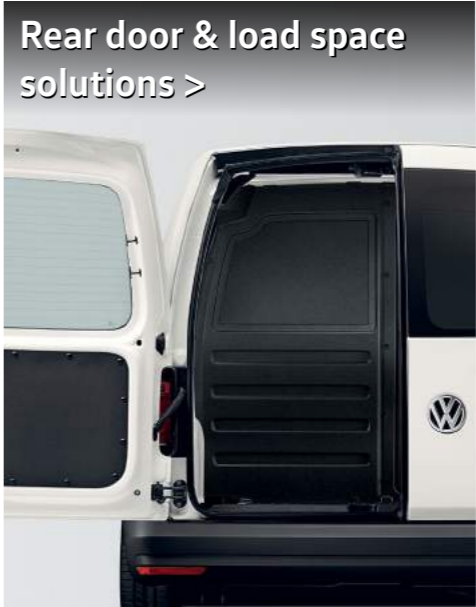
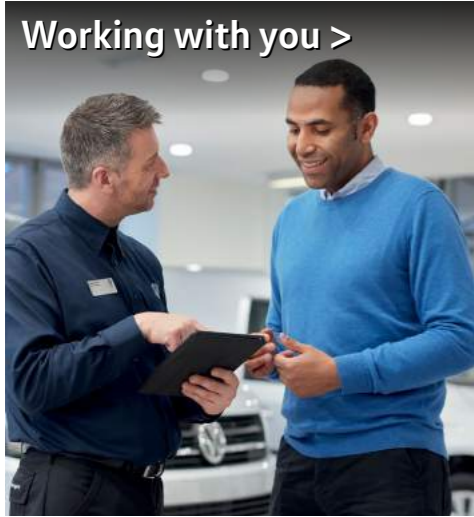

Volkswagen Commercial Vehicles' Van Centres. Working with you.

It's more than a van to you. You're more than a customer to us. We know that when you choose Volkswagen Commercial Vehicles, you're looking for more than just four walls on four wheels. You want a van that looks after itself while you take care of business. A vehicle that makes a statement, as well as a delivery. An investment for the future that makes a difference today.

To us, you're a partner. By being there to get to know how you work and what you need, we can offer you more – supporting your plans year after year. It means a partnership that lasts as long as your ownership, with a vehicle and a team that's with you for the journey.

Our dedicated network of Van Centres. Over **70 Van Centres** and **24 Authorised Repairers** means you're only around 45 minutes on average from our door.



Everything for the job... ..and the journey.

The right van. We're commercial vehicle experts and finding the right van for your business is what makes us tick. We'll guide you through the range, take you on a test drive and cover all the options.

The right accessories. From mudflaps to sat navs, plying to roof racks, we'll work with you to create the perfect van – keeping everything 100% Volkswagen to aid high residuals.

The right finance. Every business is different, so we stay flexible, with a range of finance packages to choose from. Depending on your preference, we'll go through the options to find the one that suits you best.

The right support. Nothing matters more than keeping you mobile, so our servicing options are built around you. You'll also enjoy three-years' free Roadside Assistance with your new van.

The right service. We understand it's the little things that make the difference, so we set high standards. We'll call you when we say, keep you informed on delivery dates and support you long after purchase.

And there's more... We offer a lot more than you might think. From **cost-effective van rental** or an **air conditioning recharge**, to a wide selection of premium and budget **replacement tyres**, if we're not able to help, we'll try and point you in the right direction!

For more information on accessories, finance, service, support and warranties, please refer to the Service and warranties section.





Model shown is Caddy with black commercial exterior mirrors available as a no cost option.

Bold. Sharp. Dynamic. Design.

The Caddy exudes the highest levels of competence and dependability. It's focused in every way – no more so than through it's dynamic exterior styling. While the front delivers a bold stance, the rear features sharp design and elegantly sculptured rear light clusters. Additional highlights include a chrome strip on the radiator grille, stylish side indicators and a range of attractive alloy wheels.



Optional tinted rear tail lights.



Stylish side indicators.



Optional Bi-xenon headlights.

Quality. Function. Convenience. Interior.

The Caddy has a car-like dashboard with a super high-quality finish. To assist your working day you'll discover plenty of ingenious storage solutions, ergonomic seating and a broad selection of radio and infotainment systems – including DAB+ radio and Bluetooth® as standard. With front seat occupants benefitting from electrically heated and adjustable wing mirrors, electric windows, front and curtain airbags as standard, it's a safe and convenient place to spend your working day. Add these ingredients together and the Caddy's interior moves comfort and style to a whole new level.



Standard generous above-cab storage shelf.

Radio and infotainment.

Radio and navigation.

The latest-generation devices are available, including the standard Composition Colour touch-screen DAB+ radio system, optional Composition Media DAB+ radio system, as well as the Discover Media navigation system which is standard on Highline and optional on all other models.

App-Connect.

Available as an option, App-Connect allows you to operate special apps. The screen of your smartphone can be shown on the radio system's display.

Connectivity package.

Available as an option, external media devices, such as MP3 players, can be connected via the USB port. Additionally, the standard mobile phone interface offers a Bluetooth® hands-free speaking system.



Optional App-Connect system.



Electrically heated and adjustable door mirrors.

Open storage compartment with optional 12V socket.

Air conditioning. Standard on Trendline and Highline. Optional on all other models.

Upper storage compartment.

All-round air ventilation.

Lockable glove compartment.

Electric front windows.

Composition Colour DAB+ radio system.

Leather multi-function steering wheel.

12V socket.

Austin cloth upholstery.

Your safety is our priority.

Safety systems.

Your safety is vital, so we ensure that a long list of safety and security features are built into every vehicle we produce. Since we first introduced structural safety features on commercial vehicles over 35 years ago, Volkswagen has maintained a policy of continuous safety development. Every Volkswagen model incorporates a range of both active and passive safety features, to help ensure the safety and security of both you and your load.

With the vehicle's design contributing to safety, occupants are securely enclosed within a rigid safety cell with crumple zones to absorb crash energy, while the chassis and suspension are designed for excellent directional stability and handling. Features such as Anti-lock Braking System (ABS), Electronic Brakeforce Distribution (EBD), Electronic Stabilisation Programme (ESP), driver and passenger front and curtain airbags, electric seatbelt tensioners and Automatic Post-Collision Braking System are fitted as standard.

For additional security and protection, an electronic immobiliser and remote central locking with dead locking and internal locking button are standard, while optional features such as anti-theft devices, front and rear parking sensors, Bi-xenon headlights, automatic rain-sensing wipers and front fog lights with integrated cornering lights all offer additional peace-of-mind.



Model shown is Caddy Maxi kombi with black commercial exterior mirrors available as a no cost option.



Automatic Post-Collision Braking System.
Standard on all Caddy models, it triggers braking after a collision, with the aim of preventing secondary collisions.



Electronic Stabilisation Programme (ESP).
Designed to prevent the vehicle from swerving in critical driving conditions by controlled and targeted intervention in the brake and engine management. This helps to maximise directional stability.



Anti-lock Braking System (ABS).
Designed to prevent wheels from locking up and assist manoeuvrability of the vehicle under heavy braking.



Traction Control System (TCS).
Aids smooth starts and acceleration by reducing wheel-spin. The system also incorporates the Electronic Differential Lock (EDL) and makes up part of the Electronic Stabilisation Programme (ESP).



Electronic Differential Lock (EDL).
Allows smooth starts on slippery or loose road surfaces. If one wheel starts to spin, EDL is designed to brake the wheel as necessary, directing power to the wheel with greater traction.



Airbags.
Driver and passenger front and curtain airbags are standard. They offer occupants improved protection in the event of head-on or side impacts.



Seatbelt warning.
The seatbelt warning reminds the driver that their seatbelt is not fastened. Audio and visual signals are used to request that the seatbelt is fastened before driving.

[Watch video >](#)



Automatic Post-Collision Braking System.
Standard on all Transporter models, it triggers braking after a collision, with the aim of preventing secondary collisions.

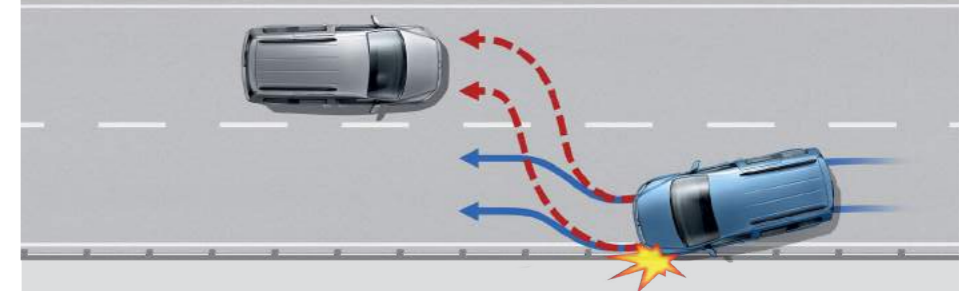

Innovative. Intelligent. Intuitive.

Driver assistance systems.







To help ensure every journey ends as stress-free as it begins, the Caddy is equipped with a number of systems – all of which are activated in critical situations as a preventative measure. Add to this a variety of innovative driver assistance systems and you'll discover the Caddy offers high levels of safety and peace-of-mind.



Optional Park Assist display.



Optional rear-view camera display.

<p> Cruise control including speed limiter. Available as an option, cruise control maintains the selected speed, or limits the top speed, to a value set by the driver.</p>	<p> Brake Assist. Fitted as standard, the system registers the speed at which the brake pedal is pressed. During emergency braking, it helps ensure full brake pressure is applied more quickly.</p>	<p> Hill Hold Assist. Fitted as standard, the convenient Hill Hold Assist helps to prevent your vehicle from rolling back when pulling away on an incline. The hold operates for approximately two seconds.</p>
<p> Driver Alert System. Available as an option, the Driver Alert System registers deviation from normal steering patterns and uses visual and acoustic warnings to recommend that the driver takes a break.</p>	<p> Daytime running lights. Fitted as standard, daytime running lights offer increased visibility. For extra driver convenience, the dipped beam headlights are automatically switched on when you start your vehicle.</p>	<p> Tyre pressure monitoring. The optional tyre pressure monitoring display (standard on kombi) activates a warning signal to highlight significant changes in tyre pressure. This lets the driver know that the tyre pressure should be checked as soon as possible.</p>

An intelligent driving experience. Assistance when you need it.

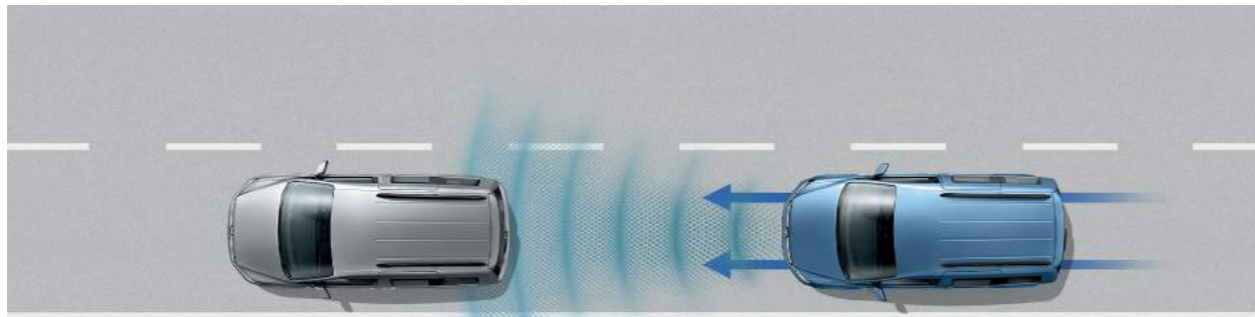

Front Assist with City Emergency Braking System.

Standard Front Assist area monitoring system with City Emergency Braking System detects critical distances, warns of hazardous situations and when necessary, triggers emergency braking.



Adaptive Cruise Control (ACC).

Available as an option, ACC uses a front radar to measure the distance (up to 120m) and speed relative to vehicles driving ahead. It automatically regulates the pre-set distance.

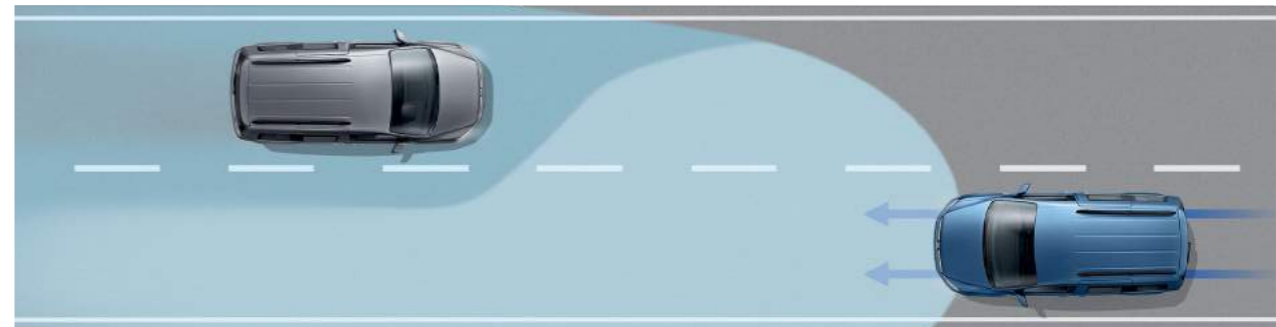

High Beam Assist.

Available as an option, High Beam Assist automatically dips the headlights and prevents dazzle for oncoming vehicles, or vehicles travelling ahead. At night time at speeds of above 37mph, the system automatically switches the headlights to high-beam.

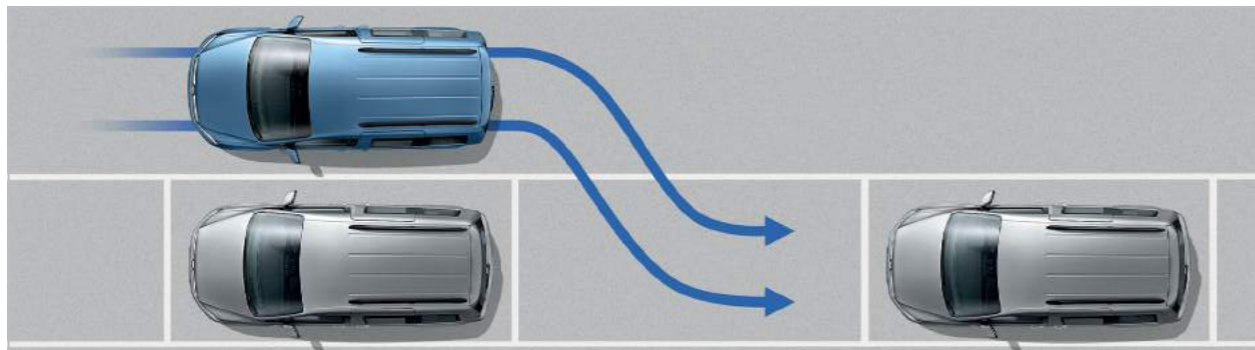

Park Assist.

This useful option aids positioning into parking spaces. When reverse is engaged, the vehicle assumes control of the steering. All that's required of the driver is to operate the clutch, accelerator and brake pedals.

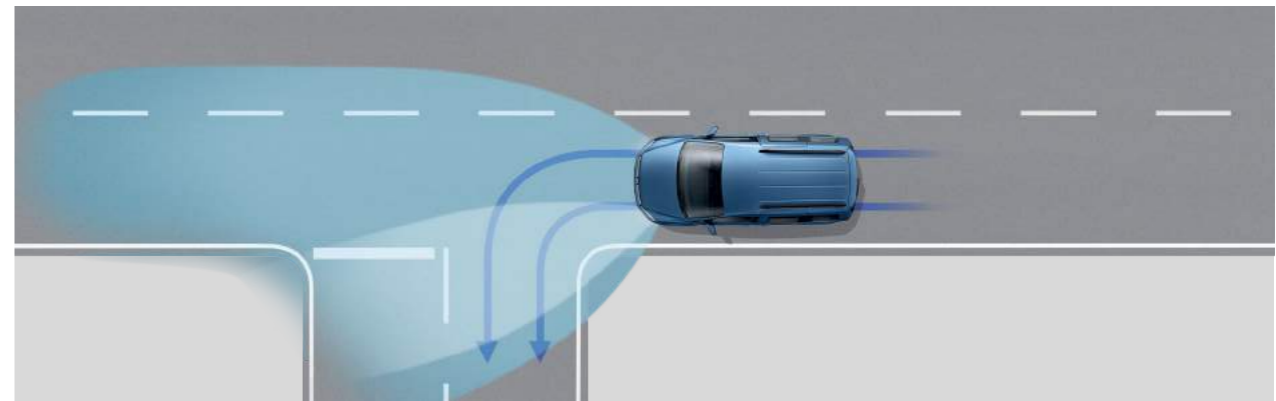

Fog lights with integrated cornering lights.

Available as an option, these help to illuminate curves and bends in the road ahead. This aids the driver in spotting any obstacles where the vehicle is turning.

Access made easy.

Rear door solutions.

Load. Unload. The doors of a commercial vehicle are opened and closed repeatedly throughout the course of a working day. That's why the Caddy is built with hinges, rails and handles that are designed for hard work. We also know that flexibility is important, so the rear of the Caddy is available with a choice of configurations to suit the needs of your particular business. Whether you choose the standard glazed asymmetric rear wing doors with heated windows and wash-wipe, or a glazed or unglazed tailgate with a stylish integrated rear spoiler and soft-touch operation, you'll find a low load bed, combined with a generous opening width of 1,181mm and height of 1,129mm, which helps to make load access easy and convenient.



Asymmetric rear wing doors with windows. Standard on Caddy panel van.



Asymmetric rear wing doors with opaque windows. Standard on Caddy Maxi panel van.

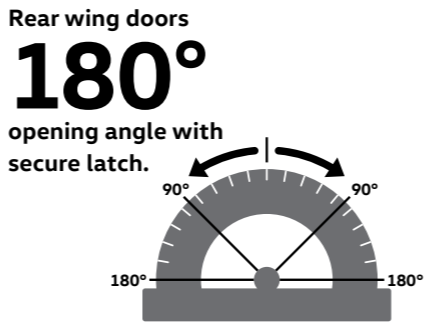

Asymmetric rear wing doors with optional white ABS protective panels.



Tailgate with window and spoiler. Standard on Caddy Maxi kombi and optional on panel vans.



Optional metal tailgate with spoiler.



Versatility. Flexibility. Choice.
Load space solutions.

All Caddy models provide a spacious load compartment that can be tailored to your needs. The standard specification includes multiple load-lashing rings (six on Caddy and eight on Caddy Maxi), painted load floors on panel vans and rubber floor coverings on the kombi. With a range of optional bulkheads, robust load floor coverings, storage solutions, ventilation and electrical upgrades – not to mention our range of Volkswagen accessory 'Add Ons', any Caddy can be specified to suit your requirements.

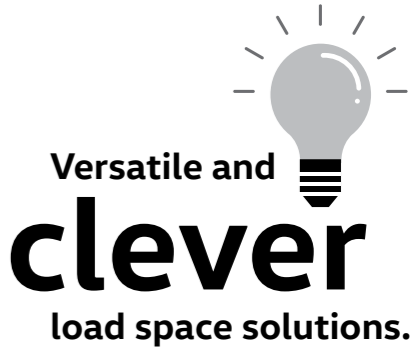

Full-height solid bulkhead. Standard on Caddy Maxi panel van.



Optional rubber load floor covering. Standard on Caddy Maxi kombi.



Multiple load-lashing rings.



Optional load compartment ventilation.

So which model do you need? Choose your van.

Your van.

You probably already have an idea about what you need from your ideal van and what you'll need to carry. Likewise, you're sure to have an idea about what's the heaviest, tallest, widest or longest load you'll need to get into your vehicle. If you're a Fleet Manager, then you'll probably need a variety of options and more than one vehicle. Bearing these factors in mind, the information featured here is designed to help as a quick guide to which vehicle may be the closest match to your own specific requirements.

Your trimline.

For added choice, there's a variety of trimlines available, each delivering its own distinct feel. From the robust Startline to the luxurious Highline, you're sure to find a vehicle and trimline combination that not only works hard, but also creates the right impression.

Your choice.

And remember, that's not all. Every Caddy is available with a wide range of options and accessories – all designed to further help tailor your vehicle to your own particular needs. So which model do you need?

How to select your van:

1. Think about the **maximum length and height** of your load. This will help you choose either a Caddy or Caddy Maxi. If you need to carry more than one passenger, you'll need to consider choosing a Caddy Maxi kombi.
2. Consider your **payload** ranges and think about the heaviest load you need to carry. This will help you to check that your choice is suitable.
3. If you've chosen a Caddy or Caddy Maxi, decide on your preferred **trimline**.
4. Take a look at the separate Caddy price list to discover which **engines and options** are available for your chosen van.

For further information about weights and dimensions data, please refer to the Technical information section. Please note: The kombi's load dimensions vary slightly from the above panel van figures.

Caddy panel van.

[Watch video >](#)

Load length: 1,779mm
Load height: 1,244mm
Payload: 545-734kg

3.2m³
load area volume.

Trimlines:
Startline, Trendline, Highline

Engines:
TDI: 102PS, 150PS
TSI: 102PS

Caddy Maxi panel van.



Load length: 2,249mm
Load height: 1,259mm
Payload: 700-736kg

4.2m³
load area volume.

Trimlines:
Startline, Trendline, Highline

Engines:
TDI: 102PS, 150PS
TSI: 102PS

Caddy Maxi kombi.



Load length: 1,566mm
Load height: 1,240mm
Payload: 631-637kg

4.1m³
maximum load area volume.
1.6m³ load volume
with rear seats in-place.

Engines:
TDI: 102PS
TSI: 102PS

Exterior dimensions.

1,836mm - maximum roof height.



4,408mm - Caddy length.

4,878mm - Caddy Maxi and Caddy Maxi kombi length.

Our range of **spacious** compact vans.



Model shown is Caddy with black commercial exterior mirrors available as a no cost option.

Stylish. Agile. Compact.

Caddy panel van.

Starting from **£15,735†**

Please click here for more details.

So much more than just a stylish, agile, compact and well-built delivery van, the Caddy panel van delivers space in abundance. With a load volume of 3.2m³, it easily carries weights of up to 734kg¹ and accommodates a load length of 1,779mm, load width of 1,556mm (1,170mm between the wheel arches) and load height of 1,244mm. Access at the rear is through two asymmetric wing doors, while a tailgate can be specified as an option. Side access is through a near-side sliding door, which when open, allows a width of 701mm and height of 1,097mm. If required, an off-side sliding door can be specified as an option, allowing for easy access to both sides of the vehicle.



2
Up to side sliding doors.

¹ For further information about weights and dimensions data, please refer to the Technical information section.



Model shown is Caddy with black commercial exterior mirrors available as a no cost option.

Volkswagen Commercial Vehicles may change RRP's at any time (this includes where there are government changes in regulation and/or legislation). There may be a delay to any RRP displaying correctly on our materials. Always obtain prices from your chosen authorised Van Centre.

† Basic RRP excluding VAT.

Working with you	Design	Interior	Assistance systems	Rear door & load space solutions	Choose your van	Caddy panel van	Caddy Maxi panel van	Startline	Trendline	Highline	Caddy Maxi kombi	Paint & upholstery	Wheels	Audio & comms	Technical information	Price list	Offers & finance	Service & warranties
------------------	--------	----------	--------------------	----------------------------------	-----------------	-----------------	----------------------	-----------	-----------	----------	------------------	--------------------	--------	---------------	-----------------------	------------	------------------	----------------------

Delivering space.

Caddy Maxi panel van.

Starting from **£17,330†** [Please click here for more details.](#)

The Caddy Maxi panel van offers many of the same great features as the Caddy panel van, but with the addition of more space. With a load volume of 4.2m³ and a longer wheelbase, the Caddy Maxi provides an additional 1m³ of load volume and an extra 470mm of load length – giving up to 2,249mm of usable space.

In common with the Caddy, access at the rear is through generous asymmetric wing doors, which on the Caddy Maxi, feature opaque glazed panels. When it comes to side access, the Caddy Maxi includes near-side and off-side sliding doors as standard. As an addition to the Caddy, the Caddy Maxi features a full-height solid bulkhead. With eight load-lashing rings, an interior light and hardboard side protection as standard, the Caddy Maxi's load compartment offers the perfect environment for your cargo.

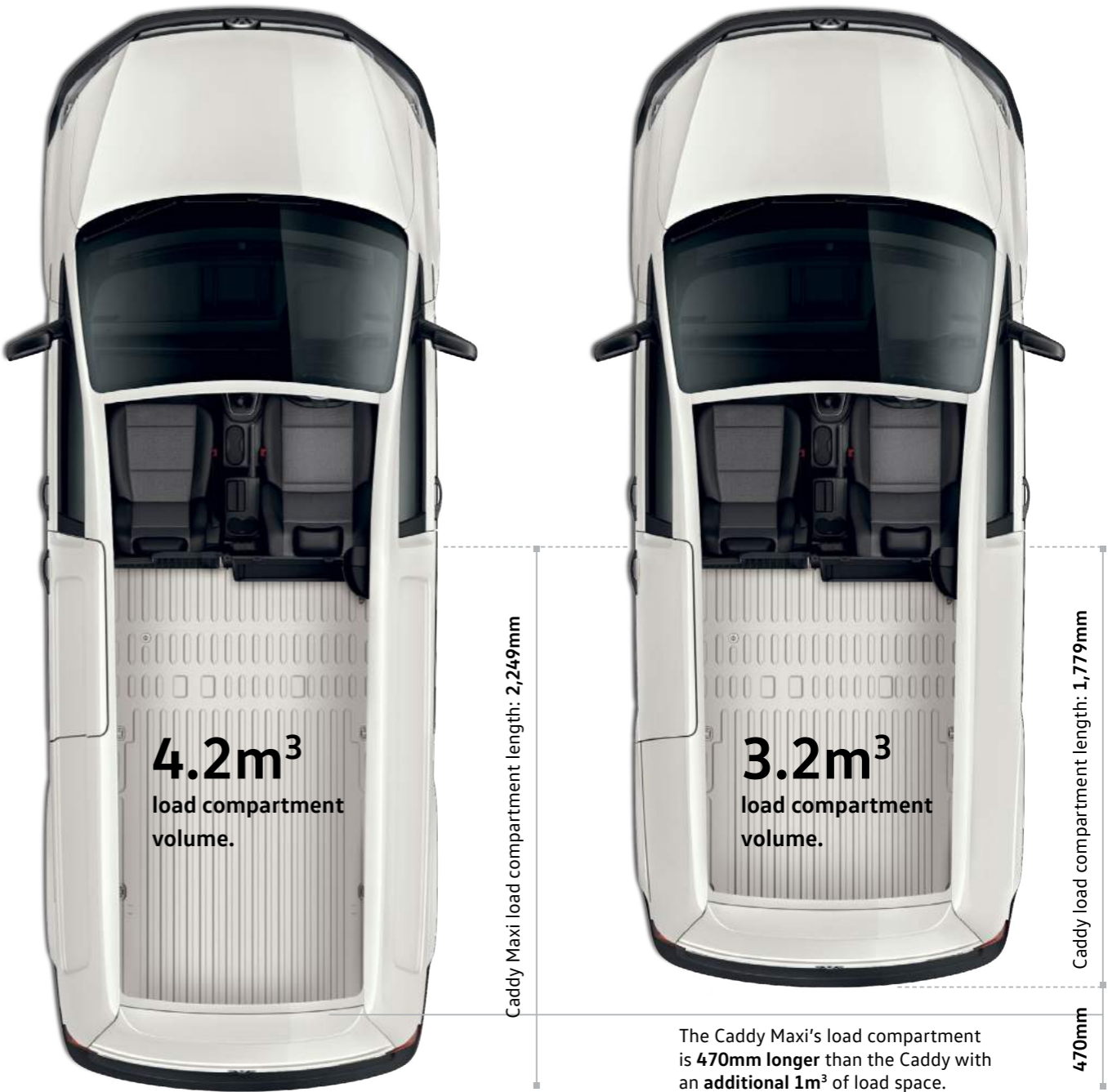
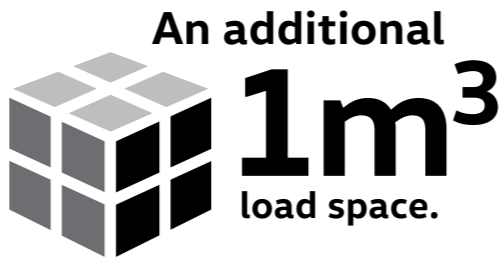

The Caddy Maxi's load compartment is **470mm longer** than the Caddy with an **additional 1m³** of load space.

Volkswagen Commercial Vehicles may change RRP's at any time (this includes where there are government changes in regulation and/or legislation). There may be a delay to any RRP displaying correctly on our materials. Always obtain prices from your chosen authorised Van Centre.
 † Basic RRP excluding VAT.

Working with you	Design	Interior	Assistance systems	Rear door & load space solutions	Choose your van	Caddy panel van	Caddy Maxi panel van	Startline	Trendline	Highline	Caddy Maxi kombi	Paint & upholstery	Wheels	Audio & comms	Technical information	Price list	Offers & finance	Service & warranties
----------------------------------	------------------------	--------------------------	------------------------------------	--	---------------------------------	---------------------------------	---	---------------------------	---------------------------	--------------------------	----------------------------------	--	------------------------	-----------------------------------	---------------------------------------	----------------------------	--------------------------------------	--

Choose your trimline. Startline equipment.

Starting from **£15,735†** [Please click here for more details.](#)

Once you've found your ideal van – or indeed vans if you're a fleet customer, the next step is to choose your perfect trimline. Both the Caddy and Caddy Maxi have a choice of three levels (**Startline, Trendline and Highline**) – each with their own particular strengths and all designed to create the right impression for your business.

Audio and communications.

Composition Colour DAB+ radio including AUX-IN, SD card slot, USB port, Bluetooth®, MP3 compatible CD player and two speakers.

Multi-function display plus.

Cab area.

Austin cloth upholstery.

Digital clock.

Dimmable dashboard illumination.

Door mirrors – electrically heated and adjustable.

Driver's seat with height, reach and rake adjustment.

Electric front windows.

Four drinks holders and storage compartment in centre console.

Glovebox – lockable with illumination.

Interior light in headliner incorporating LED technology.

Leather multi-function steering wheel.

Manually controlled heating system with dust and pollen filter and air recirculation.

Passenger seat with reach and rake adjustment.

Reach and rake adjustable steering column.

Rear-view mirror with anti-dazzle function (Caddy).

Rubber floor covering.

Servotronic speed-related power-assisted steering.

12V socket.

Cargo area.

Full-height bulkhead – solid lower with mesh upper (Caddy).

Full-height bulkhead – solid (Caddy Maxi and C20+).

Hardboard roof trim and painted half-height side panels (with Metallic paint option only).

Heavy-duty suspension (C20+).

Load-lashing rings – six on Caddy, eight on Caddy Maxi.

Two door-activated interior lights.

Two LED spotlights in the cargo area section.

Exterior.

Asymmetric rear wing doors with heated rear window and wash-wipe (Caddy).

Asymmetric rear wing doors with opaque windows (Caddy Maxi and C20+).

Black passenger car style door mirrors and handles.

Black front and rear bumpers.

Heat insulating windscreen.

Roof rail preparation.

Single near-side sliding door (Caddy).

Twin near-side and off-side sliding doors (Caddy Maxi).

Wheels and tyres.

15" steel wheels. 6J x 15 with 195/65 R15 tyres (102PS).

Black wheel centre caps.

Full size steel spare wheel.

Tool kit and jack.

Safety and security.

Anti-lock Braking System (ABS).

Automatic hazard light activation under emergency braking.

Automatic Post-Collision Braking System.

Brake Assist.

Driver Alert System.

Driver and passenger front and curtain airbags.

Electric seatbelt tensioners.

Electronic Brakeforce Distribution (EBD).

Electronic Differential Lock (EDL).

Electronic Stabilisation Programme (ESP).

Engine Drag Torque Control (MSR).

Front Assist with City Emergency Braking System.

Halogen main headlights with range control and daytime running lights.

Height-adjustable head restraints.

Remote central locking with deadlocks, interior locking and two remote keys.

Seatbelt warning when not engaged.

Thatcham Category 2 approved immobiliser.

Traction Control System (TCS).

Windscreen wiper with variable intermittent delay and wash-wipe system.

Efficiency technology.

Hill Hold Assist.

Low rolling resistance tyres.

Regenerative braking.

Start/Stop.

Upgrade your new Caddy Startline panel van with a Business Pack and save **£555.†**

† Saving against the cost of purchasing individual items.

- Anti-theft alarm with interior monitoring, back-up horn and towing protection
- Climatic air conditioning system
- Rear parking sensors

[Find out more](#)

FOR ONLY **£995** + VAT



Volkswagen Commercial Vehicles may change RRP's at any time (this includes where there are government changes in regulation and/or legislation). There may be a delay to any RRP displaying correctly on our materials. Always obtain prices from your chosen authorised Van Centre.

† Basic RRP excluding VAT.

Equipment in addition to Startline. Trendline equipment.

The **Trendline** equipment builds upon the strengths of the Startline by offering a wide range of stylish, practical and technological items. By selecting the most popular options available and combining them into one handy pack, the Trendline offers amazing value when compared to ordering each item individually.

Cab area.

- Climatic air conditioning.
- Cruise control with speed limiter.
- Height adjustment for driver and front passenger seats.
- Storage compartments under driver and front passenger seats.
- Twin sun visors with vanity mirrors.
- 8-way adjustability on driver's seat, including lumbar support.



01 **Multi-function display.** Displays a variety of standard and optional information and assistance systems.

Exterior.

- Body-coloured bumpers, passenger car style door mirrors and handles.
- Rear parking sensors.

Wheels and tyres.

- 15" full wheel trims. 6J x 15 with 195/65 R15 tyres (102PS).



- 02 **15" full wheel trims.** A stylish addition delivering increased exterior style. Standard on 102PS models.
- 03 **Climatic air conditioning.** Delivers a temperature controlled environment.

Starting from **£18,440†** [Please click here for more details.](#)

Unladen weight, payload, fuel consumption and CO₂ emissions may be influenced by trimline, factory options and Van Centre fitted accessories. Volkswagen Commercial Vehicles may change RRP's at any time (this includes where there are government changes in regulation and/or legislation). There may be a delay to any RRP displaying correctly on our materials. Always obtain prices from your chosen authorised Van Centre.

† Basic RRP excluding VAT.

Equipment in addition to Trendline. Highline equipment.

The luxurious **Highline** adds to the Trendline's already impressive specification and offers the perfect balance of comfort and style in a hard-working vehicle. Choose a Highline and you'll have a van that's designed to help get your business noticed.

Audio and communications.

Discover Media satellite navigation system featuring increased touch-screen size of 6.33" with proximity sensor, USB port, Bluetooth®, SD card slot x2, AUX-IN interface, MP3 and WMA compatible CD drive.

Cab area.

Lights & Vision pack – including auto-dimming rear-view mirror, rain sensor with automatic wipers and intermittent control.

Exterior.

Front fog lights.

Heated windscreen.

Safety and security.

Thatcham Category 1 approved immobiliser.

Wheels and tyres.

15" Caloundra alloy wheels. 6J x 15 with 195/65 R15 tyres (102PS).

16" Bendigo alloy wheels. 6J x 16 with 205/55 R16 tyres (150PS).

Locking wheel bolts.

Model shown features body-coloured commercial exterior mirrors available as a no cost option.

Unladen weight, payload, fuel consumption and CO₂ emissions may be influenced by trimline, factory options and Van Centre fitted accessories.

Volkswagen Commercial Vehicles may change RRP's at any time (this includes where there are government changes in regulation and/or legislation). There may be a delay to any RRP displaying correctly on our materials. Always obtain prices from your chosen authorised Van Centre.

† Basic RRP excluding VAT.

Starting from **£19,995†** [Please click here for more details.](#)



01 Discover Media satellite navigation system. Includes free updates for the pre-installed European map.

02 Lights & Vision pack. Includes the convenient auto-dimming rear-view mirror and rain sensor.

03 16" Caloundra alloy wheels. Standard on 102PS models.

04 16" Bendigo alloy wheels. Standard on 150PS models.

Perfect for crew and cargo alike.

Caddy Maxi kombi.

Starting from
£18,810†

Please click here for more details.

The Caddy Maxi kombi offers versatility when you need the ability to transport a crew of up to five (including the driver) and their kit. While the cab includes the usual features you'd expect from any Caddy, behind the cab there's seating for three passengers, consisting of a single seat to the left and dual seat to the right – each fitted with 3-point seatbelts and height-adjustable head restraints. Access to the passenger seating is through twin glazed side sliding doors, while at the rear you'll find a glazed tailgate with heated window and wash-wipe.

Featuring a robust rubber floor covering throughout the cab and cargo area, as well as four load-lashing rings in the cargo area, its flexible interior can be transformed in seconds from a comfortable five-seater, into a spacious delivery van. With the rear seats in place, there is a load volume of 1.6m³, folding the seats forward increases this to 3.9m³, while if you remove the seats, load volume increases to 4.1m³ – only slightly less than the cavernous Caddy Maxi panel van.

The kombi's flexible passenger compartment.



Standard five-seat layout.



2nd row single seat removed.



2nd row dual seat removed.



2nd row seats folded.



2nd row seats removed.

The versatility to
adapt
to your needs.

Upgrade your new Caddy Maxi kombi with a Business Pack and save £555.‡

‡ Saving against the cost of purchasing individual items.

- Anti-theft alarm with interior monitoring, back-up horn and towing protection
- Climatic air conditioning system
- Rear parking sensors

[Find out more](#)

FOR ONLY
£995
+ VAT



Volkswagen Commercial Vehicles may change RRP's at any time (this includes where there are government changes in regulation and/or legislation). There may be a delay to any RRP displaying correctly on our materials. Always obtain prices from your chosen authorised Van Centre.

† Basic RRP excluding VAT.

Caddy Maxi kombi equipment.

Starting from **£18,810†** [Please click here for more details.](#)

The **Caddy Maxi kombi** includes an impressive range of equipment: intelligent mobile online services while you're on the road; high-quality infotainment systems with their user-friendly operation, good connectivity and sound; as well as the flexible interior for cargo and passengers, it's the perfect choice for your crew and kit.

Audio and communications.

Composition Colour DAB+ radio including AUX-IN, SD card slot, USB port, Bluetooth®, MP3 compatible CD player and two speakers.
Multi-function display plus.

Cab area.

Austin fabric upholstery.
Digital clock.
Dimmable dashboard illumination.
Door mirrors – electrically heated and adjustable.
Driver's seat with height, reach and rake adjustment.
Electric front windows.
Glovebox – lockable with illumination.
Interior light in headliner incorporating LED technology.
Leather multi-function steering wheel.
Manually controlled heating system with dust and pollen filter and air recirculation.
Passenger seat with reach and rake adjustment.
Reach and rake adjustable steering column.
Rear-view mirror with anti-dazzle function.
Rubber floor covering.
Servotronic speed-related power-assisted steering.
12V socket.

Passenger/cargo area.

Hardboard roof trim and painted half-height side panels (Metallic paint models only).
Load-lashing rings.
Rubber floor covering.
Three-seat bench in second row – split tipping, folding and removable with ISOFIX mountings to outer seats.
Two door-activated interior lights.

Exterior.

Black passenger car style door mirrors and handles.
Black front and rear bumpers.
Fixed windows in near-side and off-side sliding doors in load/passenger compartment.
Heat insulating windscreen.
Roof rail preparation.
Tailgate with heated window and wash-wipe.
Twin near-side and off-side sliding doors.

Wheels and tyres.

16" full wheel trims. 6J x 16 with 205/55 R16 tyres.
Full size steel spare wheel.
Tool kit and jack.

Efficiency technology.

Hill Hold Assist.
Low rolling resistance tyres.
Regenerative braking.
Start/Stop.

Safety and security.

Anti-lock Braking System (ABS).
Automatic hazard light activation under emergency braking.
Automatic Post-Collision Braking System.
Brake Assist.
Driver Alert System.
Driver and passenger front and curtain airbags.
Electric seatbelt tensioners.
Electronic Brakeforce Distribution (EBD).
Electronic Differential Lock (EDL).
Electronic Stabilisation Programme (ESP).
Engine Drag Torque Control (MSR).
Front Assist with City Emergency Braking System.
Halogen main headlights with range control and daytime running lights.
Height-adjustable head restraints.
Remote central locking with deadlocks, interior locking and one remote key.
Seatbelt warning when not engaged.
Thatcham Category 2 approved immobiliser.
Traction Control System (TCS).
Windscreen wiper with variable intermittent delay and wash-wipe system.

Volkswagen Commercial Vehicles may change RRP's at any time (this includes where there are government changes in regulation and/or legislation). There may be a delay to any RRP displaying correctly on our materials. Always obtain prices from your chosen authorised Van Centre.

† Basic RRP excluding VAT.

Paint & upholstery.

Solid paint.



Candy White



Pure Grey



Cherry Red



Bright Orange



Reflex Silver



Indium Grey

Metallic paint.¹



Sandstorm Yellow



Fortana Red



Blackberry



Chestnut Brown



Viper Green



Starlight Blue

Pearl effect.¹



Acapulco Blue



Deep Black

Upholstery.

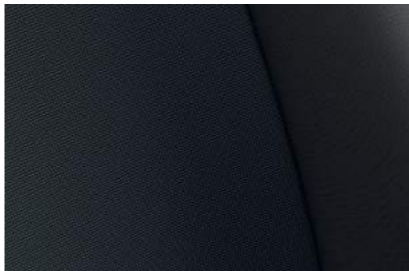

Austin
Titanium Black Cloth
 SL TL HL K

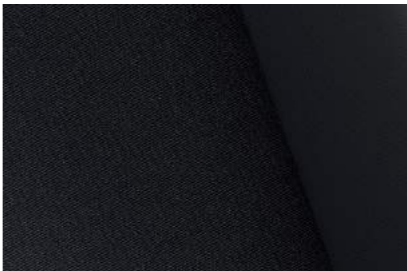

Robust¹
Titanium Black heavy-duty cloth
 SL TL HL

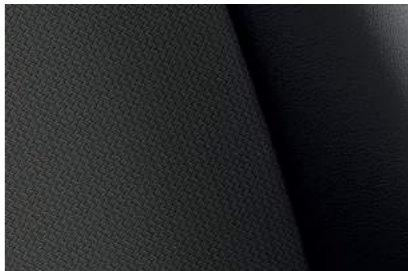

Mesh¹
Titanium Black synthetic leather
 SL TL HL K

¹ Available at extra cost.

Please note: Not all paint and upholstery combinations can be ordered together and in some instances certain combinations may incur extra cost. Not all paint finishes may be available for every trimline. Please check details and availability with your Volkswagen Van Centre at the time of ordering. Screen representations do not allow exact reproduction of paint and upholstery colours.

Standard Optional
SL | Startline TL | Trendline HL | Highline K | Kombi

Wheels.

01 15" wheel trim. Standard on 102PS Trendline.

02 15" Caloundra. 6J x 15 alloy wheels with 195/65 R15 tyres. Standard on 102PS Highline.

03 16" Bendigo. 6J x 16 alloy wheels with 205/55 R16 tyres. Standard on 150PS Highline.

04 16" Fortaleza. 6J x 16 alloy wheels with 205/55 R16 tyres.

05 17" Canyon. Silver/Anthracite. 6J x 17 alloy wheels with 205/55 R17 tyres.



Audio and communications.



01 Composition Colour DAB+ radio system.
Standard on all Caddy models, the Composition Colour DAB+ radio system features a 5" TFT touch-screen colour display, USB port, Bluetooth®, SD card slot, AUX-IN interface, MP3 and WMA compatible CD drive, 4 x 20 watt output with two speakers and a dual tuner with PhaseDiversity for optimum radio reception.

02 Composition Media DAB+ radio system.
The optional Composition Media DAB+ radio system features an increased touch-screen size of 6.33" with proximity sensor, USB port, Bluetooth®, SD card slot, AUX-IN interface, MP3 and WMA compatible CD drive, 4 x 20 watt output with four speakers and a dual tuner with PhaseDiversity for optimum radio reception. App-Connect is available as an option for this system.



03 Discover Media satellite navigation system.
The Discover Media satellite navigation system builds on the strengths of the Composition Media DAB+ radio system by adding satellite navigation and a second integrated SD card slot compatible for map data. The system includes free updates for the pre-installed European maps through Volkswagen MapCare. The Discover Media satellite navigation system is standard on Highline and optional on all other models. App-Connect is available as an option for this system.

04 App-Connect.¹ Available as an option with the Composition Media DAB+ radio system or Discover Media navigation system. App-Connect allows you to operate special apps. The screen of your smartphone can be shown on the radio system's display.

¹ The 'App' control button on the optional Discover Media navigation system is only enabled when ordered in conjunction with the optional App-Connect system.

Diesel engine and gearbox data.

Engine specifications.	2.0TDI 102PS	2.0TDI 150PS
Engine type	Diesel, transverse, water-cooled, in-line, variable turbine geometry turbocharger with intercooler	Diesel, transverse, water-cooled, in-line, variable turbine geometry turbocharger with intercooler
Mixture preparation/injection method	Common-rail, direct injection	Common-rail, direct injection
EU exhaust emission standard	EURO 6D Temp	EURO 6D Temp
Number of cylinders	4	4
Cubic capacity	1,968cc	1,968cc
Output, PS at rpm	102 at 2,900-4,000	150 at 3,500-4,000
Torque, max. Nm at rpm	250 at 1,300-2,800	340 at 1,750-3,000
Fuel tank capacity	60 litre	60 litre
AdBlue® capacity	9 litre	9 litre
Diesel Particulate Filter [DPF]	●	●
5-speed manual gearbox	●	-
6-speed manual gearbox	-	-
6-speed dual clutch gearbox [DSG]	○	●
Front-wheel drive	●	●
Alternator	110A	110A
Battery	61Ah (330A)	61Ah (330A)

● Standard ○ Available - Not available

Petrol engine and gearbox data.

Engine specifications.	1.0TSI 102PS
Engine type	Petrol, transverse, water-cooled, in-line, variable turbine geometry turbocharger with intercooler
Mixture preparation/injection method	Petrol, direct injection
EU exhaust emission standard	EURO 6D Temp
Number of cylinders	3
Cubic capacity	999cc
Output, PS at rpm	102 at 5,000
Torque, max. Nm at rpm	175 at 1,500-3,500
Fuel tank capacity	55 litre
5-speed manual gearbox	●
6-speed manual gearbox	-
7-speed dual clutch gearbox [DSG]	-
Front-wheel drive	●
Alternator	140A
Battery	59Ah (320A)

● Standard ○ Available - Not available

Diesel fuel consumption, performance and emissions.

Engine/transmission	CO ₂ emissions, g/km ¹		Combined fuel consumption mpg ¹		Combined fuel consumption (ltr/100km) ¹		Acceleration, seconds 0 - 62mph	Top speed, mph, (where law permits)
	Max.	Min.	Max.	Min.	Max.	Min.		
C20 Caddy.								
2.0TDI 102PS 5-speed manual	143	141	46.3	49.6	6.1	5.7	12.0	107
2.0TDI 102PS 6-speed DSG	141	137	44.1	47.1	6.4	6.0	12.1	106
2.0TDI 150PS 6-speed DSG	146	139	42.8	45.6	6.6	6.2	9.4	119
C20+ Caddy.								
2.0TDI 102PS 5-speed manual	143	139	46.3	48.7	6.1	5.8	16.6	107
C20 Caddy Maxi.								
2.0TDI 102PS 5-speed manual	146	141	44.8	47.9	6.3	5.9	12.5	107
2.0TDI 102PS 6-speed DSG	141	139	42.8	45.6	6.6	6.2	12.6	106
2.0TDI 150PS 6-speed DSG	146	142	41.5	44.1	6.8	6.4	9.4	119
C20 Caddy Maxi kombi.								
2.0TDI 102PS 5-speed manual	146	143	44.8	47.1	6.3	6.0	12.0	107
2.0TDI 102PS 6-speed DSG	141	139	43.5	44.8	6.5	6.3	12.1	106

¹ These vehicles are WLTP (Worldwide Harmonised Light-Duty Vehicles Test Procedure) type approved vehicles. More information is available at www.volkswagen-vans.co.uk/about-us/wltp. However, to facilitate comparison between different models from different manufacturers and to accommodate the full transition to this new testing regime, we have displayed NEDC figures. These NEDC figures have been derived from WLTP testing, and may not be equivalent to NEDC figures from NEDC testing, so comparisons may be unreliable. Fuel consumption and efficiency figures are provided for comparative purposes only and may not reflect 'real world' driving results. Choice of wheels and other options may affect fuel consumption and emissions data.

Petrol fuel consumption, performance and emissions.

Engine/transmission	CO ₂ emissions, g/km ¹		Combined fuel consumption mpg ¹		Combined fuel consumption (ltr/100km) ¹		Acceleration, seconds 0 - 62mph	Top speed, mph, (where law permits)
	Max.	Min.	Max.	Min.	Max.	Min.		
C20 Caddy.								
1.0TSI 102PS 5-speed manual	141	135	38.2	40.9	7.4	6.9	11.3	107
C20 Caddy Maxi.								
1.0TSI 102PS 5-speed manual	141	137	37.2	39.8	7.6	7.1	10.8	107
C20 Caddy Maxi kombi.								
1.0TSI 102PS 5-speed manual	141	139	37.2	39.2	7.6	7.2	12.5	107

¹ These vehicles are WLTP (Worldwide Harmonised Light-Duty Vehicles Test Procedure) type approved vehicles. More information is available at www.volkswagen-vans.co.uk/about-us/wltp. However, to facilitate comparison between different models from different manufacturers and to accommodate the full transition to this new testing regime, we have displayed NEDC figures. These NEDC figures have been derived from WLTP testing, and may not be equivalent to NEDC figures from NEDC testing, so comparisons may be unreliable. Fuel consumption and efficiency figures are provided for comparative purposes only and may not reflect 'real world' driving results. Choice of wheels and other options may affect fuel consumption and emissions data.

Diesel weights.

Engine/transmission	Gross vehicle weight ¹ , kg	Axle load limit, front/rear, kg	Trailer weight braked 12%/unbraked, kg	Gross train weight, kg	Unladen weight ² , kg	Payload ³ , kg	Unladen weight ² , kg	Payload ³ , kg	Unladen weight ² , kg	Payload ³ , kg
C20 Caddy.					Startline.		Trendline.		Highline.	
2.0TDI 102PS 5-speed manual	2,161	1,075 / 1,230	1,500 / 690	3,650	1,491	670	1,509	652	1,514	647
2.0TDI 102PS 6-speed DSG	2,197	1,100 / 1,230	1,500 / 710	3,697	1,527	670	1,545	652	1,550	647
2.0TDI 150PS 6-speed DSG	2,201	1,100 / 1,230	1,500 / 710	3,701	-	-	-	-	1,554	647
C20+ Caddy.					Startline.					
2.0TDI 102PS 5-speed manual	2,231	1,075 / 1,250	1,500 / 690	3,650	1,493	738				
C20 Caddy Maxi.					Startline.		Trendline.		Highline.	
2.0TDI 102PS 5-speed manual	2,319	1,150 / 1,300	1,500 / 740	3,650	1,582	737	1,600	719	1,605	714
2.0TDI 102PS 6-speed DSG	2,346	1,175 / 1,300	1,500 / 750	3,800	1,618	728	-	-	1,641	705
2.0TDI 150PS 6-speed DSG	2,353	1,150 / 1,300	1,500 / 750	3,800	-	-	-	-	1,648	705
C20 Caddy Maxi kombi.					Maxi kombi.					
2.0TDI 102PS 5-speed manual	2,310	1,200 / 1,250	1,500 / 750	3,650	1,676	634				
2.0TDI 102PS 6-speed DSG	2,359	1,200 / 1,250	1,500 / 750	3,800	1,715	644				

1 These vehicles are WLTP (Worldwide Harmonised Light-Duty Vehicles Test Procedure) type approved vehicles. More information is available at www.volkswagen-vans.co.uk/about-us/wltp. However, to facilitate comparison between different models from different manufacturers and to accommodate the full transition to this new testing regime, we have displayed NEDC figures. These NEDC figures have been derived from WLTP testing, and may not be equivalent to NEDC figures from NEDC testing, so comparisons may be unreliable. Fuel consumption and efficiency figures are provided for comparative purposes only and may not reflect 'real world' driving results. Choice of wheels and other options may affect fuel consumption and emissions data.

2 Unladen weight includes approximately 90% fuel load and 75kg for driver.

3 Payload = gross vehicle weight minus unladen weight. Quoted weights are for vehicles with standard specification. Unladen weight and payload may be influenced by trimline, factory options and Van Centre fitted accessories. Roof load limit: 100kg. Trailer nose weight: 80kg.

Petrol weights.

Engine/transmission	Gross vehicle weight ¹ , kg	Axle load limit, front/rear, kg	Trailer weight braked 12%/unbraked, kg	Gross train weight, kg	Unladen weight ² , kg	Payload ³ , kg	Unladen weight ² , kg	Payload ³ , kg	Unladen weight ² , kg	Payload ³ , kg
C20 Caddy.					Startline.		Trendline.		Highline.	
1.0TSI 102PS 5-speed manual	2,046	1,050 / 1,230	1,200 / 640	3,200	1,376	670	-	-	-	-
C20 Caddy Maxi.					Startline.		Trendline.		Highline.	
1.0TSI 102PS 5-speed manual	2,203	1,050 / 1,300	1,200 / 680	3,200	1,466	737	-	-	-	-
C20 Caddy Maxi kombi.					Maxi kombi.					
1.0TSI 102PS 5-speed manual	2,254	1,150 / 1,230	1,200 / 710	3,200	1,560	694	-	-	-	-

1 These vehicles are WLTP (Worldwide Harmonised Light-Duty Vehicles Test Procedure) type approved vehicles. More information is available at www.volkswagen-vans.co.uk/about-us/wltp. However, to facilitate comparison between different models from different manufacturers and to accommodate the full transition to this new testing regime, we have displayed NEDC figures. These NEDC figures have been derived from WLTP testing, and may not be equivalent to NEDC figures from NEDC testing, so comparisons may be unreliable. Fuel consumption and efficiency figures are provided for comparative purposes only and may not reflect 'real world' driving results. Choice of wheels and other options may affect fuel consumption and emissions data.

2 Unladen weight includes approximately 90% fuel load and 75kg for driver.

3 Payload = gross vehicle weight minus unladen weight. Quoted weights are for vehicles with standard specification. Unladen weight and payload may be influenced by trimline, factory options and Van Centre fitted accessories. Roof load limit: 100kg. Trailer nose weight: 80kg.

Dimensions.

Caddy panel van.

Wheelbase		2,682
Load compartment	length	1,779
	width	1,556
	width between wheel arches	1,170
	height	1,244
	load volume	3.2m ³
Side sliding door	width	701
	height	1,097
Rear wing doors	width	1,183
	height	1,134
Turning circle (wall to wall)		11.1m

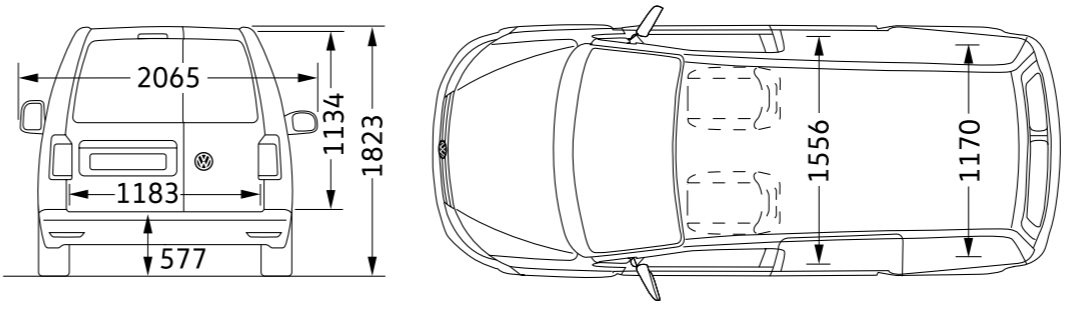
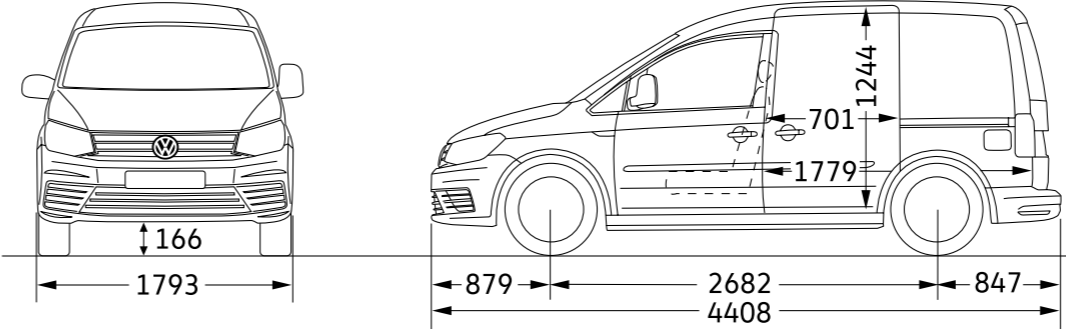

Caddy Maxi panel van.

Wheelbase		3,006
Load compartment	length	2,249
	width	1,552
	width between wheel arches	1,168
	height	1,259
	load volume	4.2m ³
Side sliding door	width	701
	height	1,097
Rear wing doors	width	1,183
	height	1,134
Turning circle (wall to wall)		12.2m

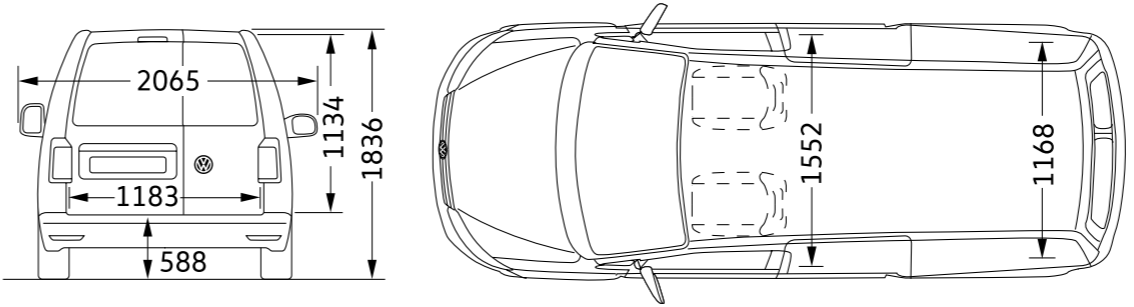
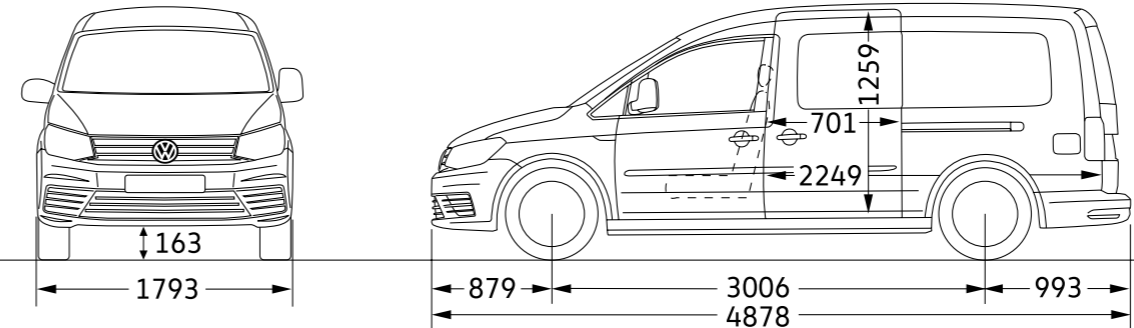

Please note: Vehicle drawings are not to scale. All dimensions in millimetres (mm), unless otherwise stated. The height measurements listed may vary by ± 50mm depending on model and equipment fitted.

Dimensions (continued).

Caddy Maxi kombi.

Wheelbase		3,006
Load compartment	length	1,823
	width	1,190
	width between wheel arches	1,168
	height	1,240
Load volume	rear seats upright	1.6m ³
	rear seats folded	3.9m ³
	rear seats removed	4.1m ³
Side sliding door	width	701
	height	1,084
Rear tailgate	width	1,183
	height	1,134
Turning circle (wall to wall)		12.2m

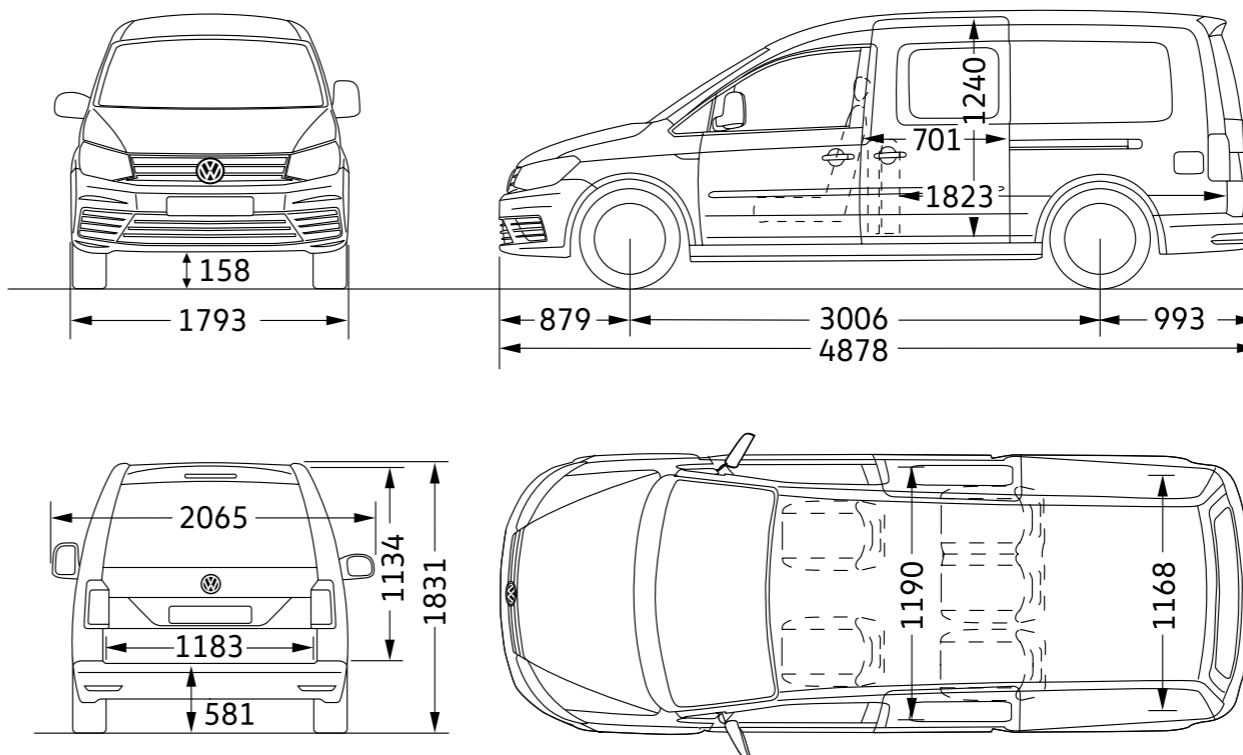

Please note: Vehicle drawings are not to scale. All dimensions in millimetres (mm), unless otherwise stated. The height measurements listed may vary by ± 50mm depending on model and equipment fitted.

Price list.



Upgrade your new Caddy Startline panel van with a Business Pack and save £555.*

* Saving against the cost of purchasing individual items.

- Anti-theft alarm with interior monitoring, back-up horn and towing protection
- Climatic air conditioning system
- Rear parking sensors

[Find out more](#)

FOR ONLY
£995
+ VAT



*Manufacturer's on the road (OTR) package.

Delivery to Van Centre	£620.00
Number plates	£20.00
VAT	£128.00
First registration fee	£55.00
Vehicle excise duty (VED) 1st year	£260.00
Basic OTR price (exc. VAT)	£955.00
Total OTR price (inc. VAT)	£1,083.00

Volkswagen Commercial Vehicles may change RRP's at any time (this includes where there are government changes in regulation and/or legislation). There may be a delay to any RRP displaying correctly on our materials. Always obtain prices from your chosen authorised Van Centre.

Model prices – Caddy panel van.

Trimline	Model	Engine/transmission	Basic exc. VAT	Total inc. VAT	Total RRP inc. OTR* exc. VAT	Total RRP inc. OTR* inc. VAT
Startline diesel	C20	2.0TDI 102PS 5-speed manual	£16,820.00	£20,184.00	£17,775.00	£21,267.00
		2.0TDI 102PS 6-speed DSG	£18,440.00	£22,128.00	£19,395.00	£23,211.00
	C20+	2.0TDI 102PS 5-speed manual	£16,970.00	£20,364.00	£17,925.00	£21,447.00
Startline petrol	C20	1.0TSI 102PS 5-speed manual	£15,735.00	£18,882.00	£16,690.00	£19,965.00
Trendline diesel	C20	2.0TDI 102PS 5-speed manual	£18,440.00	£22,128.00	£19,395.00	£23,211.00
		2.0TDI 102PS 6-speed DSG	£20,060.00	£24,072.00	£21,015.00	£25,155.00
Highline diesel	C20	2.0TDI 102PS 5-speed manual	£19,995.00	£23,994.00	£20,950.00	£25,077.00
		2.0TDI 102PS 6-speed DSG	£21,615.00	£25,938.00	£22,570.00	£27,021.00
		2.0TDI 150PS 6-speed DSG	£23,900.00	£28,680.00	£24,855.00	£29,763.00

* Please click here for more details on manufacturer's on the road (OTR) package.

Volkswagen Commercial Vehicles may change RRP's at any time (this includes where there are government changes in regulation and/or legislation). There may be a delay to any RRP displaying correctly on our materials. Always obtain prices from your chosen authorised Van Centre.

Upgrade your new Caddy Startline panel van with a Business Pack and save £555.*

* Saving against the cost of purchasing individual items.

- Anti-theft alarm with interior monitoring, back-up horn and towing protection
- Climatic air conditioning system
- Rear parking sensors

[Find out more](#)

FOR ONLY
£995
+ VAT



Model prices – Caddy Maxi panel van.

Trimline	Model	Engine/transmission	Basic exc. VAT	Total inc. VAT	Total RRP inc. OTR* exc. VAT	Total RRP inc. OTR* inc. VAT
Startline diesel	C20	2.0TDI 102PS 5-speed manual	£18,415.00	£22,098.00	£19,370.00	£23,181.00
		2.0TDI 102PS 6-speed DSG	£20,035.00	£24,042.00	£20,990.00	£25,125.00
Startline petrol	C20	1.0TSI 102PS 5-speed manual	£17,330.00	£20,796.00	£18,285.00	£21,879.00
Trendline diesel	C20	2.0TDI 102PS 5-speed manual	£20,035.00	£24,042.00	£20,990.00	£25,125.00
Highline diesel	C20	2.0TDI 102PS 5-speed manual	£21,590.00	£25,908.00	£22,545.00	£26,991.00
		2.0TDI 102PS 6-speed DSG	£23,210.00	£27,852.00	£24,165.00	£28,935.00
		2.0TDI 150PS 6-speed DSG	£25,495.00	£30,594.00	£26,450.00	£31,677.00

* Please click here for more details on manufacturer's on the road (OTR) package.

Volkswagen Commercial Vehicles may change RRP's at any time (this includes where there are government changes in regulation and/or legislation). There may be a delay to any RRP displaying correctly on our materials. Always obtain prices from your chosen authorised Van Centre.

Model prices – Caddy Maxi kombi.

Trimline	Model	Engine/transmission	Basic exc. VAT	Total inc. VAT	Total RRP inc. OTR* exc. VAT	Total RRP inc. OTR* inc. VAT
Maxi kombi diesel	C20	2.0TDI 102PS 5-speed manual	£19,720.00	£23,664.00	£20,675.00	£24,747.00
		2.0TDI 102PS 6-speed DSG	£21,340.00	£25,608.00	£22,295.00	£26,691.00
Maxi kombi petrol	C20	1.0TSI 102PS 5-speed manual	£18,810.00	£22,572.00	£19,765.00	£23,655.00

* Please click here for more details on manufacturer's on the road (OTR) package.

Volkswagen Commercial Vehicles may change RRP's at any time (this includes where there are government changes in regulation and/or legislation). There may be a delay to any RRP displaying correctly on our materials. Always obtain prices from your chosen authorised Van Centre.

Upgrade your new Caddy Maxi kombi with a Business Pack and save **£555.***

* Saving against the cost of purchasing individual items.

- Anti-theft alarm with interior monitoring, back-up horn and towing protection
- Climatic air conditioning system
- Rear parking sensors

FOR ONLY

£995

+ VAT

[Find out more](#)



Options.

Paint.	PR Code.	Startline.		Trendline.		Highline.		Maxi kombi.	
		Basic exc. VAT	Total RRP inc. VAT	Basic exc. VAT	Total RRP inc. VAT	Basic exc. VAT	Total RRP inc. VAT	Basic exc. VAT	Total RRP inc. VAT
Solid. Bright Orange (E3E3), Candy White (B4B4), Cherry Red (4B4B), Pure Grey (J2J2). Bright Orange is only available on a Startline.	As shown	○	○	○	○	○	○	○	○
Metallic. Acapulco Blue (2W2W), Blackberry (COC0), Chestnut Brown (H4H4), Fortana Red (I9I9), Indium Grey (X3X3), Mojave Beige (1B1B), Reflex Silver (8E8E), Sandstorm Yellow (9U9U), Starlight Blue (3S3S), Viper Green (6B6B).	As shown	£440.00	£528.00	£440.00	£528.00	£440.00	£528.00	£440.00	£528.00
Pearl effect. Deep Black (2T2T).	As shown	£440.00	£528.00	£440.00	£528.00	£440.00	£528.00	£440.00	£528.00
Customised. Please contact your local Van Centre for availability.	-	From £115.00	From £138.00	-	-	-	-	From £115.00	From £138.00
Upholstery.									
Seat trim covers in Mesh leatherette.	ZS2	£60.00	£72.00	£60.00	£72.00	£60.00	£72.00	£60.00	£72.00
Seat trim covers in Austin fabric.	N2D	●	●	●	●	●	●	●	●
Seat trim covers in Robust fabric.	N1C	£50.00	£60.00	£50.00	£60.00	£50.00	£60.00	-	-
Interior trim.									
Titanium Black/Titanium Black – Titanium Black/Black. Seats in Titanium/Dashboard upper in Titanium Black – lower in Titanium Black/Floor covering in Black.	DM	●	●	●	●	●	●	●	●

● Standard – Not available ○ At no extra cost Where additional equipment is required by chosen options, additional equipment will be charged at the prices shown.

Please note: Not all paint and upholstery combinations can be ordered together and in some instances certain combinations may incur extra cost.

Not all paint finishes may be available for every trimline. Please check details and availability with your Volkswagen Van Centre at the time of ordering.

Volkswagen Commercial Vehicles may change RRP's at any time (this includes where there are government changes in regulation and/or legislation). There may be a delay to any RRP displaying correctly on our materials. Always obtain prices from your chosen authorised Van Centre.

Options (continued).

Seating.	PR Code.	Startline.		Trendline.		Highline.		Maxi kombi.	
		Basic exc. VAT	Total RRP inc. VAT	Basic exc. VAT	Total RRP inc. VAT	Basic exc. VAT	Total RRP inc. VAT	Basic exc. VAT	Total RRP inc. VAT
Heated driver's and front passenger's seats.	4A3	£260.00	£312.00	£260.00	£312.00	£260.00	£312.00	£260.00	£312.00
Lumbar support for driver and front passenger seats.	7P4	£145.00	£174.00	£80.00	£96.00	£80.00	£96.00	£145.00	£174.00
Lumbar support for driver's seat.	7P6	£80.00	£96.00	●	●	●	●	£80.00	£96.00
Wheels and tyres.									
16" Bendigo alloy wheels. 6J x 16 205/55 R16 94H.	ZRD	£940.00	£1,128.00	£890.00	£1,068.00	-	-	£940.00	£1,128.00
102PS		£940.00	£1,128.00	£890.00	£1,068.00	£380.00	£456.00	£940.00	£1,128.00
150PS		£940.00	£1,128.00	£890.00	£1,068.00	●	●	£490.00	£588.00
16" Fortaleza alloy wheels. 6J x 16 205/55 R16 94H.	ZC6	£940.00	£1,128.00	£890.00	£1,068.00	-	-	£940.00	£1,128.00
102PS		£940.00	£1,128.00	£890.00	£1,068.00	£380.00	£456.00	£940.00	£1,128.00
150PS		£940.00	£1,128.00	£890.00	£1,068.00	○	○	-	-
17" Canyon alloy wheels, Anthracite. 6J x 17 205/50 R17 93H.	ZC7	-	-	-	-	£850.00	£1,020.00	-	-
16" All-weather tyres. 205/55 R16 94H. Only in combination with a 16" alloy wheel or 16" full wheel trims at an additional cost.	J19	£125.00	£150.00	£125.00	£150.00	£125.00	£150.00	£125.00	£150.00
Wheel and tyre accessories.									
Tyre mobility kit in lieu of spare wheel.	1G8	○	○	○	○	○	○	○	○

● Standard - Not available ○ At no extra cost Where additional equipment is required by chosen options, additional equipment will be charged at the prices shown.

Volkswagen Commercial Vehicles may change RRP's at any time (this includes where there are government changes in regulation and/or legislation). There may be a delay to any RRP displaying correctly on our materials. Always obtain prices from your chosen authorised Van Centre.

Options (continued).

Audio and communications.	PR Code.	Startline.		Trendline.		Highline.		Maxi kombi.	
		Basic exc. VAT	Total RRP inc. VAT	Basic exc. VAT	Total RRP inc. VAT	Basic exc. VAT	Total RRP inc. VAT	Basic exc. VAT	Total RRP inc. VAT
App-Connect. Only in combination with Composition Media (Z45) or Discover Media navigation system (Z49) at an additional cost.	9WT	£140.00	£168.00	£140.00	£168.00	£140.00	£168.00	£140.00	£168.00
Composition Media DAB+ radio system with 6.33" touch-screen.	Z45	£275.00	£330.00	£275.00	£330.00	-	-	£275.00	£330.00
Discover Media navigation system. Includes Guide and Inform, SD card maps.	Z49	£750.00	£900.00	£750.00	£900.00	●	●	£750.00	£900.00
Driver assistance.									
Adaptive Cruise Control (ACC) including speed limiter.	8T7/8T8	-	-	£295.00	£354.00	£295.00	£354.00	£295.00	£354.00
Cruise control including speed limiter.	8T6	£270.00	£324.00	●	●	●	●	●	●
High Beam Assist. Only in combination with Discover Media Navigation system (Z49) at an additional cost.	8G1	£135.00	£162.00	£135.00	£162.00	£135.00	£162.00	£135.00	£162.00
Parking sensors – rear.	7X1	£290.00	£348.00	●	●	●	●	£290.00	£348.00
Parking sensors – front and rear with Park Assist.	7X5	-	-	£320.00	£384.00	£320.00	£384.00	-	-
Parking sensors – front and rear with rear-view camera and Park Assist. Only in combination with Discover Media Navigation system (Z49) at an additional cost.	7X6	-	-	£555.00	£666.00	£555.00	£666.00	-	-
Parking sensors – rear with rear-view camera. Only in combination with Discover Media Navigation system (Z49) at an additional cost.	7X7	£500.00	£600.00	£230.00	£276.00	£230.00	£276.00	£500.00	£600.00
Rear-view camera without parking sensors. Only in combination with Discover Media Navigation system (Z49) at an additional cost.	7X9	-	-	○	○	○	○	-	-

● Standard – Not available ○ At no extra cost Where additional equipment is required by chosen options, additional equipment will be charged at the prices shown.

Volkswagen Commercial Vehicles may change RRP's at any time (this includes where there are government changes in regulation and/or legislation). There may be a delay to any RRP displaying correctly on our materials. Always obtain prices from your chosen authorised Van Centre.

Options (continued).

Packages.	PR Code.	Startline.		Trendline.		Highline.		Maxi kombi.	
		Basic exc. VAT	Total RRP inc. VAT	Basic exc. VAT	Total RRP inc. VAT	Basic exc. VAT	Total RRP inc. VAT	Basic exc. VAT	Total RRP inc. VAT
Business pack. Includes Anti-theft alarm Thatcham Category 1, interior (cab only) with tow-away protection, rear parking sensors and Climatic air conditioning.	W56	£995.00	£1,194.00	-	-	-	-	£995.00	£1,194.00
Commercial exterior mirrors.	ZAE	○	○	○	○	○	○	○	○
Exterior mirrors – electrically adjustable, heated and power folding. Only in combination with passenger car style exterior mirrors.	ZE2	£110.00	£132.00	£110.00	£132.00	£110.00	£132.00	£110.00	£132.00
Fog lights – front.	8WD	£135.00	£162.00	£135.00	£162.00	●	●	£135.00	£162.00
Fog lights – front with cornering function.	8WH	£230.00	£276.00	£230.00	£276.00	£130.00	£156.00	-	-
Headlights – Bi-xenon with separate LED daytime running lights.	PL8	£690.00	£828.00	£690.00	£828.00	£690.00	£828.00	£690.00	£828.00
Lights & Vision pack. Includes auto-dimming rear-view mirror, automatic headlights with daytime running lights and windscreen wiper with intermittent control and rain sensor.	PL5	£170.00	£204.00	£170.00	£204.00	●	●	£170.00	£204.00
Winter pack. Includes headlight washers, heated washer jets, washer fluid level indicator, heated driver's and front passenger seats and electric auxiliary air heater. Electric auxiliary heater (ATC) is not included with petrol Caddy models.	ZW7	£525.00	£630.00	£525.00	£630.00	£525.00	£630.00	£525.00	£630.00
Without nameplate set.	ONA	○	○	○	○	○	○	○	○

● Standard – Not available ○ At no extra cost Where additional equipment is required by chosen options, additional equipment will be charged at the prices shown.

Volkswagen Commercial Vehicles may change RRP's at any time (this includes where there are government changes in regulation and/or legislation). There may be a delay to any RRP displaying correctly on our materials. Always obtain prices from your chosen authorised Van Centre.

Upgrade with the Business Pack.

We're working with you to help build the perfect Volkswagen Caddy for your business. Available on Caddy Startline panel van and Maxi kombi models, the Business Pack allows you to upgrade with rear parking sensors, air-conditioning and an alarm for as little as £995 +VAT. That's saving you and your business while you drive around in a top-of-the-range Caddy that's more secure, temperature controlled and easy to manoeuvre into those tight spaces.



Options (continued).

Body and chassis.	PR Code.	Startline.		Trendline.		Highline.		Maxi kombi.	
		Basic exc. VAT	Total RRP inc. VAT	Basic exc. VAT	Total RRP inc. VAT	Basic exc. VAT	Total RRP inc. VAT	Basic exc. VAT	Total RRP inc. VAT
Additional front underbody guard.	1SB	£280.00	£336.00	£280.00	£336.00	£280.00	£336.00	-	-
Lowered suspension. SWB Panel van only.	2MH	£220.00	£264.00	£220.00	£264.00	£220.00	£264.00	-	-
Rear wing doors with opaque glass, without heated rear window and wash-wipe. Standard on Maxi panel van.	ZF2	○	○	○	○	○	○	-	-
Rear wing doors with window apertures asymmetrically split. Standard on SWB Panel van.	3RE	○	○	○	○	○	○	○	○
Reinforced cab doors (Hinge).	OD2	£165.00	£198.00	£165.00	£198.00	£165.00	£198.00	-	-
Roof rails – Black.	3S7	£195.00	£234.00	£195.00	£234.00	£195.00	£234.00	£195.00	£234.00
Side sliding door – driver’s side. Additional to standard passenger’s side sliding door.	5R2	£310.00	£372.00	£310.00	£372.00	£310.00	£372.00	●	●
Tailgate without window.	3RB	○	○	○	○	○	○	-	-
Tailgate with window. Only in combination with Climatronic A/C (ZK9) or Rear window (4HM).	3RC	£60.00	£72.00	£60.00	£72.00	£60.00	£72.00	-	-

● Standard – Not available ○ At no extra cost Where additional equipment is required by chosen options, additional equipment will be charged at the prices shown.

Volkswagen Commercial Vehicles may change RRP's at any time (this includes where there are government changes in regulation and/or legislation). There may be a delay to any RRP displaying correctly on our materials. Always obtain prices from your chosen authorised Van Centre.

Options (continued).

Cargo area.	PR Code.	Startline.		Trendline.		Highline.		Maxi kombi.		
		Basic exc. VAT	Total RRP inc. VAT	Basic exc. VAT	Total RRP inc. VAT	Basic exc. VAT	Total RRP inc. VAT	Basic exc. VAT	Total RRP inc. VAT	
Bulkhead – deleted. Not available on C20+ models. Only in combination with LED interior lights in passenger/load compartment.	ZT0	○	○	○	○	○	○	-	-	
Bulkhead – full solid, high without window. Only in combination with Lights & Vision pack or rear-view mirror. Standard on a Maxi Panel van.	3CF	○	○	○	○	○	○	-	-	
Bulkhead – adjustable in load compartment.	YLG	-	-	-	-	-	-	£655.00	£786.00	
Carpet floor covering in cab.	5AD	○	○	○	○	○	○	○	○	
Load compartment floor covering – rubber. SWB Panel van only.	5BS	£120.00	£144.00	£120.00	£144.00	£120.00	£144.00	-	-	
Load compartment floor covering – rubber. Maxi Panel van only.	5BS	£215.00	£258.00	£215.00	£258.00	£215.00	£258.00	-	-	
Heating and ventilation.										
Air conditioning – manual in the cab.	ZK2	See Business Pack offer.	£1,035.00	£1,242.00	●	●	●	●	£1,035.00	£1,242.00
Air conditioning – 2-zone Climate control in the cab. SL – Only in combination with Tailgate with window (3RC) or Rear wing doors with a window (3RE), HL – Only in Combination with Heated driver and front seats (4A3) or Winter pack (ZW7) at an additional cost.	ZK9		£1,215.00	£1,458.00	£255.00	£306.00	£255.00	£306.00	-	-

● Standard – Not available ○ At no extra cost Where additional equipment is required by chosen options, additional equipment will be charged at the prices shown.

Volkswagen Commercial Vehicles may change RRP's at any time (this includes where there are government changes in regulation and/or legislation). There may be a delay to any RRP displaying correctly on our materials. Always obtain prices from your chosen authorised Van Centre.

Options (continued).

Safety and security.	PR Code.	Startline.		Trendline.		Highline.		Maxi kombi.	
		Basic exc. VAT	Total RRP inc. VAT	Basic exc. VAT	Total RRP inc. VAT	Basic exc. VAT	Total RRP inc. VAT	Basic exc. VAT	Total RRP inc. VAT
Anti-theft alarm Thatcham Category 1, interior (cab only) and tow-away protection.	ZQ9	£225.00	£270.00	£225.00	£270.00	●	●	£225.00	£270.00
Two remote control locking keys.	8QJ	●	●	●	●	●	●	£25.00	£30.00
Four remote control keys for locking system.	8QM	£70.00	£84.00	£70.00	£84.00	£70.00	£84.00	£70.00	£84.00
Tyre pressure warning light.	7K1	£55.00	£66.00	£55.00	£66.00	£55.00	£66.00	●	●

See Business Pack offer.

Windows.	PR Code.	Basic exc. VAT	Total RRP inc. VAT	Basic exc. VAT	Total RRP inc. VAT	Basic exc. VAT	Total RRP inc. VAT	Basic exc. VAT	Total RRP inc. VAT
Heated windscreen. Only in combination with Lights and Vision pack (PL5) and if ordered with Climatronic air con (ZK9) then heated driver and front passenger seats (4A3) or Winter pack (ZW7) will also need to be ordered at an additional cost.	4GX	£170.00	£204.00	£170.00	£204.00	●	●	£170.00	£204.00
Privacy glass – rear.	QC1	-	-	-	-	-	-	£165.00	£198.00
Rear windows without heated rear window and wash-wipe.	4HM	○	○	○	○	○	○	-	-
Rear windows replaced with ABS covers. ABS covers available in Candy White (B4B4), Reflex Silver, (8E8E) Deep Black Pearl (2T2T) and Pure Grey (J2J2) only.	4HG	£425.00	£510.00	£425.00	£510.00	£425.00	£510.00	-	-

● Standard – Not available ○ At no extra cost Where additional equipment is required by chosen options, additional equipment will be charged at the prices shown.

Volkswagen Commercial Vehicles may change RRP's at any time (this includes where there are government changes in regulation and/or legislation). There may be a delay to any RRP displaying correctly on our materials. Always obtain prices from your chosen authorised Van Centre.

Finance made simple. As dedicated to finance as we are to your new Caddy.

Learn more about our range of finance products to find a finance package that suits your budget.

Alternatively, 'Click on' the Offers & Finance button above to find out more about our latest offers to help your business thrive.

Cost of your vehicle

Deposit
As little as one monthly repayment

Monthly repayments
Spread across 18 to 49 months

Optional final payment
You have three choices at the end of your agreement



Own
Hire

Solutions Personal Contract Plan

Not sure if you want to own or hire? Make the decision later. Pay monthly payments for the length of your agreement. At the end you can decide to keep (once all payments have been made), upgrade or return the vehicle.

Cost of your vehicle

Deposit
As little as one monthly repayment

Repayments
Spread across 12 to 60 months



Own

Hire Purchase

Make all the regular monthly payments. At the end the vehicles is yours.

Cost of your vehicle

Deposit
As little as one monthly repayment

Rental repayments
Spread across 12 to 48 months

Final 'balloon' repayment



Own

Lease Purchase

Make lower monthly payments by deferring an amount until the end. Once paid the vehicle is yours.

Cost of your vehicle

Initial rental
As little as one rental repayment

Rental repayments
Spread across 12 to 60 months



Hire

Contract Hire

Pay fixed monthly rentals to hire the vehicle. Look after it so at the end you can return it hassle free.

Cost of your vehicle

Initial rental
As little as one rental repayment in advance

Rental repayments
Spread across 12 to 60 months



Hire

Finance Lease (full pay out)

Pay monthly rentals to hire the vehicle. At the end you have two options. Sell the vehicle and receive a percentage of the sale proceeds. Or retain the use of your vehicle by paying a reduced annual rental.

Cost of your vehicle

Initial rental
As little as one rental repayment in advance

Rental repayments
Spread across 12 to 48 months

Final 'balloon' repayment
You have two options at the end of your agreement



Hire

Finance Lease (balloon repayment)

Pay monthly rentals to hire the vehicle. At the end you have two options. Sell the vehicle to settle the outstanding amount and receive any excess sale proceeds. Or pay the 'balloon' payment and retain the use of your vehicle by paying a reduced annual rental.

Finance subject to status. Available to 18s and over in the UK only. Terms and Conditions apply. Volkswagen Commercial Vehicle Financial Services.

Service & warranties.

Finance and insurance.¹

When it comes to paying for your van, we've got options including Contract Hire and Finance Lease, or Hire Purchase. We can also offer you competitive insurance.

A choice of packages.²

Whether you prefer to lease your vehicles, with none of the concerns of ownership and the freedom to change models easily, or purchase outright to own the vehicle that's perfect for your business, we're here to help you consider your options.

You can go flexible, by choosing a payment plan that suits your finances, with options to reduce your monthly costs and your repayment period. Or choose a fixed monthly price that allows you to budget confidently for the longer term.

You can even include your road tax and servicing costs to arrive at one simple, all-inclusive payment. For more information, pick up a finance brochure, or ask at your Van Centre.

Volkswagen insurance.

Volkswagen Commercial Vehicles Insurance¹ provides cost-effective and comprehensive motor insurance³, as well as gap insurance⁴, which helps replace your vehicle and protect you from any financial shortfall if it's written off.

Insurance benefits include:

- Complimentary 5-day drive away insurance cover.
- All repairs performed by approved repairers.
- Volkswagen Genuine Parts[®] used on all repairs.
- Courtesy vehicle provided during repair following an accident (subject to availability).
- Cover for breakage and damage to glass.
- In-vehicle personal belongings cover (up to £250).
- Vehicle recovery.
- 90-day European Union cover.

For more information about our motor insurance call: **0345 877 6355** (lines open 9am-6pm Monday-Friday) or visit: insurewithvwcv.co.uk

Servicing and support.

We're here to keep your business moving, with our range of three award-winning⁵ servicing and maintenance options, as well as free Roadside Assistance. Some exclusions apply. For more detail, please visit www.volkswagen-vans.co.uk/aftersales.

Pay monthly.

This option is available for vehicles that are less than 12 months old and have covered less than 10,000 miles.

It makes budgeting easier by splitting the cost of servicing into fixed monthly payments – whether you want Service only; Service and Maintenance; or Service, Maintenance and Tyres.

Pay upfront.⁶

If you can pay for more than one service upfront, we'll help by reducing your costs. Buy two upfront and you'll receive one interim and one full service at a discounted rate. Buy four and you'll receive two interim and two full services, with your next MOT also included.

Pay on demand.

If you're looking for freedom and flexibility with your servicing, it's good to know we're ready when you are. So with our third option, you can choose to pay for your services as and when you need them, with our National Service Pricing. Ask your Van Centre for an up-to-date pricing guide.

Roadside Assistance.

We understand the need to keep you mobile. That's why all new vans come with three-year, unlimited mileage roadside cover. Should the unexpected happen, one call gets you straight through to a team trained to help you through any breakdown or accident. Supporting you every day will be a team of vehicle technicians, fully-trained by Volkswagen and carrying the latest diagnostic equipment, specialist tools and parts.

Assistance benefits include:

- Assistance at home, by the roadside or place of work.
- Recovery to your preferred location.
- Onward travel, for you and your cargo.
- Cover 24 hours a day, 365 days a year.
- Free cover for three years (on new vehicles).
- Unlimited mileage.
- European cover.
- Option to extend cover beyond three years.

Warranties.

You can count on us long after you purchase your Caddy, thanks to its comprehensive three-year, 100,000 mile warranty. You choose Volkswagen because your business depends on it, year in, year out. While your Caddy is under warranty, we'll fix any defect in manufacture or workmanship free of charge, even if you purchase and service the vehicle at different Van Centres. Some exclusions apply and the vehicle must be cared for using the guidance in your owner's manual. For more detail, please visit www.volkswagen-vans.co.uk/aftersales.

Extended warranty.

You can also extend your warranty beyond the three-year, 100,000 mile period, choosing either Comprehensive or Major Component cover, as a one-off or monthly payment. For more detail of cover levels, along with terms and conditions, please visit volkswagencvwarranty.co.uk where you'll also be able to obtain a quote and purchase an extended warranty.

Paint and body warranty.

Your Caddy's exterior paintwork is covered against manufacturing defects for a period of three years, while its body sections and panels are covered against rusting through from the inside for 12 years. Some exclusions apply and the vehicle must be cared for using the guidance in your owner's manual.

Add Ons

Accessories to help keep your vehicle 100% Volkswagen

Add extra style, protection and practicality to your van, while still keeping it 100% Volkswagen.

Add more with Add Ons...

Accessories allow you to go beyond options and truly customise your van. You might want extra capacity with roof attachments or a tow bar, add cab technology or even convert a work van into a weekend leisure vehicle.

Keep it 100% Volkswagen.

There are big advantages to purchasing approved accessories from us. Add Ons have all been designed with your Volkswagen in mind, so they're a perfect match for fit and style. They're built to be rugged, reliable and long-lasting.

Keep your Add Ons covered.

Most Add Ons include a two-year warranty, but the great news is that if you order and fit them when you purchase a new van, we may be able to extend that to three years to match your vehicle's warranty. Ask your Van Centre for more detail.

- 1 Volkswagen Commercial Vehicles Insurance and Volkswagen Commercial Vehicle Financial Services are trading names of Volkswagen Financial Services (UK) Limited, Brunswick Court, Yeomans Drive, Blakelands, Milton Keynes MK14 5LR, which is authorised and regulated by the Financial Conduct Authority (FCA). Registered in England and Wales No. 2835230. Volkswagen Financial Services (UK) Limited financial services register number is 311988.
- 2 An offer of finance depends on certain conditions. Finance subject to status. Available to 18s and over. Terms and conditions apply. Volkswagen Commercial Vehicle Financial Services.
- 3 Volkswagen Commercial Vehicle Insurance is arranged by U K Insurance Business Solutions Limited and is underwritten by U K Insurance Limited. U K Insurance Business Solutions Limited is authorised and regulated by the Financial Conduct Authority and U K Insurance Limited is authorised by the Prudential Regulation Authority and regulated by the Financial Conduct Authority and the Prudential Regulation Authority. U K Insurance Business Solutions Limited. Registered office: Churchill Court, Westmoreland Road, Bromley, Kent BR1 1DP. Registered in England and Wales No. 05196274. Calls may be recorded.
- 4 Volkswagen Commercial Vehicle Insurance gap insurance is underwritten by MAPFRE Asistencia Compañía Internacional de Seguros y Reaseguros Sociedad Anonima authorised by Dirección General de Seguros y Fondos de Pensiones and subject to limited regulation by the Financial Conduct Authority and Prudential Regulation Authority, number 203041. Details about the extent of their regulation by the Financial Conduct Authority and Prudential Regulation Authority are available on request. MAPFRE Asistencia Compañía Internacional de Seguros y Reaseguros Sociedad Anonima is incorporated and registered in the Kingdom of Spain and registered as a foreign company in the United Kingdom with company number FC021974, acting through its UK branch with branch number BR008042 and whose principal office is at Alpha House, 5th Floor, 24A Lime Street, London EC3M 7HS. Volkswagen Commercial Vehicle Insurance gap insurance is administered by Abraxas Insurance Administration Services Limited, who is authorised and regulated by the Financial Conduct Authority with FCA number 308702 and who acts on behalf of the Insurer. Abraxas Insurance Administration Services Limited is registered in England and Wales with company number: 02928787 and whose registered office is at One Glass Wharf, Bristol BS2 0SX. Volkswagen Financial Services (UK) Limited is authorised and regulated by the Financial Conduct Authority (FCA). Authorisation details can be checked on the Financial Services register at www.fca.org.uk/firms/systems-reporting/register or call 0800 111 6768. Volkswagen Financial Services (UK) Limited is not part of the same corporate group as MAPFRE Asistencia Compañía Internacional de Seguros y Reaseguros Sociedad Anonima and Abraxas Insurance Administration Service Limited.
- 5 Business Vans Awards 2014 and 2015: Best Service Package for Van Owners.
- 6 Class 4 MOT only. This option is available to all new and used vehicles up to four years old or with less than 80,000 miles on the clock. Services must be used consecutively prior to vehicle reaching eight years old.

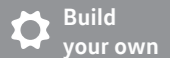

Build
your own



Find a
Van Centre



Test drive



Offers &
Finance



Conversions



Comparator



The Caddy

This brochure supersedes all previous publications.

Issue: 1 November 2019

www.volkswagen-vans.co.uk

Please note: Screen technology does not allow exact reproduction of the paint and upholstery colours. Some of the vehicles shown are European specification and may be fitted with optional equipment or accessories that are available at extra cost, or do not reflect current specification. All data and specifications are in accordance with information available at the time of publication and are subject to change without notice. Vehicles not currently in UK stock and customer order vehicles may take a number of weeks for delivery. Certain combinations of vehicle specifications and factory-fitted options are not compatible and therefore all orders received are subject to confirmation. Models, factory fitted-options and paint and upholstery options are subject to availability. Please check details and availability with an authorised Volkswagen Van Centre at the time of ordering.