

# The Amarok

## Brochure



**WHATCAR?**  
CAR  
OF THE  
YEAR  
2019  
Pick-up  
Winner



Commercial  
Vehicles



# The Amarok.

100% pickup. 100% premium.

# V6

### Perfect for off-road.

Permanent 4MOTION all-wheel drive.

### Optimised safety.

Automatic Post-Collision Braking System utilising 17" disc brakes in the front and 16" disc brakes at rear.

### Load platform surface usage.

Widest load platform in its class and moving tailgate.

### Towing capacity and payload.

Towing load of up to 3.1 tonnes and 1,146kg payload.<sup>1</sup>

### Exterior design.

Styling bar plus<sup>2</sup> and up to 20" alloy wheels.

### Interior design.

Intuitive controls and the only vehicle with 'ergoComfort' seats with 14-way adjustment.<sup>3</sup>

### Modern infotainment systems.

Radio and navigation systems with Car-Net mobile online services.

### V6 3.0 litre TDI engines.

With a power output of up to 258PS and torque of up to 580 Nm.

### Improved transmission.

Permanent 4MOTION all-wheel drive with 8-speed automatic gearbox.

### Fuel-saving technology.

Including start/stop system.



1 Amarok Trendline 3.0 litre V6 TDI 204PS engine, Permanent 4MOTION all-wheel drive with 8-speed automatic transmission.  
2 Optional at extra cost.  
3 Optional on Amarok Highline models.

Please contact your local Volkswagen Commercial Vehicles Van Centre for details of the standard equipment and optional extras available.



# Contents.

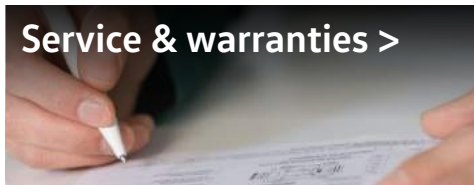
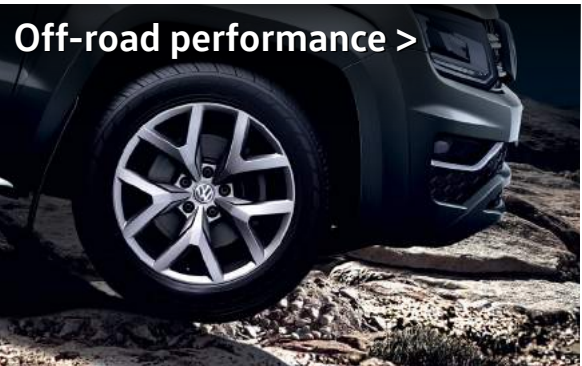
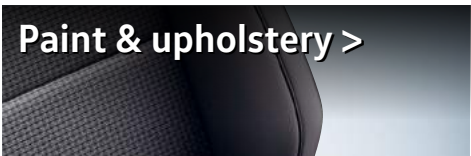
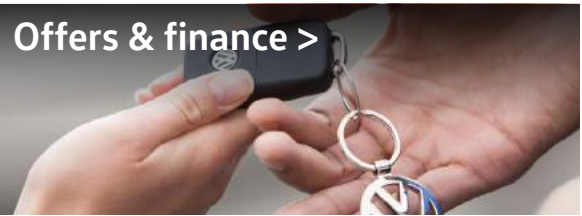
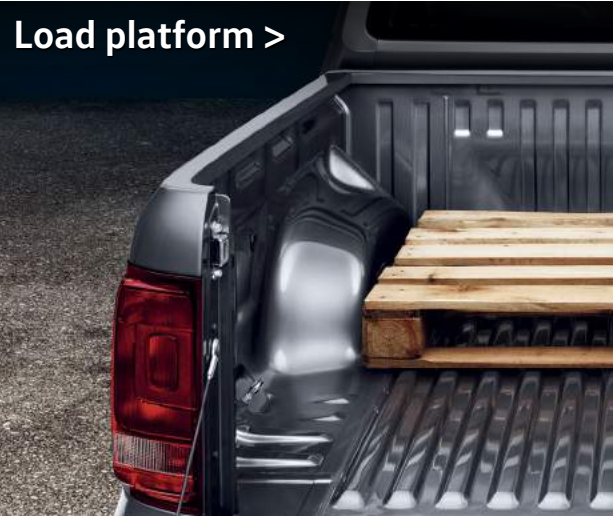



# More dynamic.

Clear lines and bi-xenon headlights.

The Amarok is eye-catching from any angle, with its wide stance and rugged appearance combined with powerful engines, strong chassis and superb interior styling. The chiselled contours and styling highlights exude quality and style, beautifully complemented by the striking rear design, making it as much at home for the family as it is at work.



Please contact your local Volkswagen Commercial Vehicles Van Centre for details of the standard equipment and optional extras available.





# More exclusive.

**Stylish cockpit with premium equipment, intuitive infotainment systems and Car-Net mobile online services.**

The interior provides a convincing combination of space, high comfort and numerous extras. All Amarok models feature as standard, a dash panel with decorative trim, A4 format storage compartment and a leather trimmed multifunction steering wheel. Depending on your choice of model, the Amarok also includes either the Composition Media DAB+ radio system or the Discover Media navigation system.



'App-Connect' is available in conjunction with the Composition Media radio system or the Discover Media navigation systems. 'App-Connect' comprises MirrorLink™, CarPlay™ and Android Auto™. The availability of these technologies may vary depending on the country in question. Please note that 'App-Connect' is not currently supported by every mobile telephone on the market. Volkswagen is working closely with major smartphone producers to promote broader compatibility for 'App-Connect'.





Please contact your local Volkswagen Commercial Vehicles Van Centre for details of the standard equipment and optional extras available.

# More reassuring.

**Equipped with the Automatic Post-Collision Braking System and electronic trailer stabilisation system as standard.**

Safety on almost any terrain: The Amarok is the only pick-up in its class to come with an Automatic Post-Collision Braking System as standard. What's more, the Amarok also features 17" brake discs at the front and 16" brake discs in the rear. Add to that, the trailer stabilisation system which provides the best possible protection against snaking trailers, and it all provides even further peace of mind.

For more information please refer to the Infotainment & assistance systems section.





# More powerful.

## 4MOTION all-wheel drive, off-road ABS and Hill Descent Assist.

The Amarok offers premium driving comfort, even under the toughest of conditions. This is due to the perfect harmony created between the running gear and drive train – combined with the proven and tested 4MOTION all-wheel drive which knows how to pack a punch when it needs to. The outstanding off-road ABS function also helps to reduce braking distances on loose terrain.



The Amarok is the only pickup in its class to offer drivers the luxury of combining the Permanent 4MOTION all-wheel drive with an 8-speed automatic gearbox. The automatic gear-change system increases driving comfort considerably, particularly on challenging terrain or in hilly regions.

Please contact your local Volkswagen Commercial Vehicles Van Centre for details of the standard equipment and optional extras available.





# Off-road performance.

Ready for the challenge.

The Amarok's innovative Permanent 4MOTION all-wheel drive system enables sure-footed progress when you encounter rain, snow, sand, mud or gravel. It's designed to maintain traction while off-road, as well as offering improved road holding and increased safety in poor surface conditions.



01

**01 Permanent 4MOTION all-wheel drive** (not shown). This 4x4 drive system with a self-locking Torsen central differential is unique in the pickup segment and provides a balanced 40:60 distribution for all on-road and off-road tasks.<sup>1</sup> This vehicle also comes into its own on the road by significantly increasing traction when cornering.

**Mechanical differential lock** (not shown). The Amarok is also available with an optional mechanical differential lock which helps provide ideal traction on sandy and slippery terrain. Following activation, both of the rear wheels are powered with even power and even speed.

**Hill Hold Assist** (not shown). This prevents the vehicle from rolling back on inclines and simplifies hill starts.

<sup>1</sup> The distribution varies depending on the surface.

Please contact your local Volkswagen Commercial Vehicles Van Centre for details of the standard equipment and optional extras available.





Outstanding off-road ABS with Hill Descent Assist.

**02 Brakeover angle.** Thanks to increased ground clearance and depending on the loading condition, the Amarok can climb ramps with an angle from 15.6° up to 20.1°. <sup>1</sup>

**04 Ramp angle and wading depth.** The maximum angles of approach and departure for the Amarok is 29.5° at the front and 18.0° at the rear. It also has a wading depth of 500mm.

**03 Gradients.** The Amarok handles inclines up to 45°. <sup>1</sup>

**05 Traverse gradient.** The broad wheelbase of the Amarok provides enormous stability even when traversing slopes with a 50° incline. <sup>1,2</sup>

**06**

**06 Off-road ABS.** Once activated, the wheels lock when braking on loose surfaces with a larger interval, essentially digging the tyres into the surface creating a wedge which significantly reduces the braking distance. This noticeably increases the driving safety.

**06 Hill Descent Assist.** Allows you to drive down slopes in a safe, controlled way, thanks to the engine management's ability to govern the engine speed, and apply the brakes when driving off-road if necessary. The vehicle's speed is maintained at a constant crawling pace.

<sup>1</sup> The values vary depending on the equipment and engine.  
<sup>2</sup> The incline on the left side is 49.7° and 50.8° on the right side.

Please note: these figures result from static calculations. The illustrations on these pages can only be regarded as a general guide. Please contact your local Volkswagen Commercial Vehicles Van Centre for details of the standard equipment and optional extras available.

Exterior	Interior & comfort	Safety systems	Off-road performance	Towing capacity & payload	Load platform	Equipment lines	Paint & upholstery	Alloy wheels, interior & comfort	Infotainment & assistance systems	Mobile online services	Technical information	Price list	Offers & finance	Service & warranties
----------	--------------------	----------------	----------------------	---------------------------	---------------	-----------------	--------------------	----------------------------------	-----------------------------------	------------------------	-----------------------	------------	------------------	----------------------



# More robust.

## Sturdy ladder frame design and an impressive towing capacity of up to 3.1 tonnes.

Exceptionally robust and with a premium finish, the Amarok is built to impress, even in heavy use. A warp-resistant ladder frame, which guarantees excellent body stability, and special leaf springs allow for a maximum payload of up to 1,146kg<sup>1</sup> and a trailer load of up to 3.1 tonnes.



The fixed **tow bar** with a ball head design is exceptionally durable and manufactured to tow a trailer load of up to 3.1 tonne braked.<sup>1</sup> Optional on all models.

The standard **3+2 leaf springs** offer high driving comfort and the highest UK payload.

<sup>1</sup> Amarok Trendline 3.0 litre V6 TDI 204PS 4MOTION.

Please contact your local Volkswagen Commercial Vehicles Van Centre for details of the standard equipment and optional extras available.





# Larger.

The widest load platform in its class, allowing Euro pallets to be loaded crosswise.

No other pick-up provides so much space between the wheel housings. The loading width of 1,222mm even enables Euro pallets to be loaded crosswise. The spacious 2.52m<sup>2</sup> cargo area features some impressive dimensions – such as the 508mm high side panels and the low loading sill height of 780mm.

Please contact your local Volkswagen Commercial Vehicles Van Centre for details of the standard equipment and optional extras available.





**01 Load platform.** The load platform in the Amarok is precisely 1,222mm across between the wheel housings – this is unique in its vehicle class and allows Euro pallets to be loaded across the platform. If necessary, the tailgate with a 200kg payload can be used as an extension of the load platform. When loaded to capacity, the cargo area offers space for 1.28m<sup>3</sup> of bulk goods on a surface of 2.52m<sup>2</sup>.

**TL HL BE AVBE**

**02 Load platform lighting.** Integrated lights illuminate the load platform, allowing you to load your cargo in the dark. In addition, it also features the integrated third brake light.

**TL HL**



**03 Load compartment protective coating.** The UV-resistant special coating in anthracite provides excellent protection against mechanical and chemical wear.

**TL HL BE AVBE**

**04 12V sockets** (not shown). Four 12V sockets are available, including one in the cargo area.

**HL BE AVBE**

■ Standard □ Optional at extra cost

TL | Trendline HL | Highline BE | Black Edition AVBE | Aventura Black Edition



# More individual.

A range of models with exclusive equipment.



Please contact your local Volkswagen Commercial Vehicles Van Centre for details of the standard equipment and optional extras available.

Exterior

Interior & comfort

Safety systems

Off-road performance

Towing capacity & payload

Load platform

Equipment lines



Paint & upholstery

Alloy wheels, interior & comfort

Infotainment & assistance systems

Mobile online services

Technical information

Price list

Offers & finance

Service & warranties



 Build your own

 Find a Van Centre

 Test drive

 Offers & Finance

 Conversions

 Comparator



# The Amarok Trendline.

For every purpose.

Starting from **£28,600†**

Please click here for more details.

17" 'Posadas' alloy wheels.

8-speed automatic with Permanent 4MOTION as standard.

Body-coloured front bumper.



Please contact your local Volkswagen Commercial Vehicles Van Centre for details of the standard equipment and optional extras available.

Volkswagen Commercial Vehicles may change RRP's at any time (this includes where there are government changes in regulation and/or legislation). There may be a delay to any RRP displaying correctly on our materials. Always obtain prices from your chosen authorised Van Centre.

† Basic RRP excluding VAT.

Exterior

Interior & comfort

Safety systems

Off-road performance

Towing capacity & payload

Load platform

Equipment lines



Paint & upholstery

Alloy wheels, interior & comfort

Infotainment & assistance systems

Mobile online services

Technical information

Price list

Offers & finance

Service & warranties



# The Amarok Trendline.

For every purpose.





# Standard equipment – Trendline.

Starting from **£28,600†** [Please click here for more details.](#)

## Audio and communications

- App-Connect
- Bluetooth® mobile phone preparation
- Composition Media DAB+ radio system with 6.33" touch-screen, voice enhancer, single MP3 compatible CD drive, SD card slot, USB interface, AUX-IN socket and six speakers
- Multifunction display plus
- Voice Control

## Interior

- Carpet floor covering in cab and rear passenger area
- Centre console with cover for storage compartment
- 'Climatronic' air conditioning
- Cruise control
- Cup holder in cab
- Decorative inserts in Deep Inox
- Driver and front passenger seats with height adjustment and armrests
- Dust and pollen filter
- Electric windows
- Heater air vents in cab and rear passenger area
- Kemisu fabric upholstery
- Leather multifunction steering wheel, gearknob, gaiter and handbrake handle
- Moulded headlining
- Servotronic speed-related variable steering
- Smoking pack with individually mountable ashtray
- Storage compartments under front seats
- Three rear headrests
- Twin sun visors with vanity mirrors and airbag label on passenger sun visor
- Windscreen wiper intermittent control, including manual dimming mirror
- 12V sockets x 3

## Exterior

- Black rear bumper with integrated step
- Body-coloured door mirrors, handles and front bumper with double chrome strip in upper grille
- Centre high-mounted brake light
- Door mirrors – electrically heated and adjustable
- Four load-lashing rings
- Front and rear fog lights
- Halogen twin headlights
- Headlight range adjustment
- Heated rear window
- Heat insulating glass
- Licence plate lighting
- Lockable tailgate
- Rear side windows and rear window in privacy glass
- Separate daytime running lights
- Trailer hitch preparation
- Wide wheel arch extensions

## Safety and Security

- Airbags – driver and front passenger (with passenger deactivation), side and front head protection
- Anti-lock Braking System (ABS)
- Automatic Post-Collision Braking System
- Electronic Stabilisation Programme (ESP)
- Hill Hold Assist
- Remote central locking with interior locking switch and two remote folding keys
- Seatbelt warning when not engaged
- Thatcham Category 1 approved alarm and immobiliser with back-up horn, tilt sensor, tow-away protection and single door unlocking
- Three-seat bench in rear row with ISOFIX mountings (x2 outer seats)
- 17" braking system to the front and 16" braking system at the rear (204PS models only)

## Wheels and tyres

- 17" 'Posadas' alloy wheels 8J x 17
- 245/65 R17 111T tyres
- Full size steel spare wheel
- Lockable wheel bolts
- Tool kit and jack



'Climatronic' air conditioning.



Composition Media DAB+ radio system.



17 inch 'Posadas' alloy wheel.

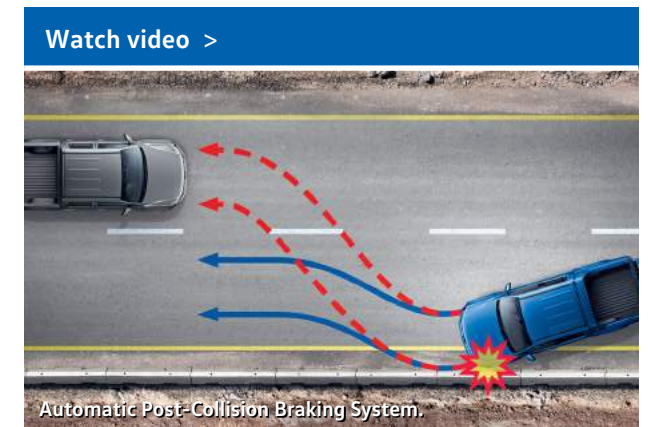

Automatic Post-Collision Braking System.

Please contact your local Volkswagen Commercial Vehicles Van Centre for details of the standard equipment and optional extras available.

Volkswagen Commercial Vehicles may change RRP's at any time (this includes where there are government changes in regulation and/or legislation). There may be a delay to any RRP displaying correctly on our materials. Always obtain prices from your chosen authorised Van Centre.

† Basic RRP excluding VAT.



Build your own

Find a Van Centre

Test drive

Offers & Finance

Conversions

Comparator



# The Amarok Highline.

For added refinement.

Starting from **£32,680†** [Please click here for more details.](#)



- 18" 'Manaus' alloy wheel.
- Bi-xenon headlights.
- Chrome-plated rear bumper.
- Side bars in stainless steel.
- Two double chrome trims on the radiator grille.

Please contact your local Volkswagen Commercial Vehicles Van Centre for details of the standard equipment and optional extras available.

Volkswagen Commercial Vehicles may change RRP's at any time (this includes where there are government changes in regulation and/or legislation). There may be a delay to any RRP displaying correctly on our materials. Always obtain prices from your chosen authorised Van Centre.

† Basic RRP excluding VAT.

Exterior	Interior & comfort	Safety systems	Off-road performance	Towing capacity & payload	Load platform	Equipment lines	Paint & upholstery	Alloy wheels, interior & comfort	Infotainment & assistance systems	Mobile online services	Technical information	Price list	Offers & finance	Service & warranties
----------	--------------------	----------------	----------------------	---------------------------	---------------	-----------------	--------------------	----------------------------------	-----------------------------------	------------------------	-----------------------	------------	------------------	----------------------



# The Amarok Highline.

For added refinement.



Front and rear parking sensors and rear-view camera.

Heated driver and front passenger seats with individual settings.

'Vienna' leather seat upholstery.<sup>1</sup>

<sup>1</sup> Centre seat panel and inner seat bolsters in 'Vienna' leather. The 'Vienna' upholstery is a leather seat upholstery with leatherette sections.

Please contact your local Volkswagen Commercial Vehicles Van Centre for details of the standard equipment and optional extras available.



# Additional equipment – Highline.

Starting from **£32,680†** [Please click here for more details.](#)

### Interior

- Decorative inserts in Light Silver
- Heated driver and front passenger seats with individual control
- Vienna leather upholstery<sup>1</sup>
- 12V sockets x 4, including x 1 in the cargo area

### Exterior

- Additional exterior dust seals
- Bi-xenon headlights with separate LED daytime running lights
- Chrome rear bumper with integrated step
- Darkened rear tail light lenses
- Front and rear parking sensors with rear-view camera
- Front grille with two chrome detailing strips and six vertical chrome ribs
- Heated washer nozzles
- LED licence plate lighting
- Side bars in stainless steel
- Washer fluid level indicator

### Wheels and tyres

- 18" 'Manaus' alloy wheels 7.5J x 18
- 255/60 R18 112T tyres



18 inch 'Manaus' alloy wheel.



Front and rear parking sensors.



Rear-view camera.



Bi-xenon headlights with separate LED daytime running lights.

<sup>1</sup> Centre seat panel and inner seat bolsters in 'Vienna' leather. The 'Vienna' upholstery is a leather seat upholstery with leatherette sections. Please contact your local Volkswagen Commercial Vehicles Van Centre for details of the standard equipment and optional extras available. Volkswagen Commercial Vehicles may change RRP's at any time (this includes where there are government changes in regulation and/or legislation). There may be a delay to any RRP displaying correctly on our materials. Always obtain prices from your chosen authorised Van Centre. † Basic RRP excluding VAT.

Exterior	Interior & comfort	Safety systems	Off-road performance	Towing capacity & payload	Load platform	Equipment lines	Paint & upholstery	Alloy wheels, interior & comfort	Infotainment & assistance systems	Mobile online services	Technical information	Price list	Offers & finance	Service & warranties
----------	--------------------	----------------	----------------------	---------------------------	---------------	-----------------	--------------------	----------------------------------	-----------------------------------	------------------------	-----------------------	------------	------------------	----------------------



# The Amarok Black Edition.

For confident road presence.

From **£34,835†**

Please click here for more details.



Please contact your local Volkswagen Commercial Vehicles Van Centre for details of the standard equipment and optional extras available.

Exclusive Matt paint offer. **Save £780 + VAT.** >

Volkswagen Commercial Vehicles may change RRP's at any time (this includes where there are government changes in regulation and/or legislation). There may be a delay to any RRP displaying correctly on our materials. Always obtain prices from your chosen authorised Van Centre.

† Basic RRP excluding VAT.



## Additional equipment – Black Edition.

From **£34,835†** [Please click here for more details.](#)

### Audio and communications

Discover Media navigation system with Guide & Inform, SD card x 2 and Off-road information display

### Interior

Black headlining  
Gloss black decorative insert on dashboard

### Exterior

Black fog light surrounds  
Black rear bumper  
Black side bars  
Black styling bar  
Black polish trim strip on grille  
Gloss black exterior mirror housings  
Lights & Vision pack

### Wheels and tyres

20" 'Talca' black alloy wheels 8J x 20  
255/50 R20 109H tyres



20 inch 'Talca' black alloy wheel.



Discover Media navigation system with Guide & Inform.



Black side bars.



Black fog light surrounds.

Please contact your local Volkswagen Commercial Vehicles Van Centre for details of the standard equipment and optional extras available.

Volkswagen Commercial Vehicles may change RRP's at any time (this includes where there are government changes in regulation and/or legislation). There may be a delay to any RRP displaying correctly on our materials. Always obtain prices from your chosen authorised Van Centre.

† Basic RRP excluding VAT.



# The Amarok Aventura Black Edition.

More dynamic, more premium.

From **£40,995†**

Please click here for more details.



20" 'Talca' black alloy wheels.

'Aventura' sports bar painted in body colour.

Black polish trim strip on grille.

Black rear bumper and side bars.

Front fog lights with cornering lights and black fog light surrounds.

Gloss black exterior mirror housings. Power folding, heated and power adjustable.

Lights & Vision pack.

Load compartment protective coating.

Underbody styling.

Exclusive Matt paint offer. **Save £780 + VAT.**

Please contact your local Volkswagen Commercial Vehicles Van Centre for details of the standard equipment and optional extras available.

Volkswagen Commercial Vehicles may change RRP's at any time (this includes where there are government changes in regulation and/or legislation). There may be a delay to any RRP displaying correctly on our materials. Always obtain prices from your chosen authorised Van Centre.

† Basic RRP excluding VAT.



## Additional equipment – Aventura Black Edition.

From **£40,995†**

Please click here for more details.

### Audio and communications

Discover Media navigation system with Guide & Inform, SD card x 2 and Off-road information display

### Interior

'Aventura' branded floor mats

Black headlining

'ErgoComfort' seats for driver and front passenger with 14-way adjustment (12 electrically, 2 manually)

Gloss black decorative insert on dashboard

Leather multifunction steering wheel with gear-shift paddles.

'Nappa' leather upholstery<sup>1</sup>

'Premium' colour multifunction display

### Exterior

Black fog light surrounds

Black polish trim strip on grille

Black rear bumper

Black side bars

Body coloured sports bar with stylish 'Aventura' emblem, attached on both sides

Front fog lights with cornering function

Gloss black exterior mirror housings

Lights & Vision pack

Load compartment protective coating

Underbody styling

### Safety and Security

Exterior mirrors power adjustable, heated and folding

### Wheels and tyres

20" 'Talca' black alloy wheels 8J x 20

255/50 R20 109H tyres



20 inch 'Talca' black alloy wheel.



Discover Media navigation system with Guide & Inform.



Body coloured sports bar with stylish 'Aventura' emblem, attached on both sides.



Underbody styling.

<sup>1</sup> Centre seat panel and inner seat bolsters in 'Nappa' leather. The 'Nappa' upholstery is a leather seat upholstery with leatherette sections. Please contact your local Volkswagen Commercial Vehicles Van Centre for details of the standard equipment and optional extras available. Volkswagen Commercial Vehicles may change RRP's at any time (this includes where there are government changes in regulation and/or legislation). There may be a delay to any RRP displaying correctly on our materials. Always obtain prices from your chosen authorised Van Centre.

† Basic RRP excluding VAT.



# Paint.



Candy White. Solid paint finish.  TL  HL  BE  AVBE



Tornado Red. Solid paint finish.  TL  HL  BE



Reflex Silver. Metallic paint finish.  TL  HL  BE  AVBE



Mojave Beige. Metallic paint finish.  TL  HL



Indium Grey. Metallic paint finish.  TL  HL  BE  AVBE



Chestnut Brown. Metallic paint finish.  TL  HL



Starlight Blue. Metallic paint finish.  TL  HL  BE  AVBE



Ravenna Blue. Metallic paint finish.  HL  BE  AVBE



Peacock Green. Metallic paint finish.  BE  AVBE



Deep Black. Pearl Effect paint finish.  TL  HL  BE  AVBE



Indium Grey. Matt paint finish.  HL  BE  AVBE



Ravenna Blue. Matt paint finish.  BE  AVBE

Standard  Optional at extra cost  
TL | Trendline HL | Highline BE | Black Edition AVBE | Aventura Black Edition

The illustrations on these pages can only be regarded as a general guide. Screen technology cannot render the colours with absolute accuracy. Please contact your local Volkswagen Commercial Vehicles Van Centre for details of the standard equipment and optional extras available.



# Upholstery.

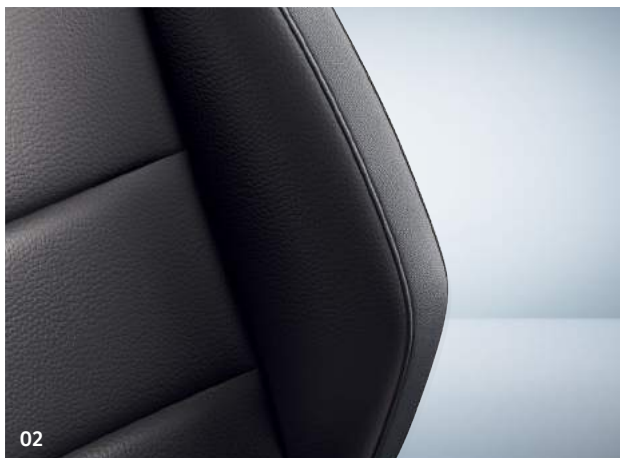
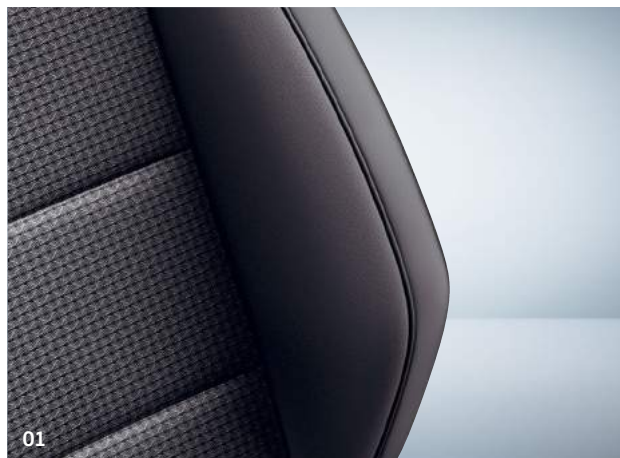

- 01 'Kemisu' cloth seat upholstery in Palladium Grey. **TL**
- 02 'Vienna'<sup>1</sup> leather seat upholstery in Palladium Grey and Titanium Black. Also available in Noisette Brown and Titanium Black. **HL BE**
- 03 'Nappa'<sup>2</sup> seat upholstery in Titanium Black. **AVBE**

1 Centre seat panel and inner seat bolsters in 'Vienna' leather. The 'Vienna' upholstery is a leather seat upholstery with leatherette sections.  
 2 Centre seat panel and inner seat bolsters in 'Nappa' leather. The 'Nappa' upholstery is a leather seat upholstery with leatherette sections.  
 The illustrations on these pages can only be regarded as a general guide. Screen technology cannot render the colours with absolute accuracy. Please contact your local Volkswagen Commercial Vehicles Van Centre for details of the standard equipment and optional extras available.

Standard  Optional at extra cost  
 TL | Trendline HL | Highline BE | Black Edition  
 AVBE | Aventura Black Edition



# Alloy wheels.



- 01 17" 'Posadas' alloy wheel. 8J x 17. With 245/65 R17 111T tyres. **TL**
- 02 18" 'Manaus' alloy wheel. 7.5J x 18. With 255/60 R18 112T tyres. **HL**
- 03 19" 'Cantera' alloy wheel. 8J x 19. With 255/55 R19 111T tyres. **HL**
- 04 20" 'Talca' alloy wheel. 8J x 20. With 255/50 R20 109H tyres. **HL**
- 05 20" 'Talca' black alloy wheel. 8J x 20. With 255/50 R20 109H tyres. **BE AVBE**

**Roll resistance-optimised tyres** (not shown). All Amarok models are equipped with fuel-conserving summer tyres as standard. These are manufactured from a special rubber compound which minimises deformation from driving. This can reduce fuel consumption depending on the speed and driving style.

Standard     Optional at extra cost  
**TL** | Trendline    **HL** | Highline    **BE** | Black Edition    **AVBE** | Aventura Black Edition

Please contact your local Volkswagen Commercial Vehicles Van Centre for details of the standard equipment and optional extras available.



## Interior and comfort.



**01 Leather-trimmed multifunction steering wheel with paddles.** It gives you excellent grip and is extremely user-friendly. The radio or navigation system and even your mobile phone can be controlled using the buttons without taking your hands off the wheel for added safety. Ergonomic paddles allow you to change gears for a sportier driving style.  
 TL  HL  BE  AVBE

**02 'Climatronic' air conditioning.** This system offers 2-zone temperature control for the driver and front passenger, manual air recirculation and an air quality sensor. Depending on the intensity of the sun's rays and the outside temperature, the air conditioning adds more or less cool air accordingly.  
 TL  HL  BE  AVBE

**Auxiliary water heater** (not shown). It enables you to pre-heat the engine while also heating up the interior quicker, or pre-heating it before you get in. The control unit is built into the roof console. Of course, you can also activate and deactivate the auxiliary water heater using the handy remote control.  
 HL  BE  AVBE

**03 'Premium' colour multifunction display.** Positioned directly in front of you on the dashboard for your convenience and safety, it comes with a high-resolution 3D colour display and animated menu guidance. Optional as part of the Navigation Tech package on Amarok Highline models.  
 HL  AVBE

**Multifunction display plus** (not shown). It displays up-to-date information, such as remaining range, outside temperature and average fuel consumption.  
 TL  HL  BE

Standard  Optional at extra cost

TL | Trendline HL | Highline BE | Black Edition AVBE | Aventura Black Edition

Please contact your local Volkswagen Commercial Vehicles Van Centre for details of the standard equipment and optional extras available.



# Infotainment.



01



02 | 03



04

**01 Voice control.** Operate the telephone, navigation and audio functions without taking your hands off the steering wheel. This function allows you to call up virtually all of the menus and notifications on the radio or navigation system display using voice commands.

TL HL BE AVBE

**Electronic voice enhancer** (not shown).<sup>1</sup> This function makes sure that passengers in the rear seats can hear the driver. The voice input is recorded through a hands-free microphone, amplified, and then transmitted over the loudspeaker in the rear.

TL HL BE AVBE

**02 Composition Media DAB+ radio system.** The Composition Media DAB+ radio system features a 6.33" touch-screen with proximity sensor, USB port, Bluetooth®, SD card slot, AUX-IN interface, MP3 and WMA compatible CD drive, 4 x 20 watt output with six speakers and a dual tuner with PhaseDiversity for optimum radio reception. 'App-Connect' guarantees the best possible connection.<sup>2</sup>

TL HL

**03 'App-Connect'**.<sup>2</sup> With this software, selected apps from your smartphone can be used while driving. 'App-Connect' supports 'MirrorLink™', Apple 'CarPlay' and 'Android Auto'.

TL HL BE AVBE

**04 Discover Media navigation system.** In addition to the Composition Media features, it also includes a second SD card slot and an SD card with map data for Europe. Volkswagen MapCare provides access to free updates for the installed maps. 'Guide & Inform' is an extension of the Discover Media navigation system and retrieves the latest information from the internet. If, for instance, a traffic jam is building, your chosen route will be changed in response to this. You can also choose to display the cheapest petrol station nearby, find car parks, get updates on the latest news and weather and much more. 'Guide & Inform' can be activated in just a few steps and used free-of-charge for three years.<sup>3</sup>

TL HL BE AVBE

■ Standard □ Optional at extra cost

TL | Trendline HL | Highline BE | Black Edition AVBE | Aventura Black Edition

1 The electronic voice amplification is included in the Composition Media radio system and Discover Media navigation system.

2 Compatible with 'MirrorLink™', Apple 'CarPlay' and 'Android Auto'. Please ensure that your end device is compatible with 'App-Connect'. 'App-Connect' apps are operated exclusively through your mobile phone.

Please note the conditions of your contract with regard to the data and Internet connection. Further information is available at [www.volkswagen-commercial-vehicles-carnet.com](http://www.volkswagen-commercial-vehicles-carnet.com)

3 Only available in conjunction with the Discover Media navigation system. From the fourth year, usage carries an extra charge. In order to establish an Internet connection, the customer will require their own mobile wireless router (e.g. a smartphone with Hotspot capability) or a suitable USB dongle that works with their own SIM card with an internet data tariff.

Please contact your local Volkswagen Commercial Vehicles Van Centre for details of the standard equipment and optional extras available.



## Driver assistance systems.

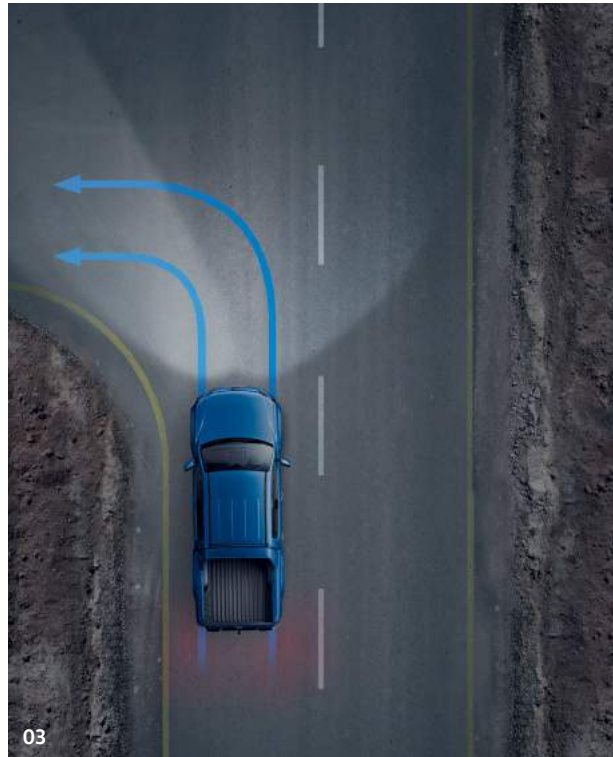

**01 Parking sensors.**<sup>1</sup> Emits audible warnings when obstacles are detected in front of or behind the vehicle when parking, and also provides a visual display of the vehicle's distance from the obstacles.

TL HL BE AVBE

**02 Rear-view reversing camera.** Simplifies parking by showing a limited view of the area behind the vehicle on the display of the radio or navigation system. Static guidelines facilitate the parking process.

HL BE AVBE

**Tyre pressure monitoring system** (not shown).<sup>1</sup> Measures the tyre pressure of each wheel on an ongoing basis and displays it on the multifunction display. The driver is warned if the pressure drops.

TL HL BE AVBE

**03 Fog lights with integrated static cornering lights.** Ensures optimal visibility in poor weather conditions. The headlight nearest to the corner illuminates the roadside when turning.

TL HL BE AVBE

**Lights and Vision pack** (not shown). The windscreen wipers are activated if it starts raining and the wiping interval is adapted to the intensity of the rainfall. Furthermore, the interior mirror is automatically tinted if the headlights in the vehicle behind are too bright. Also included in the package is an automatic headlight control for when light diminishes and the automatic 'coming home/leaving home' function.

TL HL BE AVBE

## Safety systems.

**01 Automatic Post-Collision Braking System.**<sup>1</sup> Triggers braking after a collision, with the aim of preventing secondary collisions. After a short delay, the vehicle begins a phased braking action down to 6mph, during which the driver can intervene at any time.

TL HL BE AVBE

**Electronic stabilisation programme** (not shown). Helps to prevent under- or over-steering via targeted braking of individual wheels.

TL HL BE AVBE

**02 Trailer stabilisation.**<sup>1</sup> Should the trailer start to deviate heavily, the system slows it down by means of controlled braking and reduced engine torque. This helps the trailer and increases driving safety.

TL HL BE AVBE

**Anti-theft warning system** (not shown). Triggers acoustic and visual warnings at signs of unauthorised entry. As well as interior monitoring, the system includes an electronic immobiliser, a safelock with deactivation and a tow-away warning.

TL HL BE AVBE

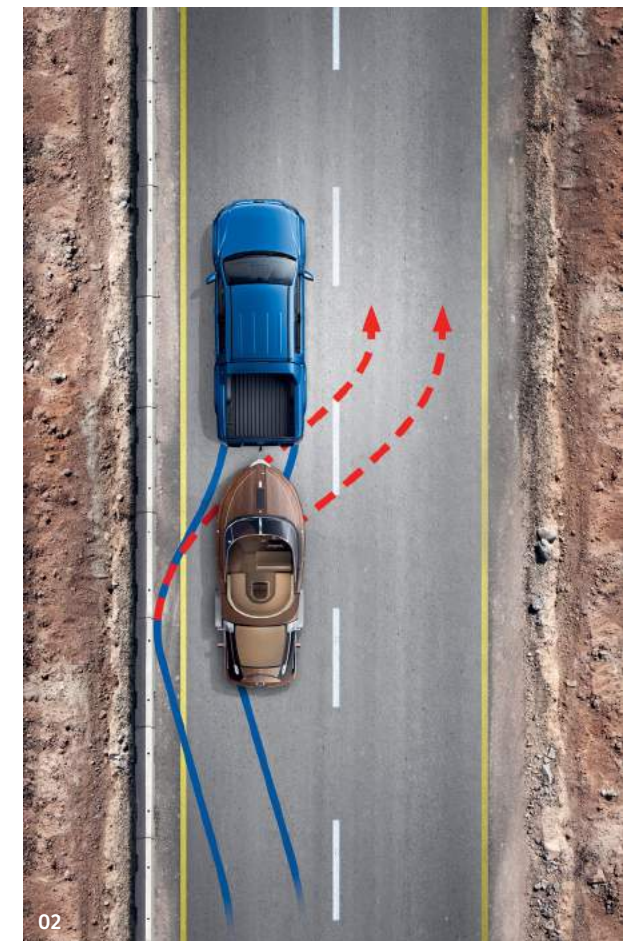
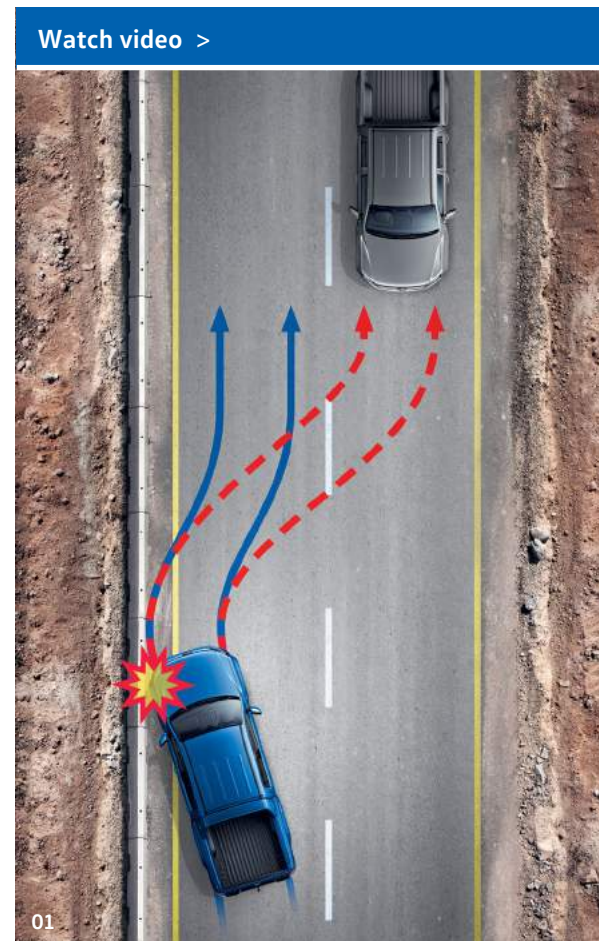

Standard Optional at extra cost

TL | Trendline HL | Highline BE | Black Edition AVBE | Aventura Black Edition

<sup>1</sup> Within the system thresholds.

Please contact your local Volkswagen Commercial Vehicles Van Centre for details of the standard equipment and optional extras available.



# Perfectly connected.

The future of mobility is now the present – and available upon request in your Volkswagen commercial vehicle. The mobile online services enable you to enhance the Amarok, transforming it into an Internet-based information centre. 'App-Connect' enables you to conveniently use and control content on your smartphone even while driving.

TL HL BE AVBE

Using 'Guide & Inform', you expand the Discover Media navigation system to include numerous additional on-board information services.

TL HL BE AVBE



Standard Optional at extra cost  
TL | Trendline HL | Highline  
BE | Black Edition AVBE | Aventura Black Edition



## 'App-Connect'.<sup>1</sup>

Experience infotainment on the road and integrate your smartphone or tablet into your vehicle with 'App-Connect' via a USB port. 'App-Connect' mirrors compatible apps from your smartphone on the radio or navigation system's touchscreen display. Using 'Android Auto', Apple 'CarPlay' or 'MirrorLink™', you can comfortably control certain apps via the touchscreen display while driving.



You can use the following Volkswagen apps via 'MirrorLink™' while driving: 'Drive & Track', 'Shared Audio', 'Call & Remind' and 'My Guide'. More information is available at [www.volkswagen-vans.co.uk/about-us/technology/car-net](http://www.volkswagen-vans.co.uk/about-us/technology/car-net)

## 'Guide & Inform'.<sup>2</sup>

If your vehicle is fitted with an optional navigation system, you can activate the online-based 'Guide & Inform' services. 'Guide & Inform' is available free of charge for the first three years after registration. You can utilise two types of services: services that support you directly in the vehicle and services you configure from home - either via the customer portal or via the Car-Net app. To use 'Guide & Inform' in the vehicle, simply generate a hotspot with your smartphone.

### Well informed in your vehicle.

'Guide & Inform' keeps the driver up to date: with online-based traffic information, fuel station prices, available parking spaces nearby and a Google POI search in the navigation system.



Online Traffic Information



Fuel Info



Parking Info<sup>3</sup>



Online Traffic Information



News



Weather

### Well organised from home.

Using the customer portal, you can set-up online routes, destinations and POIs and then import them into the navigation system. The Car-Net app also synchronises calendar entries and driving destinations.



Online Route Import



Online Destination Import



My POIs



Vehicle Health Report



Time Manager

### Registration - A few simple steps:

- 1 Create your personal account at [www.volkswagen-car-net.com/portal/en\\_GB/web/gb/login](http://www.volkswagen-car-net.com/portal/en_GB/web/gb/login)
- 2 Enter your vehicle identification number (VIN).
- 3 You receive an 8 digit registration code.
- 4 Use your smartphone to create a mobile hotspot or use the Volkswagen CarStick.
- 5 Enter the registration code into the navigation system.

<sup>1</sup> 'App-Connect' is available in conjunction with the Composition Media radio system or the Discover Media systems. 'App-Connect' comprises MirrorLink™, CarPlay™ and Android Auto™. The availability of these technologies may vary depending on the country in question. Please note that 'App-Connect' is not currently supported by every mobile telephone on the market. Volkswagen is working closely with major smartphone producers to promote broader compatibility for 'App-Connect'. <sup>2</sup> The use of 'Guide & Inform' mobile online services is only possible with the optional Discover Media system. You will also require a mobile device (e.g. smartphone) that is capable of acting as a mobile wireless hotspot, which must be paid for separately. The Guide & Inform services are only available with an existing mobile network contract or one to be concluded separately for this purpose between you and your mobile phone network provider, and only within the respective mobile phone network coverage. Depending on your mobile phone tariff, receiving data from the Internet may incur additional charges, particularly if you are using the phone abroad (e.g. roaming charges). Due to the amount of data needed when using Car-Net services, we strongly recommend signing up to a flat rate data plan with your mobile phone provider. Use of Car-Net is governed in a separate agreement concluded online with Volkswagen AG. After receiving possession of the vehicle, the customer has 90 days in which to register the vehicle at [www.volkswagen-car-net.com/portal/en\\_GB/web/gb/login](http://www.volkswagen-car-net.com/portal/en_GB/web/gb/login). Availability of Car-Net Services may vary depending on the country in question. These services are available for the duration of the contract term agreed, and may be subject to changes in terms of content during the contract period. More detailed information on Car-Net is available at [www.volkswagen-vans.co.uk/about-us/technology/car-net](http://www.volkswagen-vans.co.uk/about-us/technology/car-net) and from your Volkswagen Partner; contact your mobile network provider for information on your mobile network tariff conditions. <sup>3</sup> Available for car parks with suitable technical infrastructure. There is currently no information available regarding entry heights for the car parks in question. Please contact your local Volkswagen Commercial Vehicles Van Centre for details of the standard equipment and optional extras available.



## Engine & gearbox data.

Engine specifications.	3.0 V6 TDI 204PS	3.0 V6 TDI 258PS
Engine type	V6 cylinder diesel engine	V6 cylinder diesel engine
Mixture preparation/injection method	Common-rail/exhaust-gas turbocharger	Common-rail/exhaust-gas turbocharger
EU exhaust emission standard	EURO 6D Temp	EURO 6D Temp
Number of cylinders	6	6
Cubic capacity	2,970cc	2,970cc
Output, PS at rpm	204 at 3,000-4,500	258 at 3,250-4,000
Torque, max. Nm at rpm	500 at 1,250-2,750	580 at 1,400-3,000
Fuel tank capacity	80 litre	80 litre
AdBlue® tank capacity	13 litre	13 litre
Diesel Particulate Filter [DPF]	Yes	Yes
8-speed automatic gearbox	Yes	Yes
Permanent 4MOTION all-wheel drive	Yes	Yes
Alternator	120A-180A	120A-180A
Battery	92Ah (520A)	92Ah (520A)



## Fuel consumption, performance and emissions.

Engine/transmission	CO <sub>2</sub> emissions, g/km <sup>1</sup>		Combined fuel consumption mpg <sup>1</sup>		Combined fuel consumption (ltr/100km) <sup>1</sup>		Acceleration, seconds 0 - 62mph	Top speed, mph, (where law permits)
	Max.	Min.	Max.	Min.	Max.	Min.		
<b>Trendline.</b>								
3.0 V6 TDI 204PS Permanent 4MOTION 8-speed automatic	232	231	25.9	28.2	10.9	10.0	9.1	118
<b>Highline.</b>								
3.0 V6 TDI 204PS Permanent 4MOTION 8-speed automatic	232	231	25.9	28.2	10.9	10.0	9.1	118
3.0 V6 TDI 258PS Permanent 4MOTION 8-speed automatic	232	231	25.9	28.2	10.9	10.0	7.4	129
<b>Black Edition.</b>								
3.0 V6 TDI 204PS Permanent 4MOTION 8-speed automatic	232	231	25.9	28.2	10.9	10.0	9.1	118
3.0 V6 TDI 258PS Permanent 4MOTION 8-speed automatic	232	231	25.9	28.2	10.9	10.0	7.4	129
<b>Aventura Black Edition.</b>								
3.0 V6 TDI 258PS Permanent 4MOTION 8-speed automatic	232	231	25.9	27.7	10.9	10.2	7.4	129

<sup>1</sup> These vehicles are WLTP (Worldwide Harmonised Light-Duty Vehicles Test Procedure) type approved vehicles. More information is available at [www.volkswagen-vans.co.uk/about-us/wltp](http://www.volkswagen-vans.co.uk/about-us/wltp). However, to facilitate comparison between different models from different manufacturers and to accommodate the full transition to this new testing regime, we have displayed NEDC figures. These NEDC figures have been derived from WLTP testing, and may not be equivalent to NEDC figures from NEDC testing, so comparisons may be unreliable. Fuel consumption and efficiency figures are provided for comparative purposes only and may not reflect 'real world' driving results. Choice of wheels and other options may affect fuel consumption and emissions data.



# Weights.

Engine/transmission	Gross vehicle weight <sup>1</sup> , kg	Axle load limit, front/rear, kg	Trailer weight braked 12%/unbraked, kg	Gross train weight, kg	Unladen weight <sup>2</sup> , kg	Payload <sup>3</sup> , kg
<b>Trendline.</b>						
3.0 V6 TDI 204PS Permanent 4MOTION 8-speed automatic	3,290	1,445 / 1,930	3,100 / 750	6,000	2,143	1,147
<b>Highline.</b>						
3.0 V6 TDI 204PS Permanent 4MOTION 8-speed automatic	3,290	1,445 / 1,930	3,100 / 750	6,000	2,180	1,110
3.0 V6 TDI 258PS Permanent 4MOTION 8-speed automatic	3,290	1,445 / 1,930	3,100 / 750	6,000	2,180	1,110
<b>Black Edition.</b>						
3.0 V6 TDI 204PS Permanent 4MOTION 8-speed automatic	3,290	1,445 / 1,930	3,100 / 750	6,000	2,220	1,070
3.0 V6 TDI 258PS Permanent 4MOTION 8-speed automatic	3,290	1,445 / 1,930	3,100 / 750	6,000	2,220	1,070
<b>Aventura Black Edition.</b>						
3.0 V6 TDI 258PS Permanent 4MOTION 8-speed automatic	3,290	1,445 / 1,930	3,100 / 750	6,000	2,260	1,030

1 These vehicles are WLTP (Worldwide Harmonised Light-Duty Vehicles Test Procedure) type approved vehicles. More information is available at [www.volkswagen-vans.co.uk/about-us/wltp](http://www.volkswagen-vans.co.uk/about-us/wltp). However, to facilitate comparison between different models from different manufacturers and to accommodate the full transition to this new testing regime, we have displayed NEDC figures. These NEDC figures have been derived from WLTP testing, and may not be equivalent to NEDC figures from NEDC testing, so comparisons may be unreliable. Fuel consumption and efficiency figures are provided for comparative purposes only and may not reflect 'real world' driving results. Choice of wheels and other options may affect fuel consumption and emissions data.

2 Unladen weight includes approximately 90% fuel load.

3 Payload = gross vehicle weight minus unladen weight. Quoted weights are for vehicles with standard specification. Unladen weight and payload may be influenced by trimline, factory options and Van Centre fitted accessories. Roof load limit: 100kg. Trailer nose weight: 140kg.

# Dimensions.

Wheelbase		3,097
Length		5,254
Width		1,954
Load area	length	1,555
	width	1,620
	width between wheel arches	1,222
	load area	2.52m <sup>2</sup>
Rear tailgate	width	1,364
	height	508
Ground clearance		192
Wading depth		500
Turning circle (wall to wall)		12.95m

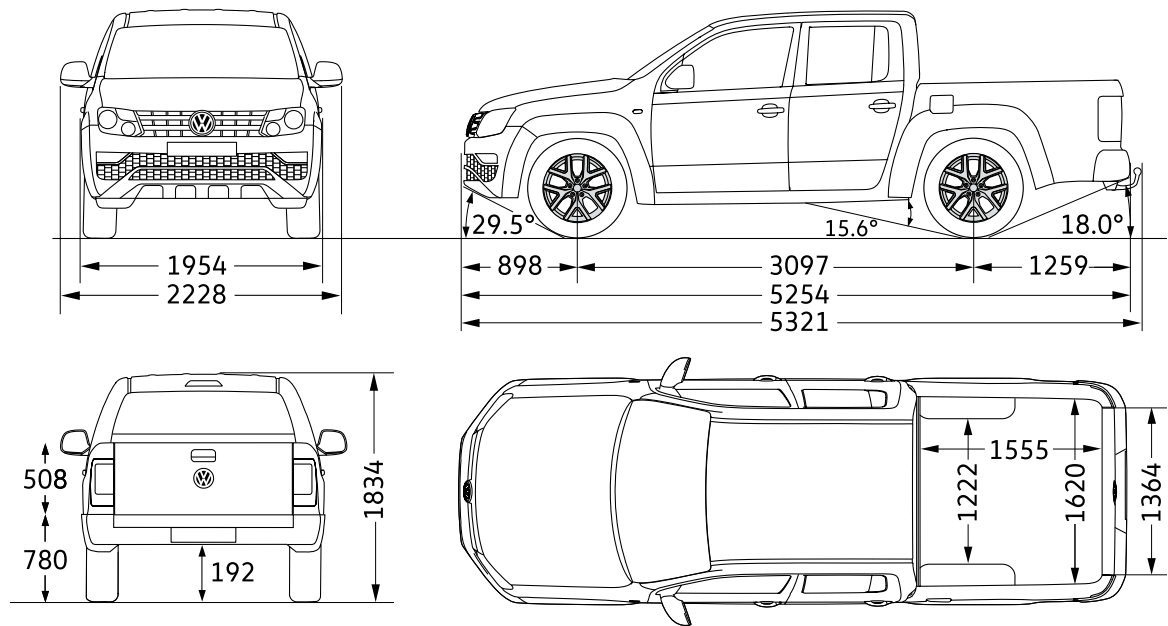

Please note: Vehicle drawings are not to scale. All dimensions in millimetres (mm), unless otherwise stated. The height measurements listed may vary by ± 50mm depending on model and equipment fitted.



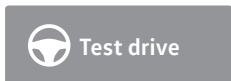
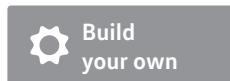

## Model prices.

Trimline	Engine/transmission	Basic exc. VAT	Total inc. VAT	Total RRP inc. OTR* exc. VAT	Total RRP inc. OTR* inc. VAT
Trendline	3.0 V6 TDI 204PS Permanent 4MOTION 8-speed automatic	£28,600.00	£34,320.00	£29,555.00	£35,403.00
Highline	3.0 V6 TDI 204PS Permanent 4MOTION 8-speed automatic	£32,680.00	£39,216.00	£33,635.00	£40,299.00
	3.0 V6 TDI 258PS Permanent 4MOTION 8-speed automatic	£36,310.00	£43,572.00	£37,265.00	£44,655.00
Black Edition	3.0 V6 TDI 204PS Permanent 4MOTION 8-speed automatic	£34,835.00	£41,802.00	£35,790.00	£42,885.00
	3.0 V6 TDI 258PS Permanent 4MOTION 8-speed automatic	£38,465.00	£46,158.00	£39,420.00	£47,241.00
Aventura Black Edition	3.0 V6 TDI 258PS Permanent 4MOTION 8-speed automatic	£40,995.00	£49,194.00	£41,950.00	£50,277.00

### \*Manufacturer's on the road (OTR) package.

Delivery to Van Centre	£620.00
Number plates	£20.00
VAT	£128.00
First registration fee	£55.00
Vehicle excise duty (VED) 1st year	£260.00
<b>Basic OTR price (exc. VAT)</b>	<b>£955.00</b>
<b>Total OTR price (inc. VAT)</b>	<b>£1,083.00</b>

**Volkswagen Commercial Vehicles may change RRP's at any time (this includes where there are government changes in regulation and/or legislation). There may be a delay to any RRP displaying correctly on our materials. Always obtain prices from your chosen authorised Van Centre.**



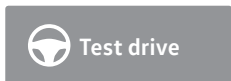
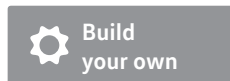

## Options.

Paint.	PR Code.	Trendline.		Highline.		Black Edition.		Aventura Blk Ed.	
		Basic exc. VAT	Total RRP inc. VAT	Basic exc. VAT	Total RRP inc. VAT	Basic exc. VAT	Total RRP inc. VAT	Basic exc. VAT	Total RRP inc. VAT
<b>Solid.</b> Candy White (B4B4), Tornado Red (G2G2) <sup>1</sup> .	As shown	○	○	○	○	○	○	○	○
<b>Metallic.</b> Peacock Green (8U8U).	As shown	-	-	-	-	£575.00	£690.00	£575.00	£690.00
<b>Metallic.</b> Chestnut Brown (H4H4) <sup>1,2</sup> , Indium Grey (X3X3), Mojave Beige (1B1B) <sup>1,2</sup> , Reflex Silver (8E8E), Ravenna Blue (5Z5Z) <sup>3</sup> or Starlight Blue (3S3S).	As shown	£575.00	£690.00	£575.00	£690.00	£575.00	£690.00	£575.00	£690.00
<b>Pearl effect.</b> Deep Black (2T2T).	As shown	£575.00	£690.00	£575.00	£690.00	£575.00	£690.00	£575.00	£690.00
<b>Matt.</b> Indium Grey (9709). Includes grained black door handles and wing mirror housings with lower chrome plating.	As shown	-	-	£3,265.00	£3,918.00	£2,485.00	£2,982.00	£2,485.00	£2,982.00
Ravenna Blue (9547). Includes grained black door handles and wing mirror housings with lower chrome plating.	As shown	-	-	-	-	£2,485.00	£2,982.00	£2,485.00	£2,982.00

## Upholstery.

<b>Seat trim covers in Palladium Grey/Titanium Black Kemisu fabric.</b> Dashboard in Titanium Black, floor covering in Black.	N0L	●	●	-	-	-	-	-	-
<b>Seat trim covers in Palladium Grey/Titanium Black Vienna leather.<sup>4</sup></b> Dashboard in Titanium Black, floor covering in Black.	N1D	-	-	●	●	●	●	-	-
<b>Seat trim covers in Noisette Brown/Titanium Black Vienna leather.<sup>4</sup></b> Dashboard in Titanium Black, floor covering in Black.	N1D	-	-	●	●	●	●	-	-
<b>Seat trim covers in Titanium Black Nappa leather.<sup>4</sup></b> Dashboard in Titanium Black, floor covering in Black.	N4L	-	-	-	-	-	-	●	●

## Seating.

<b>ErgoComfort driver and front passenger seats with 14-way adjustment.</b> 12 electrically, 2 manually.	ZSB	-	-	£1,100.00	£1,320.00	£1,100.00	£1,320.00	●	●
<b>Lumbar support (manual) for driver and front passenger seats.</b>	7P4	£140.00	£168.00	£140.00	£168.00	£140.00	£168.00	-	-

● Standard - Not available ○ At no extra cost Where additional equipment is required by chosen options, additional equipment will be charged at the prices shown.

1 Tornado Red solid paint, Chestnut Brown and Mojave Beige metallic paints are not available on Aventura.

2 Chestnut Brown and Mojave Beige metallic paints are not available on Black Edition.

3 Ravenna Blue metallic paint is not available on Trendline.

4 Seat material in contact with driver and passengers is leather, all other areas are leatherette.

**Volkswagen Commercial Vehicles may change RRP's at any time (this includes where there are government changes in regulation and/or legislation). There may be a delay to any RRP displaying correctly on our materials. Always obtain prices from your chosen authorised Van Centre.**



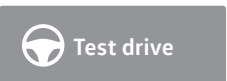
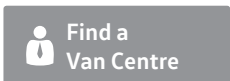
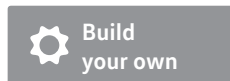

# Options (continued).

Wheels and tyres.	PR Code.	Trendline.		Highline.		Black Edition.		Aventura Blk Ed.		
		Basic exc. VAT	Total RRP inc. VAT	Basic exc. VAT	Total RRP inc. VAT	Basic exc. VAT	Total RRP inc. VAT	Basic exc. VAT	Total RRP inc. VAT	
17" 'Posadas' alloy wheels. 8J x 17.	CA6	●	●	-	-	-	-	-	-	
18" 'Manaus' alloy wheels. 7.5J x 18.	CV1	-	-	●	●	-	-	-	-	
19" 'Cantera' alloy wheels. 8J x 19. With steel space saver spare wheel.	ZRQ	-	-	£495.00	£594.00	-	-	-	-	
20" 'Talca' alloy wheels. 8J x 20.	ZRA	-	-	£1,295.00	£1,554.00	-	-	-	-	
20" 'Talca' black alloy wheels. 8J x 20.	48P	-	-	-	-	●	●	●	●	
<b>Audio and communications.</b>										
Composition Media DAB+ radio system with 6.33" touch-screen. Includes six speakers and App-Connect.	ZI4	●	●	●	●	-	-	-	-	
Discover Media navigation system. Includes Guide & Inform, SD card x 2, European map data and Off-road information display.	RI7	£600.00	£720.00	£600.00	£720.00	●	●	●	●	
<b>Comfort and convenience.</b>										
Carpet floor covering in cab – in lieu of rubber.	5AD	●	●	●	●	●	●	●	●	
Rubber floor covering in cab.	ZB2	£110.00	£132.00	£110.00	£132.00	£110.00	£132.00	£110.00	£132.00	
Storage compartment under front seats.	QN4	●	●	●	●	●	●	●	●	
<b>Driver assistance.</b>										
Leather multi-function steering wheel.	2ZH	●	●	●	●	●	●	-	-	
Leather multi-function steering wheel with gear-shift paddles – automatic only.	ZM1	£130.00	£156.00	£130.00	£156.00	£130.00	£156.00	●	●	
Parking sensors, front and rear.	7X2	£445.00	£534.00	●	●	●	●	●	●	

● Standard - Not available ○ At no extra cost Where additional equipment is required by chosen options, additional equipment will be charged at the prices shown.

Volkswagen Commercial Vehicles may change RRP's at any time (this includes where there are government changes in regulation and/or legislation). There may be a delay to any RRP displaying correctly on our materials. Always obtain prices from your chosen authorised Van Centre.



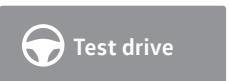
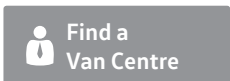
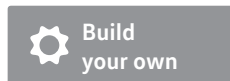

# Options (continued).

Packages.	PR Code.	Trendline.		Highline.		Black Edition.		Aventura Blk Ed.	
		Basic exc. VAT	Total RRP inc. VAT	Basic exc. VAT	Total RRP inc. VAT	Basic exc. VAT	Total RRP inc. VAT	Basic exc. VAT	Total RRP inc. VAT
Centre high-mounted LED brake light.	8R4	●	●	●	●	-	-	●	●
Centre high-mounted LED brake light with cargo area lighting.	8R1	£25.00	£30.00	£25.00	£30.00	-	-	-	-
Chrome style pack. <sup>1</sup> Chrome-effect stainless steel styling bar and side bars without step.	YFE	£1,645.00	£1,974.00	£1,120.00	£1,344.00	-	-	-	-
Lights & Vision pack. Includes automatic headlights with separate daytime running lights, Coming Home feature, windscreen wiper intermittent control with rain sensor.	ZL2	£200.00	£240.00	£200.00	£240.00	●	●	●	●
Load compartment protective coating.	YMB	£720.00	£864.00	£720.00	£864.00	£720.00	£864.00	●	●
Side bars.	YJB	-	-	●	●	●	●	●	●
Navigation Tech pack. Includes Discover Media navigation system, tyre pressure warning light, 'Premium' colour multi-function display, upgraded anti-theft alarm system (to include all door unlocking) and power folding wing mirrors.	ZBB	-	-	£1,000.00	£1,200.00	-	-	-	-
Without model and engine designation badges.	0NM	○	○	○	○	○	○	○	○
Without model designation badge, with engine designation badge.	0NA	○	○	○	○	○	○	○	○

## Body and chassis.

Additional underbody protection to front.	1SB	£25.00	£30.00	£25.00	£30.00	£25.00	£30.00	-	-
Differential lock.	1Y4	£270.00	£324.00	£270.00	£324.00	£270.00	£324.00	£270.00	£324.00
Lockable easy-opening tailgate.	3RQ	●	●	●	●	●	●	●	●
Remove styling bar.	W42	-	-	-	-	-£500.00	-£600.00	-	-
Towbar, fixed ball. <sup>2</sup> With 13-pin socket and electrics.	1D1	£320.00	£384.00	£320.00	£384.00	£320.00	£384.00	£320.00	£384.00
Towbar, preparation.	1D7	●	●	●	●	●	●	●	●
Without mudflaps.	6N0	●	●	●	●	-	-	-	-
Wing mirrors. Heated and power adjustable.	6XD	●	●	●	●	●	●	-	-
Wing mirrors. Heated, power adjustable and power folding. Highline still includes chrome housing.	6XE	-	-	£140.00	£168.00	£140.00	£168.00	●	●

● Standard - Not available ○ At no extra cost Where additional equipment is required by chosen options, additional equipment will be charged at the prices shown.

1 Not in conjunction with any hardtop or load compartment cover e.g. roll and lock. 2 Towbar. An adapter is available from Van Centres to allow connection to twin 7-pin sockets.

**Volkswagen Commercial Vehicles may change RRP's at any time (this includes where there are government changes in regulation and/or legislation). There may be a delay to any RRP displaying correctly on our materials. Always obtain prices from your chosen authorised Van Centre.**



## Options (continued).

Cargo area.	PR Code.	Trendline.		Highline.		Black Edition.		Aventura Blk Ed.		
		Basic exc. VAT	Total RRP inc. VAT	Basic exc. VAT	Total RRP inc. VAT	Basic exc. VAT	Total RRP inc. VAT	Basic exc. VAT	Total RRP inc. VAT	
Load-lashing rings.	6B1	●	●	●	●	●	●	●	●	
Load-lashing rings. Six folding load-lashing rings.	6B7	£40.00	£48.00	£40.00	£48.00	£40.00	£48.00	£40.00	£48.00	
<b>Electrical.</b>										
Body builder interface for external device.	IS1	£65.00	£78.00	£65.00	£78.00	£65.00	£78.00	£65.00	£78.00	
Tachograph preparation.	9ND	£255.00	£306.00	£255.00	£306.00	£255.00	£306.00	£255.00	£306.00	
<b>Heating and ventilation.</b>										
Climatronic air-conditioning system.	KH4	●	●	●	●	●	●	●	●	
Water heater with programmable parking heater function and radio remote control.	7VL	-	-	£1,220.00	£1,464.00	£1,220.00	£1,464.00	£1,220.00	£1,464.00	
<b>Safety and security.</b>										
First aid kit with warning triangle and hi-vis vest.	1T9	£35.00	£42.00	£35.00	£42.00	£35.00	£42.00	£35.00	£42.00	
Front fog lights.	8WB	●	●	●	●	●	●	-	-	
Front fog lights with cornering lights.	8WH	£85.00	£102.00	£85.00	£102.00	£85.00	£102.00	●	●	
Tyre pressure warning light.	7K3	£170.00	£204.00	£170.00	£204.00	£170.00	£204.00	£170.00	£204.00	

● Standard - Not available ○ At no extra cost Where additional equipment is required by chosen options, additional equipment will be charged at the prices shown.

Volkswagen Commercial Vehicles may change RRP's at any time (this includes where there are government changes in regulation and/or legislation). There may be a delay to any RRP displaying correctly on our materials. Always obtain prices from your chosen authorised Van Centre.



# Finance made simple. As dedicated to finance as we are to your new Amarok.

Learn more about our range of finance products to find a finance package that suits your budget.

Alternatively, 'Click on' the Offers & Finance button above to find out more about our latest offers to help your business thrive.

**Cost of your vehicle**

**Deposit**  
As little as one monthly repayment

**Monthly repayments**  
Spread across 18 to 49 months

**Optional final payment**  
You have three choices at the end of your agreement



**Own Hire**

**Cost of your vehicle**

**Deposit**  
As little as one monthly repayment

**Repayments**  
Spread across 12 to 60 months



**Own**

**Cost of your vehicle**

**Deposit**  
As little as one monthly repayment

**Rental repayments**  
Spread across 12 to 48 months

**Final 'balloon' repayment**



**Own**

**Solutions Personal Contract Plan**  
Not sure if you want to own or hire? Make the decision later. Pay monthly payments for the length of your agreement. At the end you can decide to keep (once all payments have been made), upgrade or return the vehicle.

**Hire Purchase**  
Make all the regular monthly payments. At the end the vehicles is yours.

**Lease Purchase**  
Make lower monthly payments by deferring an amount until the end. Once paid the vehicle is yours.

**Cost of your vehicle**

**Initial rental**  
As little as one rental repayment

**Rental repayments**  
Spread across 12 to 60 months



**Hire**

**Cost of your vehicle**

**Initial rental**  
As little as one rental repayment in advance

**Rental repayments**  
Spread across 12 to 60 months



**Hire**

**Cost of your vehicle**

**Initial rental**  
As little as one rental repayment in advance

**Rental repayments**  
Spread across 12 to 48 months

**Final 'balloon' repayment**  
You have two options at the end of your agreement



**Hire**

**Contract Hire**  
Pay fixed monthly rentals to hire the vehicle. Look after it so at the end you can return it hassle free.

**Finance Lease (full pay out)**  
Pay monthly rentals to hire the vehicle. At the end you have two options. Sell the vehicle and receive a percentage of the sale proceeds. Or retain the use of your vehicle by paying a reduced annual rental.

**Finance Lease (balloon repayment)**  
Pay monthly rentals to hire the vehicle. At the end you have two options. Sell the vehicle to settle the outstanding amount and receive any excess sale proceeds. Or pay the 'balloon' payment and retain the use of your vehicle by paying a reduced annual rental.

Finance subject to status. Available to 18s and over in the UK only. Terms and Conditions apply. Volkswagen Commercial Vehicle Financial Services.



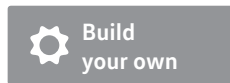

# Service & warranties.

### Finance and insurance.<sup>1</sup>

When it comes to paying for your van, we've got options including Contract Hire and Finance Lease, or Hire Purchase. We can also offer you competitive insurance.

### A choice of packages.<sup>2</sup>

Whether you prefer to lease your vehicles, with none of the concerns of ownership and the freedom to change models easily, or purchase outright to own the vehicle, we're here to help you consider your options.

You can go flexible, by choosing a payment plan that suits your finances, with options to reduce your monthly costs and your repayment period. Or choose a fixed monthly price that allows you to budget confidently for the longer term.

You can even include your road tax and servicing costs to arrive at one simple, all-inclusive payment. For more information, pick up a finance brochure, or ask at your Van Centre.

### Volkswagen insurance.

Volkswagen Commercial Vehicles Insurance<sup>3</sup> provides cost-effective and comprehensive motor insurance<sup>3</sup>, as well as gap insurance<sup>4</sup>, which helps replace your vehicle and protect you from any financial shortfall if it's written off.

### Insurance benefits include:

- Complimentary 5-day drive away insurance cover.
- All repairs performed by approved repairers.
- Volkswagen Genuine Parts<sup>®</sup> used on all repairs.
- Courtesy vehicle provided during repair following an accident (subject to availability).
- Cover for breakage and damage to glass.
- In-vehicle personal belongings cover (up to £250).
- Vehicle recovery.
- 90-day European Union cover.

For more information about our motor insurance call: **0345 877 6355** (lines open 9am-6pm Monday-Friday) or visit: [insurewithwcv.co.uk](http://insurewithwcv.co.uk)

### Servicing and support.

We're here to keep you moving, with our range of three award-winning<sup>5</sup> servicing and maintenance options, as well as free Roadside Assistance. Some exclusions apply. For more detail, please visit [www.volkswagen-vans.co.uk/aftersales](http://www.volkswagen-vans.co.uk/aftersales).

### Pay monthly.

This option is available for vehicles that are less than 12 months old and have covered less than 10,000 miles. It makes budgeting easier by splitting the cost of servicing into fixed monthly payments – whether you want Service only; Service and Maintenance; or Service, Maintenance and Tyres.

### Pay upfront.<sup>6</sup>

If you can pay for more than one service upfront, we'll help by reducing your costs. Buy two upfront and you'll receive one interim and one full service at a discounted rate. Buy four and you'll receive two interim and two full services, with your next MOT also included.

### Pay on demand.

If you're looking for freedom and flexibility with your servicing, it's good to know we're ready when you are. So with our third option, you can choose to pay for your services as and when you need them, with our National Service Pricing. Ask your Van Centre for an up-to-date pricing guide.

### Roadside Assistance.

We understand the need to keep you mobile. That's why all new vans come with three-year, unlimited mileage roadside cover. Should the unexpected happen, one call gets you straight through to a team trained to help you through any breakdown or accident. Supporting you every day will be a team of vehicle technicians, fully-trained by Volkswagen and carrying the latest diagnostic equipment, specialist tools and parts.

### Assistance benefits include:

- Assistance at home, by the roadside or place of work.
- Recovery to your preferred location.
- Onward travel, for you and your cargo.
- Cover 24 hours a day, 365 days a year.
- Free cover for three years (on new vehicles).
- Unlimited mileage.
- European cover.
- Option to extend cover beyond three years.

### Warranties.

You can count on us long after you purchase your vehicle, thanks to its comprehensive three-year, 100,000 mile warranty. While your vehicle is under warranty, we'll fix any defect in manufacture or workmanship free of charge, even if you purchase and service the vehicle at different Van Centres. Some exclusions apply and the vehicle must be cared for using the guidance in your owner's manual. For more detail, please visit [www.volkswagen-vans.co.uk/aftersales](http://www.volkswagen-vans.co.uk/aftersales).

### Extended warranty.

You can also extend your warranty beyond the three-year, 100,000 mile period, choosing either Comprehensive or Major Component cover, as a one-off or monthly payment. For more detail of cover levels, along with terms and conditions, please visit [volkswagencvwarranty.co.uk](http://volkswagencvwarranty.co.uk) where you'll also be able to obtain a quote and purchase an extended warranty.

### Paint and body warranty.

Your vehicle's exterior paintwork is covered against manufacturing defects for a period of three years, while its body sections and panels are covered against rusting through from the inside for 12 years. Some exclusions apply and the vehicle must be cared for using the guidance in your owner's manual.

### The Van Centre network.

Our **dedicated Van Centre network** is at the core of everything we do and is always there to help. As a separate brand within the Volkswagen Group, it makes sense to make use of your nearest Van Centre – it's full of experts who understand your vehicle better than anyone else and can help you to get the most out of it.

Over **70 Van Centres** and **24 Authorised Repairers**, means you're only around 45 minutes on average from our door.

1 Volkswagen Commercial Vehicles Insurance and Volkswagen Commercial Vehicle Financial Services are trading names of Volkswagen Financial Services (UK) Limited, Brunswick Court, Yeomans Drive, Blakelands, Milton Keynes MK14 5LR, which is authorised and regulated by the Financial Conduct Authority (FCA). Registered in England and Wales No. 2835230. Volkswagen Financial Services (UK) Limited financial services register number is 311988.

2 An offer of finance depends on certain conditions. Finance subject to status. Available to 18s and over. Terms and conditions apply. Volkswagen Commercial Vehicle Financial Services.

3 Volkswagen Commercial Vehicle Insurance is arranged by U K Insurance Business Solutions Limited and is underwritten by U K Insurance Limited. U K Insurance Business Solutions Limited is authorised and regulated by the Financial Conduct Authority and U K Insurance Limited is authorised by the Prudential Regulation Authority and regulated by the Financial Conduct Authority and the Prudential Regulation Authority. U K Insurance Business Solutions Limited. Registered office: Churchill Court, Westmoreland Road, Bromley, Kent BR1 1DP. Registered in England and Wales No. 05196274. Calls may be recorded.

4 Volkswagen Commercial Vehicle Insurance gap insurance is underwritten by MAPFRE Asistencia Compañía Internacional de Seguros y Reaseguros Sociedad Anonima authorised by Dirección General de Seguros y Fondos de Pensiones and subject to limited regulation by the Financial Conduct Authority and Prudential Regulation Authority, number 203041. Details about the extent of their regulation by the Financial Conduct Authority and Prudential Regulation Authority are available on request. MAPFRE Asistencia Compañía Internacional de Seguros y Reaseguros Sociedad Anonima is incorporated and registered in the Kingdom of Spain and registered as a foreign company in the United Kingdom with company number FC021974, acting through its UK branch with branch number BR008042 and whose principal office is at Alpha House, 5th Floor, 24A Lime Street, London EC3M 7HS. Volkswagen Commercial Vehicle Insurance gap insurance is administered by Abraxas Insurance Administration Services Limited, who is authorised and regulated by the Financial Conduct Authority with FCA number 308702 and who acts on behalf of the Insurer. Abraxas Insurance Administration Services Limited is registered in England and Wales with company number: 02928787 and whose registered office is at One Glass Wharf, Bristol BS2 0SX. Volkswagen Financial Services (UK) Limited is authorised and regulated by the Financial Conduct Authority (FCA). Authorisation details can be checked on the Financial Services register at [www.fca.org.uk/firms/systems-reporting/register](http://www.fca.org.uk/firms/systems-reporting/register) or call 0800 111 6768. Volkswagen Financial Services (UK) Limited is not part of the same corporate group as MAPFRE Asistencia Compañía Internacional de Seguros y Reaseguros Sociedad Anonima and Abraxas Insurance Administration Service Limited.

5 Business Vans Awards 2014 and 2015: Best Service Package for Van Owners.

6 Class 4 MOT only. This option is available to all new and used vehicles up to four years old or with less than 80,000 miles on the clock. Services must be used consecutively prior to vehicle reaching eight years old.

Exterior	Interior & comfort	Safety systems	Off-road performance	Towing capacity & payload	Load platform	Equipment lines	Paint & upholstery	Alloy wheels, interior & comfort	Infotainment & assistance systems	Mobile online services	Technical information	Price list	Offers & finance	Service & warranties
----------	--------------------	----------------	----------------------	---------------------------	---------------	-----------------	--------------------	----------------------------------	-----------------------------------	------------------------	-----------------------	------------	------------------	----------------------



 Build  
your own

 Find a  
Van Centre

 Test drive

 Offers &  
Finance

 Conversions

 Comparator



# The Amarok

This brochure supersedes all previous publications.

Issue: 1 November 2019

[www.volkswagen-vans.co.uk](http://www.volkswagen-vans.co.uk)

Please note: Screen technology does not allow exact reproduction of the paint and upholstery colours. Some of the vehicles shown are European specification and may be fitted with optional equipment or accessories that are available at extra cost, or do not reflect current specification. All data and specifications are in accordance with information available at the time of publication and are subject to change without notice. Vehicles not currently in UK stock and customer order vehicles may take a number of weeks for delivery. Certain combinations of vehicle specifications and factory-fitted options are not compatible and therefore all orders received are subject to confirmation. Models, factory fitted-options and paint and upholstery options are subject to availability. Please check details and availability with an authorised Volkswagen Van Centre at the time of ordering.