



View offers > Coupé  
> Cabriolet



Book a test drive > Coupé  
> Cabriolet  
> AMG



> Find a Retailer



> View the Range Guide

# E-Class

Coupé and Cabriolet



Effective from December 2019 Production.

Mercedes-Benz





View offers [> Coupé](#)  
[> Cabriolet](#)



Book a test drive [> Coupé](#)  
[> Cabriolet](#)  
[> AMG](#)



[> Find a Retailer](#)



[> View the Range Guide](#)

# Contents

<b>7</b> Standard equipment overview	<b>24</b> Mercedes-AMG driver training	<b>42</b> ServiceCare
<b>8</b> 4MATIC all-wheel drive	<b>25</b> Model prices	<b>43</b> Genuine Accessories
<b>9</b> Mercedes me	<b>27</b> Pricing summary for model lines	<b>46</b> Technical data
<b>11</b> Model lines	<b>29</b> Colours and materials	<b>56</b> Road Fund Licence
<b>17</b> Mercedes-AMG model lines	<b>35</b> Wheels	<b>57</b> Services and insurance
<b>23</b> Driving Assistance package	<b>37</b> Standard equipment	<b>58</b> Mercedes-Benz Finance



View offers

- > Coupé
- > Cabriolet



Book a  
test drive

- > Coupé
- > Cabriolet
- > AMG



> Find a Retailer



> View the Range Guide







View offers > Coupé  
> Cabriolet



Book a test drive > Coupé  
> Cabriolet  
> AMG



> Find a Retailer



> View the Range Guide



Some of the model features, optional extras and colours shown may not be available, or may only be available in a different specification.





View offers > Coupé  
> Cabriolet



Book a test drive > Coupé  
> Cabriolet  
> AMG



> Find a Retailer



> View the Range Guide



Some of the model features, optional extras and colours shown may not be available, or may only be available in a different specification.





View offers > Coupé  
> Cabriolet



Book a test drive > Coupé  
> Cabriolet  
> AMG



> Find a Retailer



> View the Range Guide



Some of the model features, optional extras and colours shown may not be available, or may only be available in a different specification.





View offers > Coupé  
> Cabriolet



Book a test drive > Coupé  
> Cabriolet  
> AMG



> Find a Retailer



> View the Range Guide

# Standard equipment overview



MULTIBEAM LED headlamps



Mirror package and Parking package



Ambient lighting – 64 colours



Blind Spot Assist



Widescreen cockpit display



COMAND Online



View offers > Coupé  
> Cabriolet



Book a test drive > Coupé  
> Cabriolet  
> AMG



> Find a Retailer



> View the Range Guide

## 4MATIC all-wheel drive

The 4MATIC all-wheel drive provides more dynamics, comfort and safety on normal roads. Whether you are on road or off road, 4MATIC guarantees optimal traction and excellent handling on any surface, at all times, thanks to the perfect interaction of the individual wheels.

Available with E 400 d, E 450 or Mercedes-AMG 53 engines.

### Key benefits:

---

Precise handling and control

---

Greater traction and driving stability on slippery surfaces and even on the toughest terrain

---

Enhanced safety

---

Optimal traction reduces friction, improving efficiency

---

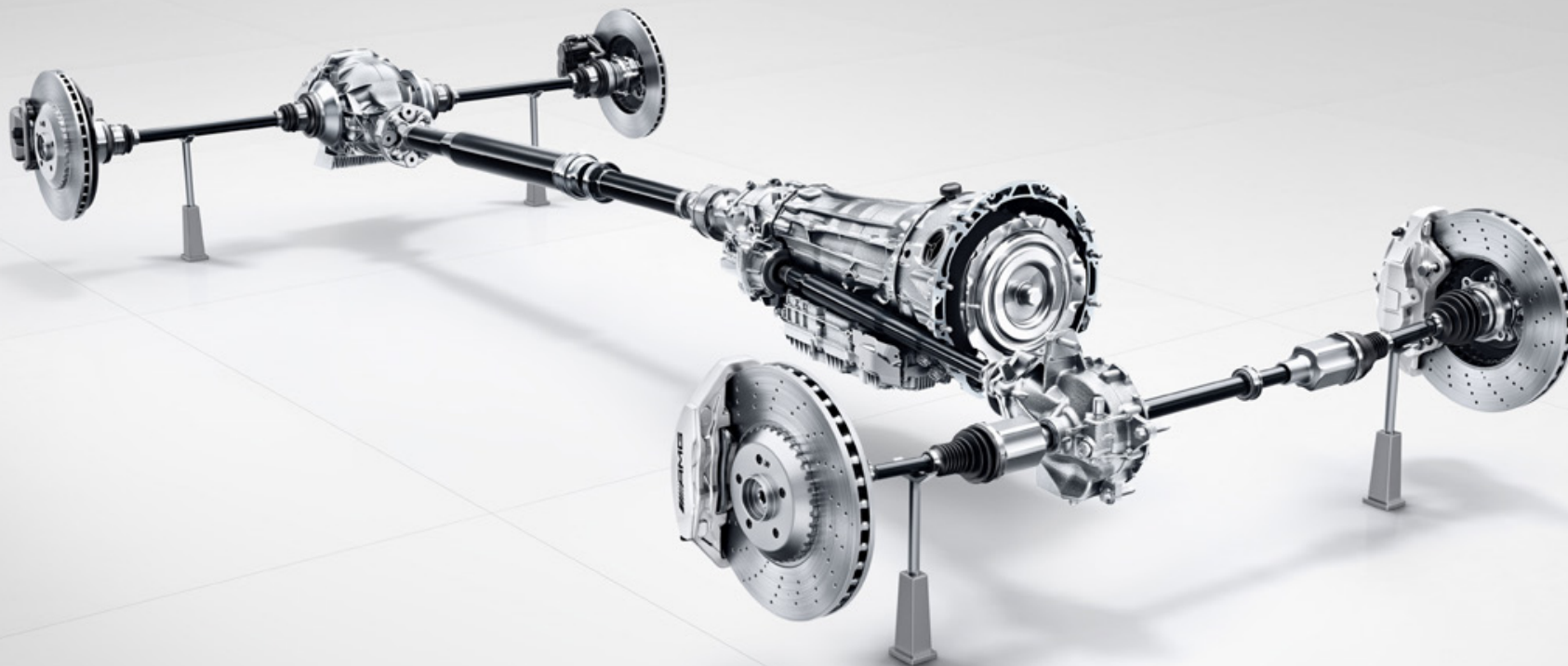



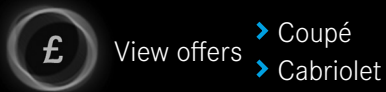

View offers > Coupé  
> Cabriolet

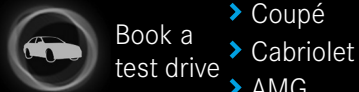

Book a test drive > Coupé  
> Cabriolet  
> AMG

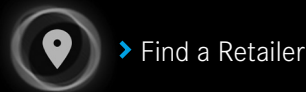

> Find a Retailer

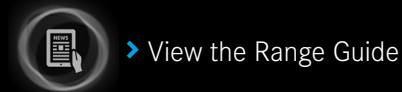

> View the Range Guide

# Mercedes me connect.

## Stay connected, any time, anywhere.

Mercedes me is a range of innovative online services designed to enhance your Mercedes-Benz experience. Accessible via mobile, tablet or PC, Mercedes me lets you enjoy the highest standards of care and support, in a way that integrates seamlessly with your busy lifestyle.



### Navigation Services (01U)

Visit the Mercedes me connect store or app for pricing.



#### Live Traffic Information<sup>1</sup>

Your navigation system receives traffic data in real time, enabling it to optimise the dynamic route guidance, minimising drive time and offering more precise estimation of arrival times.



#### Available parking spaces

Locates parking spaces for you in multi-storey car parks and on the street. Saving you time and hassle.



#### connect Store

In the Mercedes me connect Store you can purchase many digital services designed to make your everyday life easier and provide useful information relating to your networked vehicle.



#### TIDAL

Love music? Get a 12-month TIDAL HiFi subscription free with Mercedes me connect (worth £240) and unlock access to 58 million songs.



#### Local Search

This feature provides support in the local search for restaurants or hotels and much more.



#### Send2Car

Make your journey easier: set your destination using the Mercedes me app and send it directly to your car's navigation system.

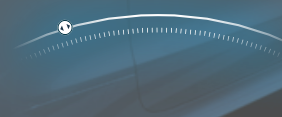

#### Internet Radio

Listen to podcasts and radio stations from anywhere in the world.



#### Private Car sharing

Car sharing gives you the opportunity to share your vehicle in a straightforward and safe way with third parties who you authorise.

For more information speak to your local Retailer or visit the Mercedes me connect store at [shop.mercedes-benz.com/en-gb/connect](http://shop.mercedes-benz.com/en-gb/connect)

<sup>1</sup>Free of charge for first three years. Extension possible, visit the Mercedes me connect store for details on pricing

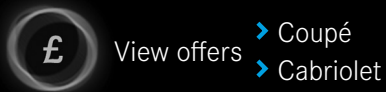

View offers > Coupé  
> Cabriolet

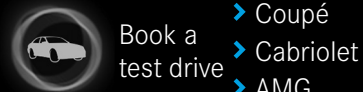

Book a test drive > Coupé  
> Cabriolet  
> AMG

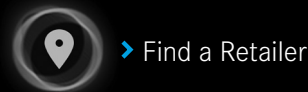

> Find a Retailer

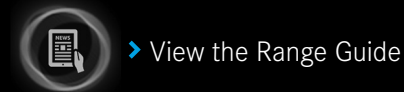

> View the Range Guide

# Mercedes me connect.

## Stay connected, any time, anywhere.

Mercedes me is a range of innovative online services designed to enhance your Mercedes-Benz experience. Accessible via mobile, tablet or PC, Mercedes me lets you enjoy the highest standards of care and support, in a way that integrates seamlessly with your busy lifestyle.



### Vehicle Set-up (08U)

Visit the Mercedes me connect store or app for pricing.



#### Remote Vehicle Status

Check safety information, such as coolant level and brake pad condition, so you can be sure your car is safe and ready to drive.



#### Personalisation

Store your preferences, such as your favourite radio stations and apps, to create your personal driver profile.



#### Parked Vehicle Locator

Forgot where you parked your car? No problem: you can locate and track your car, with the Parked Vehicle Locator.



#### Vehicle Tracker

Track the location of your car anywhere in the world.



#### Pre-Entry Climate Control

Programming of charging settings and Pre-Entry Climate Control for plug-in vehicles.



#### Remote Door Locking/Unlocking

Lock and unlock your car remotely, wherever you are in the world.



#### ECO Display

Monitor your driving style with ECO Display. It summarises your driving style from the start of the journey to its completion to help you achieve the most economical way to drive.



#### Geo-fencing

Set up a geographical boundary and receive alerts whenever your car enters or leaves this area.

For more information speak to your local Retailer or visit the Mercedes me connect store at [shop.mercedes-benz.com/en-gb/connect](http://shop.mercedes-benz.com/en-gb/connect)





View offers > Coupé  
> Cabriolet



Book a test drive > Coupé  
> Cabriolet  
> AMG



> Find a Retailer



> View the Range Guide

## E-Class AMG Line Premium





View offers > Coupé  
> Cabriolet



Book a test drive > Coupé  
> Cabriolet  
> AMG



> Find a Retailer



> View the Range Guide



Model lines | AMG Line Premium

12

3-spoke multifunction AMG steering wheel in black nappa leather with flattened bottom section, chrome inserts and touch-control buttons



Wireless charging



Black ARTICO man-made leather/DINAMICA microfibre





View offers > Coupé  
> Cabriolet



Book a test drive > Coupé  
> Cabriolet  
> AMG



> Find a Retailer



> View the Range Guide

The E-Class AMG Line Premium takes its cues from our AMG performance experts, focused on sporty design as well as athletic handling. AMG bodystyling and perforated brake discs with ‘Mercedes-Benz’ lettering all complement the look. Innovative technologies include MULTIBEAM LED headlamps and the Parking package with Active Parking Assist and a 360° camera to help you manoeuvring and parking.

The interior is equipped with black ARTICO man-made leather/DINAMICA microfibre and black open-pore ash wood trim on dashboard and centre console. Heated front seats with partial electric adjustment and four-way lumbar support come as standard. This is further complemented by KEYLESS-GO starting function and a 3-spoke multifunction AMG steering wheel in black nappa leather with flattened bottom section.

#### Engine, Transmission and Suspension

DYNAMIC SELECT with a choice of driving modes (ECO, Comfort, Sport, Sport+ and Individual)

#### Exterior

Parking package including 360° camera – Active Parking Assist makes it easier to find and select a parking space as well as to enter or leave parallel and end-on parking spaces or garages. The 360° camera transfers a realistic image to the multimedia system’s display, thus providing assistance when parking and manoeuvring

Mirror package – electrically folding mirrors and automatically-dimming exterior driver’s mirror and rear-view mirror

19" AMG alloy wheels – 5-spoke design, painted titanium grey

AMG bodystyling – front and rear apron, side sill panels

Brake discs – perforated, with ‘Mercedes-Benz’ lettering

Headlamps – MULTIBEAM LED headlamps

Privacy glass for rear side windows and rear windscreen (Coupé only)

#### Interior

Memory package – driver’s seat, front passenger seat, steering column and exterior mirrors – electrically adjustable with memory; includes electro-pneumatic four-way lumbar support and seat cushion depth adjustment (6 cm)

AMG Line floor mats

Black roof lining

Brushed stainless steel AMG sports pedals with rubber studs

Dashboard upper section in black ARTICO man-made leather with topstitching

Front seats – belt feeder automatically positions seat belts

Front seats – heated with partial electric adjustment and electro-pneumatic four-way lumbar support

KEYLESS-GO starting function

Steering wheel – 3-spoke multifunction AMG steering wheel in black nappa leather with flattened bottom section, chrome inserts and touch-control buttons

#### Communications, Safety and Assistance Systems

COMAND Online system<sup>1</sup> with Media Interface and touchpad

DAB digital radio tuner

Wireless charging<sup>2</sup>

#### Trim and Upholstery

Black open-pore ash wood trim



ARTICO man-made leather/DINAMICA microfibre – black



Coupé OTR from **£44,260<sup>3</sup>**  
Cabriolet OTR from **£48,755<sup>3</sup>**

<sup>1</sup>COMAND Online functionality and Wi-Fi connectivity is dependent on a compatible cellular data connection. Please check with your local Mercedes-Benz Retailer on network compatibility <sup>2</sup>Compatible mobile phone required

<sup>3</sup>The recommended on-the-road price includes the Road Fund Licence applicable to the standard model plus delivery charge (£715.00 incl. VAT), new vehicle registration fee (£55.00) and number plates (£25.00 incl. VAT). VAT is calculated at the standard rate of 20%



View offers > Coupé  
> Cabriolet



Book a test drive > Coupé  
> Cabriolet  
> AMG



> Find a Retailer



> View the Range Guide

# E-Class AMG Line Night Edition Premium Plus







View offers

- > Coupé
- > Cabriolet



Book a test drive

- > Coupé
- > Cabriolet
- > AMG



Find a Retailer



View the Range Guide



Model lines | AMG Line Night Edition Premium Plus

15

Burmester® surround sound system and KEYLESS-GO Comfort package



Panoramic electric glass sunroof (Coupé only)



Black ARTICO man-made leather/DINAMICA microfibre



View offers > Coupé  
> Cabriolet



Book a test drive > Coupé  
> Cabriolet  
> AMG



> Find a Retailer



> View the Range Guide

The E-Class AMG Line Night Edition Premium Plus emphasises its athletic exterior with high-gloss black painted 20" AMG multi-spoke alloy wheels and a diamond radiator grille with integral Mercedes-Benz star with a single louvre in high-gloss black. Further details in high-gloss black, such as the exterior mirror housings, the front apron or the rear bumper add to the

impressive look of this model line. Inside, you'll find ARTICO man-made leather/DINAMICA microfibre upholstery matched with black open-pore ash wood trim. This is further complemented by KEYLESS-GO Comfort package including hands-free access, and the Burmester® surround sound system with 13 speakers and a 9-channel amplifier.

*In addition/replacement to AMG Line Premium:*

#### Exterior

20" AMG alloy wheels – multi-spoke design, painted high-gloss black

Diamond radiator grille with integral Mercedes-Benz star and a single louvre in high-gloss black

Exterior mirror housings in high-gloss black

Front apron in high-gloss black

Panoramic electric glass sunroof – the electric panoramic sliding sunroof covers two thirds of the roof area (Coupé only)

Rear bumper in high-gloss black with chrome trim

Waistline trim strip in high-gloss black (Coupé only)

#### Interior

KEYLESS-GO Comfort package – including hands-free access, automatic powered boot closing (Coupé only), keyless entry and keyless start

#### Communications, Safety and Assistance Systems

Burmester® surround sound system – 13 speakers and a 9-channel amplifier with total output of 590 watts

#### Trim and Upholstery

Black open-pore ash wood trim

ARTICO man-made leather/DINAMICA microfibre – black

Coupé OTR from **£46,905<sup>1</sup>**  
 Upgrade price from AMG Line Premium **£2,645**  
 Cabriolet OTR from **£50,455<sup>1</sup>**  
 Upgrade price from AMG Line Premium **£1,700**

<sup>1</sup>The recommended on-the-road price includes the Road Fund Licence applicable to the standard model plus delivery charge (£715.00 incl. VAT), new vehicle registration fee (£55.00) and number plates (£25.00 incl. VAT). VAT is calculated at the standard rate of 20%





View offers > Coupé  
> Cabriolet



Book a test drive > Coupé  
> Cabriolet  
> AMG



> Find a Retailer



> View the Range Guide

# Mercedes-AMG E 53 4MATIC+ Premium





View offers > Coupé  
> Cabriolet



Book a test drive > Coupé  
> Cabriolet  
> AMG



> Find a Retailer



> View the Range Guide



Model lines | Mercedes-AMG E53 4MATIC+ Premium

18

AMG start-up logo in central screen



MULTIBEAM LED Intelligent Light System



Black nappa leather with red contrast stitching





View offers > Coupé  
> Cabriolet



Book a test drive > Coupé  
> Cabriolet  
> AMG



> Find a Retailer



> View the Range Guide

The Mercedes-AMG E-Class E 53 4MATIC+ Premium combines powerful performance with high efficiency. Fitted with a 6-cylinder in-line engine, it generates 435 hp (320 kW) and 520 Nm maximum torque. These sporty credentials are matched by the iconic diamond grille, AMG bodystyling, and 'BITURBO 4MATIC+' lettering on the front wings. 20" AMG 5-spoke alloy

wheels add to the powerful posture. Inside, you'll find nappa leather upholstery with red stitching and red seat belts. A host of innovative features include a MULTIBEAM LED Intelligent Light System, a Memory package that records seat settings and a Parking package with a 360° camera.

#### Engine, Transmission and Suspension

AMG DYNAMIC SELECT with a choice of driving modes

AMG RIDE CONTROL sports suspension based on AIR BODY CONTROL air suspension

#### Exterior

Parking package with 360° camera

19" AMG alloy wheels – 5-twin-spoke, high-gloss black with high-shine finish

AMG bodystyling – front apron with distinctive air intakes, AMG side sill panels and AMG rear apron with diffuser look

'AMG' lettering on front brake calipers

AMG performance exhaust system

'BITURBO 4MATIC+' lettering on front wings

Diamond grille with integrated star, chrome pins and 'AMG' lettering

MULTIBEAM LED Intelligent Light System

#### Interior

Memory package – driver's seat, front passenger seat, steering column and exterior mirrors – electrically adjustable with memory; includes electro-pneumatic four-way lumbar support and seat cushion depth adjustment (6 cm)

Seat Comfort package

AMG start-up logo in central screen

Floor mats – with black leather edging, red piping and AMG logo

Front door sill panels with 'AMG' lettering

Red seat belts

Seats – rear, split folding 40:20:40

#### Communications, Safety and Assistance Systems

COMAND Online system<sup>1</sup> with Media Interface and touchpad

Wireless charging<sup>2</sup>

#### Trim and Upholstery

Black open-pore ash wood



Nappa leather – black with red contrast topstitching



Coupé OTR from **£65,260**<sup>3</sup>  
Cabriolet OTR from **£69,755**<sup>3</sup>

<sup>1</sup>COMAND Online functionality and Wi-Fi connectivity is dependent on a compatible cellular data connection. Please check with your local Mercedes-Benz Retailer on network compatibility <sup>2</sup>Compatible mobile phone required

<sup>3</sup>The recommended on-the-road price includes the Road Fund Licence applicable to the standard model plus delivery charge (£715.00 incl. VAT), new vehicle registration fee (£55.00) and number plates (£25.00 incl. VAT). VAT is calculated at the standard rate of 20%



View offers > Coupé  
> Cabriolet



Book a test drive > Coupé  
> Cabriolet  
> AMG



> Find a Retailer



> View the Range Guide

## Mercedes-AMG E 53 4MATIC+ Premium Plus







View offers > Coupé  
> Cabriolet



Book a test drive > Coupé  
> Cabriolet  
> AMG



> Find a Retailer



> View the Range Guide



Model lines | Mercedes-AMG E53 4MATIC+ Premium Plus

21

Burmester® surround sound system – 13 speakers and a 9-channel amplifier with total output of 590 watts

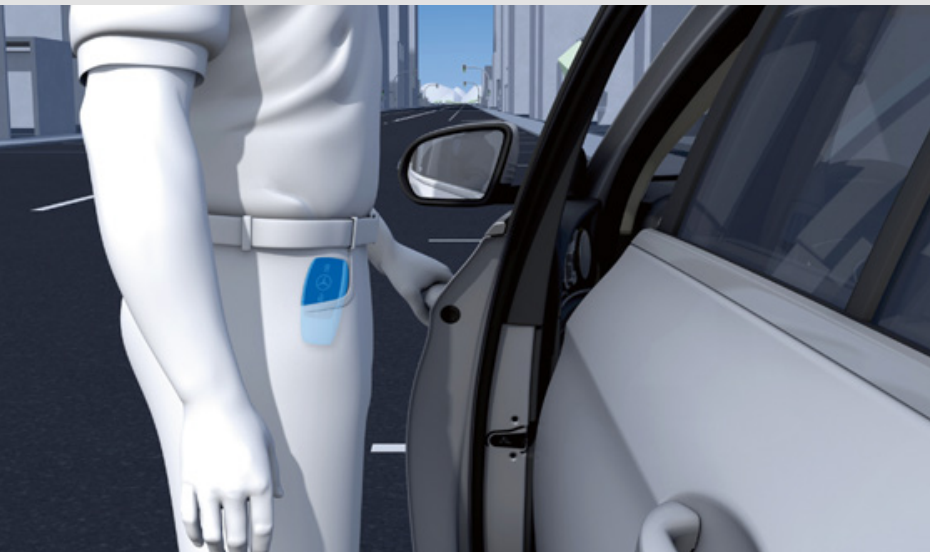

KEYLESS-GO Comfort package – including hands-free access, automatic powered boot closing and keyless entry



Black nappa leather with red contrast stitching

The Mercedes-AMG E-Class E 53 4MATIC+ Premium Plus enhances your E-Class with further design features and equipment that add to your comfort. Equipped with 20" AMG 5-twin-spoke alloy wheels painted black with a high-sheen finish, perforated brake discs with 'Mercedes-Benz' lettering and AMG bodystyling allround, this model truly is a showstopper.

Inside, you'll find black nappa leather upholstery with red topstitching matched with black open-pore ash wood trim. And while the KEYLESS-GO Comfort package allows for hands-free access, the Burmester® surround sound system ensures an outstanding listening experience.

*In addition/replacement to Mercedes-AMG E 53 4MATIC+ Premium:*

#### Exterior

KEYLESS-GO Comfort package – including hands-free access, automatic powered boot closing and keyless entry

20" AMG alloy wheels – 5-twin-spoke, painted in black with high-sheen finish

AMG bodystyling – front and rear apron, side sill panels

Brake discs – perforated, with 'AMG' lettering

Panoramic glass sunroof – the electric panoramic sliding sunroof covers two thirds of the roof area (Coupé only)

Privacy glass for rear side windows and rear windscreen (Coupé only)

#### Communications, Safety and Assistance Systems

Burmester® surround sound system – 13 speakers and a 9-channel amplifier with total output of 590 watts

#### Trim and Upholstery

Black open-pore ash wood



Nappa leather – black with red contrast topstitching



Nappa leather – black/saddle brown



Nappa leather – black/classic red



Coupé OTR from **£68,750<sup>1</sup>**

Upgrade price from Mercedes-AMG E 53 4MATIC Premium **£3,490**

Cabriolet OTR from **£72,245<sup>1</sup>**

Upgrade price from Mercedes-AMG E 53 4MATIC Premium **£2,490**

<sup>1</sup>The recommended on-the-road price includes the Road Fund Licence applicable to the standard model plus delivery charge (£715.00 incl. VAT), new vehicle registration fee (£55.00) and number plates (£25.00 incl. VAT). VAT is calculated at the standard rate of 20%





View offers > Coupé  
> Cabriolet



Book a test drive > Coupé  
> Cabriolet  
> AMG



> Find a Retailer



> View the Range Guide

# Driving Assistance package



Active Distance Assist DISTRONIC

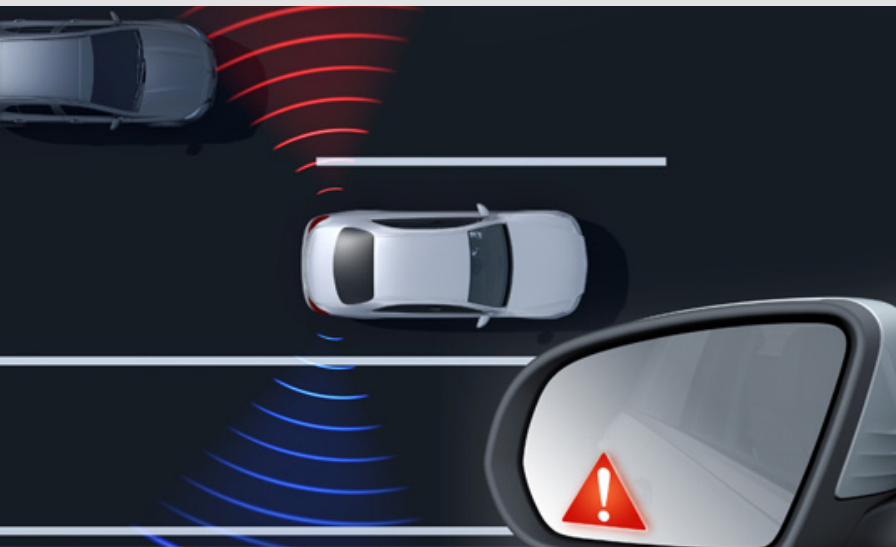

Active Steering Assist

**Driving Assistance package** (code 23P) – designed and priced as a package, including items as listed below.

**AMG Line Night Edition Premium Plus and Mercedes-AMG E 53 4MATIC+ AMG Premium Plus** **Total incl. VAT £1,695.00**

**Driving Assistance package comprises:**

**Active Blind Spot Assist** can warn the driver of vehicles in the blind spot during a lane change and can help to avoid a collision by means of one-sided braking intervention

**Active Braking Assist with cross-traffic function** can help to avoid accidents with vehicles ahead, crossing traffic and also pedestrians, and/or mitigate their consequences

**Active Distance Assist DISTRONIC** helps maintain the desired distance from the vehicle in front

**Active Emergency Stop Assist:** immediate emergency braking if evasion is impossible

**Active Lane Changing Assist** aids the driver with changing lanes by means of steering torque as soon as the driver initiates the change by activating the direction indicator

**Active Lane Keeping Assist**

**Active Speed Limit Assist** ensures detected speed limits are automatically adopted as the set speed for Active Distance Assist DISTRONIC

**Active Steering Assist:** targeted steering intervention to prevent unintentional drifting out of lane

**Evasive Steering Assist** can support the driver in making evasive manoeuvres if, in a dangerous situation, he/she moves to avoid any pedestrian detected by the system

**Extended automatic restart function on motorways**

**PRE-SAFE® PLUS:** when a rear-end collision threatens, PRE-SAFE® PLUS can initiate preventive measures, including warning following traffic and locking the brakes on standstill

**Route-based speed adjustment:** adaption of speed before curves, roundabouts and junctions

# Become the AMG expert

Unleash a new level of performance.

All Mercedes-AMG customers are invited to a complimentary adrenaline-packed driving experience, under the guidance of our driving specialists at Mercedes-Benz World.



## Discover AMG at Mercedes-Benz World

- Individually tailored to your ability
- No previous track experience necessary
- See how well an AMG performs when pushed to its limits
- Put your theoretical driving knowledge to the test on a real track
- Understand the cause and effect of understeer, oversteer drift, collision avoidance and track etiquette
- Get to grips with the Mercedes-Benz World's purpose-built track and dynamic driving facilities

## TERMS AND CONDITIONS

The following customers only are eligible: the first purchaser/registered keeper of a newly registered Mercedes-AMG. The complimentary Training as described in the brochure must be booked and taken within six months of delivery of your Mercedes-AMG. The Training is available Monday to Friday and is subject to availability. Requests for Saturday and Sunday will incur an additional charge. Upgrades are available for an additional cost: details upon request. Transferable to individuals who reside at the same postal address only. Mercedes-Benz Cars UK Limited reserves the right to amend or withdraw this Training experience. Attendees must hold a full UK driving licence. Attendees will be required to sign the Mercedes-Benz World Driving Risk Acknowledgement prior to undertaking the Training experience. The Training experience is also subject to the Mercedes-Benz World Terms and Conditions, as applicable. Invitation is emailed to the customer post-delivery. Permission via the customer contact preferences must be given to enable Mercedes-Benz World to contact. Retailer demonstrator vehicles are not eligible.





View offers > Coupé  
> Cabriolet



Book a test drive > Coupé  
> Cabriolet  
> AMG



> Find a Retailer



> View the Range Guide

# Model prices – Coupé

Model line	Engine	Transmission	CO <sub>2</sub> <sup>1,*</sup>	Basic RRP excl. VAT (£)	Total RRP incl. VAT (£)	Road Fund Licence (£) <sup>2</sup>	Rec. OTR price (£) <sup>3</sup>	P11D value (£)	BiK tax rate 2019/20 (%)
AMG Line Premium	<b>E 220 d</b> Diesel – 1,950 cc, 4-cylinder, 194 hp/143 kW	9G-TRONIC PLUS 9-speed auto.	132	35,779.17	42,935.00	530.00	44,260.00	43,675.00	35
	<b>E 300 d</b> Diesel – 1,950 cc, 4-cylinder, 245hp/180 kW	9G-TRONIC PLUS 9-speed auto.	tba	37,445.83	£44,935.00	tba	tba	tba	tba
	<b>E 300</b> Petrol – 1,991 cc, 4-cylinder, 245hp/180 kW	9G-TRONIC PLUS 9-speed auto.	181	35,895.83	43,075.00	855.00	44,725.00	43,815.00	37
AMG Line Night Edition Premium Plus	<b>E 220 d</b> Diesel – 1,950 cc, 4-cylinder, 194 hp/143 kW	9G-TRONIC PLUS 9-speed auto.	132	37,983.33	45,580.00	530.00	46,905.00	46,320.00	35
	<b>E 300 d</b> Diesel – 1,950 cc, 4-cylinder, 245hp/180 kW	9G-TRONIC PLUS 9-speed auto.	tba	39,650.00	47,580.00	tba	tba	tba	tba
	<b>E 400 d 4MATIC</b> Diesel – 2,925 cc, 6-cylinder, 340hp/250kW	9G-TRONIC PLUS 9-speed auto.	tba	49,233.33	59,080.00	tba	tba	tba	tba
	<b>E 300</b> Petrol – 1,991 cc, 4-cylinder, 245hp/180 kW	9G-TRONIC PLUS 9-speed auto.	181	38,100.00	45,720.00	855.00	47,370.00	46,460.00	37
	<b>E 350</b> Petrol – 1,991 cc, 4-cylinder, 299 hp/220 kW EQ Boost – 14hp/10kW	9G-TRONIC PLUS 9-speed auto.	172	40,800.00	48,960.00	855.00	50,610.00	49,700.00	37
	<b>E 450 4MATIC</b> Petrol – 2,996 cc, 6-cylinder, 367 hp/270 kW	9G-TRONIC PLUS 9-speed auto.	202	46,950.00	56,340.00	1,280.00	58,415.00	57,080.00	37
Mercedes-AMG Premium	<b>Mercedes-AMG E 53 4MATIC+</b> Petrol – 2,999 cc, 6-cylinder, 435 hp/320 kW EQ Boost – 22 hp/16 kW	AMG SPEEDSHIFT TCT 9-speed transmission	202	52,654.17	63,185.00	1,280.00	65,260.00	63,925.00	37
Mercedes-AMG Premium Plus	<b>Mercedes-AMG E 53 4MATIC+</b> Petrol – 2,999 cc, 6-cylinder, 435 hp/320 kW EQ Boost – 22 hp/16 kW	AMG SPEEDSHIFT TCT 9-speed transmission	202	55,562.50	66,675.00	1,280.00	68,750.00	67,415.00	37

<sup>1</sup>The indicated values were determined according to the prescribed measurement method – Worldwide Harmonised Light Vehicle Test Procedure (WLTP). Figures shown may include options which are not available in the UK.

For Battery Electric Vehicles (BEV), figures determined with battery fully charged. These models require mains electricity for charging.

\*CO<sub>2</sub> figures have been converted into NEDC-equivalent values for use with the current VED and BiK tax legislation.

Figures shown are for comparability purposes; only compare with other cars tested to the same technical procedures. Figures may not reflect real life driving results, which will depend upon a number of factors including the starting charge of the battery, factory-fitted options, accessories fitted (post registration), variations in weather, driving styles and vehicle load. Further information about the test used to establish fuel consumption and CO<sub>2</sub> figures can be found at <http://www.mercedes-benz.co.uk/WLTP>

<sup>2</sup>A different first year rate of Vehicle Excise Duty (Road Fund Licence) applies for new cars. Please refer to page 56 for the relevant rate for the second and subsequent years

<sup>3</sup>The recommended on-the-road price includes the Road Fund Licence applicable to the standard model plus delivery charge (£715.00 incl. VAT), new vehicle registration fee (£55.00) and number plates (£25.00 incl. VAT). VAT is calculated at the standard rate of 20%



View offers > Coupé  
> Cabriolet



Book a test drive > Coupé  
> Cabriolet  
> AMG



> Find a Retailer



> View the Range Guide

# Model prices – Cabriolet

Model line	Engine	Transmission	CO <sub>2</sub> <sup>1,*</sup>	Basic RRP excl. VAT (£)	Total RRP incl. VAT (£)	Road Fund Licence (£) <sup>2</sup>	Rec. OTR price (£) <sup>3</sup>	P11D value (£)	BiK tax rate 2019/20 (%)
AMG Line Premium	<b>E 220 d</b> Diesel – 1,950 cc, 4-cylinder, 194 hp/143 kW	9G-TRONIC PLUS 9-speed auto.	139	39,525.00	47,430.00	530.00	48,755.00	48,170.00	36
	<b>E 300 d</b> Diesel – 1,950 cc, 4-cylinder, 245hp/180 kW	9G-TRONIC PLUS 9-speed auto.	148	41,191.67	49,430.00	530.00	50,755.00	50,170.00	37
	<b>E 300</b> Petrol – 1,991 cc, 4-cylinder, 245hp/180 kW	9G-TRONIC PLUS 9-speed auto.	181	39,641.67	47,570.00	855.00	49,220.00	48,310.00	37
AMG Line Night Edition Premium Plus	<b>E 220 d</b> Diesel – 1,950 cc, 4-cylinder, 194 hp/143 kW	9G-TRONIC PLUS 9-speed auto.	139	40,941.67	49,130.00	530.00	50,455.00	49,870.00	36
	<b>E 300 d</b> Diesel – 1,950 cc, 4-cylinder, 245hp/180 kW	9G-TRONIC PLUS 9-speed auto.	148	42,608.33	51,130.00	530.00	52,455.00	51,870.00	37
	<b>E 400 d 4MATIC</b> Diesel – 2,925 cc, 6-cylinder, 340hp/250 kW	9G-TRONIC PLUS 9-speed auto.	tba	52,191.67	62,630.00	tba	tba	tba	tba
	<b>E 300</b> Petrol – 1,991 cc, 4-cylinder, 245hp/180 kW	9G-TRONIC PLUS 9-speed auto.	181	41,058.33	49,270.00	855.00	50,920.00	50,010.00	37
	<b>E 350</b> Petrol – 1,991 cc, 4-cylinder, 299 hp/220 kW EQ Boost – 14hp/10kW	9G-TRONIC PLUS 9-speed auto.	178	43,758.33	52,510.00	855.00	54,160.00	53,250.00	37
Mercedes-AMG Premium	<b>E 450 4MATIC</b> Petrol – 2,996 cc, 6-cylinder, 367 hp/270 kW	9G-TRONIC PLUS 9-speed auto.	202	49,908.33	59,890.00	1,280.00	61,965.00	60,630.00	37
	<b>Mercedes-AMG E 53 4MATIC+</b> Petrol – 2,999 cc, 6-cylinder, 435 hp/320 kW EQ Boost – 22 hp/16 kW	AMG SPEEDSHIFT TCT 9-speed transmission	204	56,400.00	67,680.00	1,280.00	69,755.00	68,420.00	37
Mercedes-AMG Premium Plus	<b>Mercedes-AMG E 53 4MATIC+</b> Petrol – 2,999 cc, 6-cylinder, 435 hp/320 kW EQ Boost – 22 hp/16 kW	AMG SPEEDSHIFT TCT 9-speed transmission	204	58,475.00	70,170.00	1,280.00	72,245.00	70,910.00	37

<sup>1</sup>The indicated values were determined according to the prescribed measurement method – Worldwide Harmonised Light Vehicle Test Procedure (WLTP). Figures shown may include options which are not available in the UK.

For Battery Electric Vehicles (BEV), figures determined with battery fully charged. These models require mains electricity for charging.

\*CO<sub>2</sub> figures have been converted into NEDC-equivalent values for use with the current VED and BiK tax legislation.

Figures shown are for comparability purposes; only compare with other cars tested to the same technical procedures. Figures may not reflect real life driving results, which will depend upon a number of factors including the starting charge of the battery, factory-fitted options, accessories fitted (post registration), variations in weather, driving styles and vehicle load. Further information about the test used to establish fuel consumption and CO<sub>2</sub> figures can be found at <http://www.mercedes-benz.co.uk/WLTP>

<sup>2</sup>A different first year rate of Vehicle Excise Duty (Road Fund Licence) applies for new cars. Please refer to page 56 for the relevant rate for the second and subsequent years

<sup>3</sup>The recommended on-the-road price includes the Road Fund Licence applicable to the standard model plus delivery charge (£715.00 incl. VAT), new vehicle registration fee (£55.00) and number plates (£25.00 incl. VAT). VAT is calculated at the standard rate of 20%





View offers > Coupé  
> Cabriolet



Book a test drive > Coupé  
> Cabriolet  
> AMG



> Find a Retailer



> View the Range Guide

## Pricing summary for model lines

Model	Transmission	Recommended OTR price (£) <sup>1</sup>			
		AMG Line Premium	AMG Line Edition Night Premium Plus	Mercedes-AMG	Mercedes-AMG Premium Plus
<b>Coupé</b>					
E 220 d	9G-TRONIC PLUS 9-speed automatic	44,260.00	46,905.00	-	-
E 300 d	9G-TRONIC PLUS 9-speed automatic	tba	tba	-	-
E 400 d 4MATIC	9G-TRONIC PLUS 9-speed automatic	-	tba	-	-
<hr/>					
E 300	9G-TRONIC PLUS 9-speed automatic	44,725.00	47,370.00	-	-
E 350	9G-TRONIC PLUS 9-speed automatic	-	50,610.00	-	-
E 450 4MATIC	9G-TRONIC PLUS 9-speed automatic	-	58,415.00	-	-
<hr/>					
Mercedes-AMG E 53 4MATIC+	AMG SPEEDSHIFT TCT 9-speed transmission	-	-	65,260.00	68,750.00

<sup>1</sup>The recommended on-the-road price includes the Road Fund Licence applicable to the standard model plus delivery charge (£715.00 incl. VAT), new vehicle registration fee (£55.00) and number plates (£25.00 incl. VAT). VAT is calculated at the standard rate of 20%



View offers > Coupé  
> Cabriolet



Book a test drive > Coupé  
> Cabriolet  
> AMG



> Find a Retailer



> View the Range Guide

Pricing summary for model lines

28

Model	Transmission	Recommended OTR price (£) <sup>1</sup>			
		AMG Line Premium	AMG Line Edition Night Premium Plus	Mercedes-AMG	Mercedes-AMG Premium Plus
<b>Cabriolet</b>					
E 220 d	9G-TRONIC PLUS 9-speed automatic	48,755.00	50,455.00	-	-
E 300 d	9G-TRONIC PLUS 9-speed automatic	50,755.00	52,455.00	-	-
E 400 d 4MATIC	9G-TRONIC PLUS 9-speed automatic	-	tba	-	-
E 300	9G-TRONIC PLUS 9-speed automatic	49,220.00	50,920.00	-	-
E 350	9G-TRONIC PLUS 9-speed automatic	-	54,160.00	-	-
E 450 4MATIC	9G-TRONIC PLUS 9-speed automatic	-	61,965.00	-	-
Mercedes-AMG E 53 4MATIC+	AMG SPEEDSHIFT TCT 9-speed transmission	-	-	69,755.00	72,245.00

<sup>1</sup>The recommended on-the-road price includes the Road Fund Licence applicable to the standard model plus delivery charge (£715.00 incl. VAT), new vehicle registration fee (£55.00) and number plates (£25.00 incl. VAT). VAT is calculated at the standard rate of 20%





View offers > Coupé  
> Cabriolet



Book a test drive > Coupé  
> Cabriolet  
> AMG



> Find a Retailer



> View the Range Guide

## Colours and materials





Book a [▶ Hatchback test drive](#) [▶ AMG](#)



View [▶ Hatchback offers](#) [▶ Saloon](#)



[▶ Find a Retailer](#)



[▶ View the Range Guide](#)

Colours and materials

30

## Non-metallic and metallic paints (standard and optional)

Total prices incl. VAT



149 polar white non-metallic **standard**

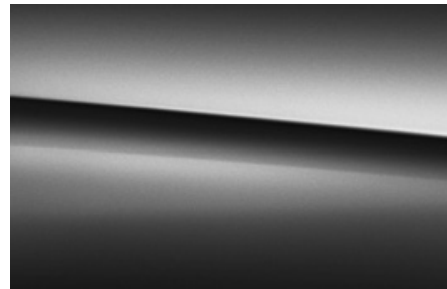

197 obsidian black metallic **£685.00**

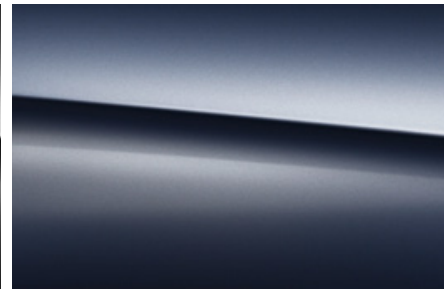

890 cavansite blue metallic **£685.00**

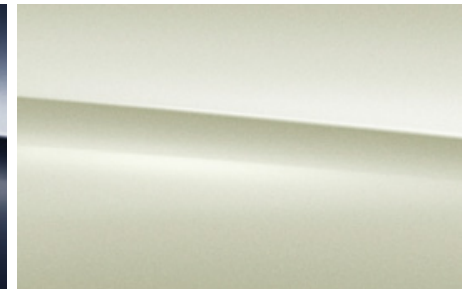

799 designo diamond white metallic **£895.00**

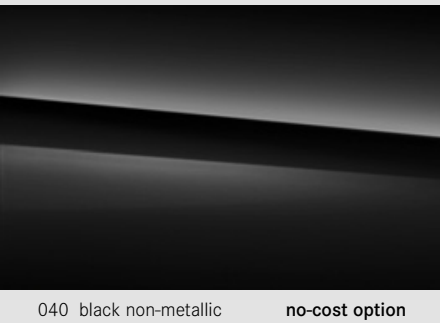

040 black non-metallic **no-cost option**

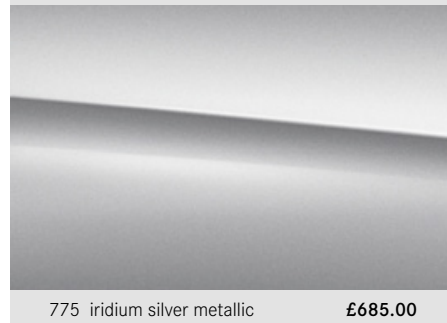

775 iridium silver metallic **£685.00**

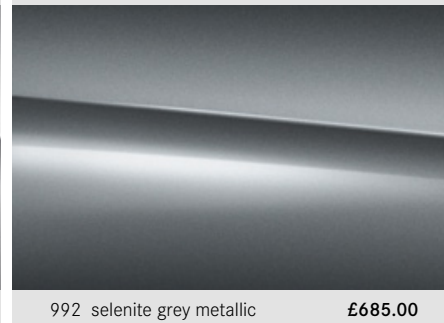

992 selenite grey metallic **£685.00**

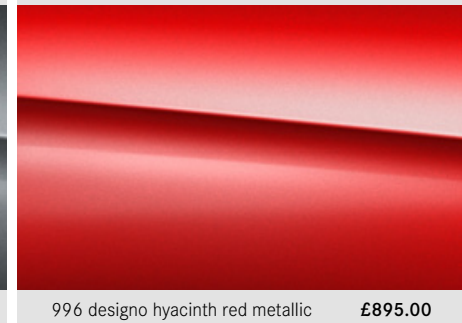

996 designo hyacinth red metallic **£895.00**

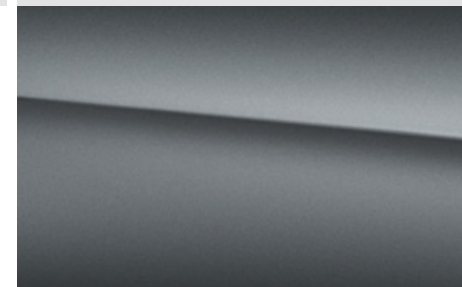

297 designo selenite grey magno<sup>1</sup> **£1,795.00**

<sup>1</sup>designo magno matt paint finishes require extra care. Please refer to the Owner's Manual for instructions

Please note that, owing to limitations of on-screen representation, paint colours may differ from those shown



Book a test drive > Hatchback > AMG



View offers > Hatchback > Saloon



Find a Retailer



View the Range Guide

# Trim



736+737 black open-pore ash wood trim and centre console





View offers > Coupé  
> Cabriolet



Book a test drive > Coupé  
> Cabriolet  
> AMG



> Find a Retailer



> View the Range Guide

# Upholstery



601A ARTICO man-made leather/DINAMICA microfibre – black

AMG Line Premium	●
AMG Line Night Edition Premium Plus	●
<b>Total RRP incl. VAT (£)</b>	-
excl. VAT (£)	-



204A Leather<sup>1</sup> – saddle brown/black

AMG Line Premium	○
AMG Line Night Edition Premium Plus	○
<b>Total RRP incl. VAT (£)</b>	1,095.00
excl. VAT (£)	912.50



211A Leather<sup>1</sup> – black

AMG Line Premium	○
AMG Line Night Edition Premium Plus	○
<b>Total RRP incl. VAT (£)</b>	1,095.00
excl. VAT (£)	912.50



297A Leather<sup>1</sup> – two-tone classic red/black

AMG Line Premium	○
AMG Line Night Edition Premium Plus	○
<b>Total RRP incl. VAT (£)</b>	1,095.00
excl. VAT (£)	912.50



View offers > Coupé  
> Cabriolet



Book a test drive > Coupé  
> Cabriolet  
> AMG



> Find a Retailer



> View the Range Guide

# Upholstery



851A AMG nappa leather<sup>1</sup> – black with red contrast topstitching

Mercedes-AMG E 53 4MATIC+ Premium	●
Mercedes-AMG E 53 4MATIC+ Premium Plus	●
<b>Total RRP incl. VAT (£)</b>	-
excl. VAT (£)	-



884A AMG nappa leather<sup>1</sup> – two-tone black/saddle brown

Mercedes-AMG E 53 4MATIC+ Premium	○
Mercedes-AMG E 53 4MATIC+ Premium Plus	○
<b>Total RRP incl. VAT (£)</b>	-
excl. VAT (£)	no-cost option



887A AMG nappa leather<sup>1</sup> – two-tone classic red/black

Mercedes-AMG E 53 4MATIC+ Premium	○
Mercedes-AMG E 53 4MATIC+ Premium Plus	○
<b>Total RRP incl. VAT (£)</b>	-
excl. VAT (£)	no-cost option

● Standard ○ Optional - Not available <sup>1</sup>At least 80% of the seat upholstery is pure leather, while up to 20% may consist of man-made leather



View offers > Coupé  
> Cabriolet



Book a test drive > Coupé  
> Cabriolet  
> AMG



> Find a Retailer



> View the Range Guide

## Soft-top colours (Cabriolet only)



740 black



744 dark blue



746 dark red





View offers > Coupé  
> Cabriolet



Book a test drive > Coupé  
> Cabriolet  
> AMG



> Find a Retailer



> View the Range Guide

# Wheels



**RTD** 19" alloy wheels (4) – 5-twin-spoke design, painted titanium grey with high-shine finish  
front: 245/40 tyres; rear: 275/35 tyres

AMG Line Premium	●
AMG Line Night Edition Premium Plus	-
Mercedes-AMG E 53 4MATIC+ Premium	-
Mercedes-AMG E 53 4MATIC+ Premium Plus	-



**RVR** 20" alloy wheels (4) – multi-spoke design, painted high-gloss black with high-shine finish  
front: 245/35 tyres; rear: 275/30 tyres

AMG Line Premium	-
AMG Line Night Edition Premium Plus	●
Mercedes-AMG E 53 4MATIC+ Premium	-
Mercedes-AMG E 53 4MATIC+ Premium Plus	-



View offers > Coupé  
> Cabriolet



Book a test drive > Coupé  
> Cabriolet  
> AMG



> Find a Retailer



> View the Range Guide



**RTE** 19" AMG alloy wheels (4) – 5-twin-spoke design, painted high-gloss black with high-shine finish  
front: 245/40 tyres; rear: 275/35 tyres

AMG Line Premium	-
AMG Line Night Edition Premium Plus	-
Mercedes-AMG E 53 4MATIC+ Premium	●
Mercedes-AMG E 53 4MATIC+ Premium Plus	-



**RTZ** 20" AMG alloy wheels (4) – 5-twin-spoke design, painted black with high-shine finish  
front: 245/35 tyres; rear: 275/30 tyres

AMG Line Premium	-
AMG Line Night Edition Premium Plus	-
Mercedes-AMG E 53 4MATIC+ Premium	-
Mercedes-AMG E 53 4MATIC+ Premium Plus	●



# Standard equipment

## Item

### Engine, Transmission and Suspension

	AMG Line Premium	AMG Line Night Edition Premium Plus	E53 4MATIC+ Premium	E53 4MATIC+ Premium Plus
9G-TRONIC 9-speed automatic transmission	●	●	-	-
AGILITY CONTROL suspension with selective damping system and lowering by 15 mm	●	●	-	-
AMG DYNAMIC SELECT with a choice of driving modes: Comfort, Sport, Sport+ and Individual	-	-	●	●
AMG RIDE CONTROL sports suspension based on AIR BODY CONTROL air suspension – the multi-chamber air suspension system with a sporty spring/damper set-up continuously adjusts damping to ensure excellent driving dynamics and a high level of ride comfort. In combination with AMG DYNAMIC SELECT, three pre-set modes (Comfort, Sport and Sport+) are available to deliver a tailored drive experience	-	-	●	●
AMG SPEEDSHIFT TCT 9-speed transmission	-	-	●	●
DYNAMIC SELECT with a choice of driving modes: ECO, Comfort, Sport, Sport+ and Individual	●	●	-	-
ECO start/stop function	●	●	●	●
EQ Boost starter-alternator	-	-	●	●

## Item

### Exterior

	AMG Line Premium	AMG Line Night Edition Premium Plus	E53 4MATIC+ Premium	E53 4MATIC+ Premium Plus
KEYLESS-GO Comfort package – including hands-free access, automatic powered boot closing and keyless entry	-	●	-	●
Mirror package – electrically folding mirrors and automatically-dimming exterior driver's mirror and rear-view mirror	●	●	●	●
Parking package with 360° camera	●	●	●	●
14-litre AdBlue tank (Cabriolet only)	●	●	-	-
25-litre AdBlue tank (Coupé only)	●	●	-	-
66-litre fuel tank	●	●	●	●
Acoustic soft-top – with enhanced climate and noise comfort (Cabriolet only)	●	●	●	●
AIRCAP – wind deflector and draught-stop (Cabriolet only)	●	●	●	●
AIRSCARF – neck-level heating system (Cabriolet only)	●	●	●	●
AMG bodystyling – front and rear aprons, side skirts	●	●	●	●
AMG boot lid spoiler in body colour	●	●	●	●
AMG performance exhaust system	-	-	●	●
Badging – 'BITURBO 4MATIC+' lettering on front wings	-	-	●	●
Exterior mirrors – heated and electronically adjustable	●	●	●	●





View offers > Coupé  
> Cabriolet



Book a test drive > Coupé  
> Cabriolet  
> AMG



> Find a Retailer



> View the Range Guide

Item	AMG Line Premium	AMG Line Night Edition Premium Plus	E53 4MATIC+ Premium	E53 4MATIC+ Premium Plus
<b>Exterior (continued)</b>				
Headlamps – MULTIBEAM LED Intelligent Light System with Adaptive Highbeam Assist	●	●	●	●
Panoramic glass sunroof – the electric panoramic sliding sunroof covers two thirds of the roof area (Coupé only)	–	●	–	●
Perforated front brake discs with 'Mercedes-Benz' lettering	●	●	–	–
Perforated front brake discs and anodised silver brake calipers with 'AMG' lettering	–	–	●	●
Pre-installation for roof rail systems (Coupé only)	●	●	●	●
Privacy glass (Coupé only) – includes rear side windows and rear windscreen	●	●	●	●
Radiator grille with integrated star – louvre in matt iridium silver with chrome trim	●	●	–	–
Rain-sensing windscreen wipers (replacing Magic Vision Control)	●	●	●	●
Rear lights – LED	●	●	●	●
Run-flat tyres	●	●	–	–
Fully-automatic boot separator (Cabriolet only)	●	●	●	●
Sports exhaust system (only available for E 300 engines)	–	–	–	–
TIREFIT with tyre inflation compressor	–	–	●	●
Top surround of side windows in polished aluminium	●	●	●	●
Visible twin-pipe exhaust system integrated into bumper	●	●	–	–
Visible two twin-pipe exhaust system integrated into the bumper	–	–	●	●
Waistline in polished aluminium	●	●	●	●

● Standard – Not available

Standard equipment

38

Item	AMG Line Premium	AMG Line Night Edition Premium Plus	E53 4MATIC+ Premium	E53 4MATIC+ Premium Plus
<b>Interior</b>				
Memory package – driver's seat, front passenger seat, steering column and exterior mirrors – electrically adjustable with memory; includes electro-pneumatic four-way lumbar support and seat cushion depth adjustment (6 cm)	●	●	●	●
Seat Comfort package – driver and front passenger seat – electric adjustment of seat cushion inclination, height and backrest, electro-pneumatic four-way lumbar support and manual seat cushion depth (6 cm), fore/aft and headrest adjustment	●	●	●	●
Stowage package – bag hooks under parcel shelf, folding box and net on luggage compartment floor, double cup holder in centre console 2x750ml, double cup holder between two rear seats, tensioning strap in stowage compartment in centre console, map pockets on rear of front seats, nets beneath rear seat cushions for stowage of flat objects	●	●	●	●
Analogue clock on centre console	●	●	●	●
Automatic climate control – two-zone	●	●	●	●
Belt feeder – driver and front passenger seat belt automatically positioned within easier reach	●	●	●	●
Central stowage compartment with 12 V socket in centre console	●	●	–	–
Central stowage compartment with USB socket for use with Android Auto and Apple CarPlay™	●	●	●	●
Door pins in chrome	●	●	●	●
Electric windows (4) – with one-touch opening and closing, including obstruction sensors	●	●	●	●
Electronic key – chrome surround	●	●	●	●



Item	AMG Line Premium	AMG Line Night Edition Premium Plus	E53 4MATIC+ Premium	E53 4MATIC+ Premium Plus
<b>Interior (continued)</b>				
Floor mats with 'AMG' lettering	●	●	●	●
Front centre armrest with stowage compartment	●	●	●	●
Front door sill panels with 'AMG' lettering – illuminated	–	–	●	●
Front door sill panels with 'Mercedes-Benz' lettering – illuminated	●	●	–	–
Glasses compartment in overhead control panel	●	●	●	●
Glove compartment – lockable, air-conditioned and illuminated	●	●	●	●
Head restraints for driver and front passenger (four-way adjustability) and in rear (two-way)	●	●	●	●
Instrument cluster – widescreen (12.3-inch) cockpit display – high resolution screen with choice of three display styles	●	●	●	●
Instrument cluster – AMG main menu, including RACETIMER and AMG start-up display – displays valuable information for sporty drivers presented in an inspiring AMG design. With RACETIMER it is possible to measure lap times	–	–	●	●
Interior 64-colour ambient lighting – dynamic multicolour LED lighting of trim on dashboard, centre console and door panelling; and in door pockets, cup holder, stowage compartment and rear footwell – 10 colour palettes with various colour combinations, climate control effects with colour feedback, three unique ambient lighting settings based on display styles 'Classic', 'Progressive' or 'Sport' in conjunction with widescreen (12.3-inch) cockpit display and welcome light effect upon entry to cabin	●	●	●	●
KEYLESS-GO starting function	●	–	●	–

● Standard – Not available

Standard equipment

39

Item	AMG Line Premium	AMG Line Night Edition Premium Plus	E53 4MATIC+ Premium	E53 4MATIC+ Premium Plus
Outside temperature display	●	●	●	●
Seats – front, AMG sports seats – more pronounced contouring of front seats for enhanced lateral support, with AMG badging in seat backrests. AMG-specific upholstery layout	–	–	●	●
Seats – front, heated	●	●	●	●
Seats – rear, split folding 40:20:40 (Coupé only)	●	●	●	●
Seats – rear, split folding 50:50 (Cabriolet only)	●	●	●	●
Service indicator ASSYST	●	●	●	●
Sports pedals in brushed stainless steel with black rubber studs	●	●	●	●
Sun visors with illuminated vanity mirrors	●	●	●	●
Trip computer in multifunction display showing current fuel consumption	●	●	●	●
<b>Steering</b>				
Direct-Steer speed sensitive steering	●	●	–	–
Steering column – manually adjustable for height and reach	●	●	–	–
Steering column – electrically adjustable for height and reach	–	–	●	●
Steering wheel – 3-spoke design with flattened bottom section, steering wheel trim in silver chrome with 'AMG' lettering and silver-coloured aluminium gearshift paddles, 12 o'clock marking and Touch Control buttons	–	–	●	●



Item	AMG Line Premium	AMG Line Night Edition Premium Plus	E53 4MATIC+ Premium	E53 4MATIC+ Premium Plus
<b>Steering (continued)</b>				
Steering wheel – 3-spoke multifunction AMG steering wheel with Touch Control buttons, trimmed in black nappa leather with flattened bottom section	●	●	–	–
Steering wheel – with gearshift paddles	●	●	●	●
Steering wheel – touch control buttons for audio and onboard settings	●	●	●	●
<b>Paint, Trim and Upholstery</b>				
Paint – non metallic	●	●	●	●
Trim – centre console, open-pore black ash wood	●	●	●	●
Trim – dashboard and door, black open-pore ash wood	●	●	●	●
Trim – upper dashboard, ARTICO man-made leather with contrasting stitching	●	●	●	●
Upholstery – ARTICO man-made leather/DINAMICA microfibre	●	●	–	–
Upholstery – nappa leather	–	–	●	●
<b>Security and Safety</b>				
Active bonnet – pedestrian safety measure which detects an impact and raises bonnet	●	●	●	●
Active Brake Assist	●	●	●	●
Active Parking Assist including front and rear parking sensors – the system automatically steers the vehicle into parking spaces. Bay and parallel parking capable	●	●	●	●
Adaptive brake lights	●	●	●	●
Adaptive brake system with HOLD function and brake drying in the wet	●	●	●	●

● Standard – Not available

Item	AMG Line Premium	AMG Line Night Edition Premium Plus	E53 4MATIC+ Premium	E53 4MATIC+ Premium Plus
<b>Standard equipment</b>				
Airbag – kneebag for driver	●	●	●	●
Airbags – driver and front passenger, with extended adaptivity for front passenger airbag	●	●	●	●
Airbags – headbags	●	●	●	●
Airbags – sidebag for driver and front passenger (combined thorax/pelvis bag)	●	●	●	●
Airbags – windowbags	●	●	●	●
Alarm system with immobiliser and interior protection	●	●	●	●
Anti-lock braking system (ABS)	●	●	●	●
ATTENTION ASSIST – can help alert to long journey fatigue	●	●	●	●
Automatic child seat recognition sensor	●	●	●	●
Blind Spot Assist	●	●	●	●
Brake wear warning display	●	●	●	●
Central locking with interior switch, automatic locking and crash sensor with emergency opening function	●	●	●	●
Cruise control with variable speed limiter	●	●	●	●
Diesel Particulate Filter (DPF) (only available for E 220 d and E 400 d engines)	●	●	–	–
Electric parking brake	●	●	●	●
Electronic Stability Programme (ESP®)	●	●	●	●
First-aid kit and warning triangle	●	●	●	●





Item	AMG Line Premium	AMG Line Night Edition Premium Plus	E53 4MATIC+ Premium	E53 4MATIC+ Premium Plus
<b>Security and Safety (continued)</b>				
Incorrect fuelling protection (only available for E 220 d and E 400 d engines)	●	●	-	-
ISOFIX child seat attachment points - rear seats	●	●	●	●
PRE-SAFE® anticipatory safety system	●	●	●	●
Remote boot release	●	●	●	●
Seat belts - three-point	●	●	●	●
Seat occupancy sensor for front passenger seat	●	●	●	●
Status display for rear seat belts in instrument cluster	●	●	●	●
Traffic Sign Assist - Traffic sign recognition including wrong-way warning function and display of posted speed limits in the instrument cluster	●	●	●	●
Tyre pressure monitoring system	●	●	●	●
<b>Communications and In-Car Entertainment</b>				
Burmester® surround sound system - 13 speakers and a 9-channel amplifier with total output of 590 watts	-	●	-	●
COMAND Online system <sup>1</sup> with Media Interface and touchpad - fast hard disk navigation with instructions shown on 12.3-inch high-resolution colour display and in the instrument cluster. Includes 3D views with visualisation of roads and buildings as well as junctions and lane assistants, making it easy for drivers to orientate themselves. Spoken instructions are emitted through vehicle's built-in speakers. WLAN/Wi-Fi hotspot for connecting up to three mobile devices. Car-to-X Communication exchanging the latest traffic information between appropriately equipped vehicles, warns of broken down vehicles and other hazards on the route	●	●	●	●

Item	AMG Line Premium	AMG Line Night Edition Premium Plus	E53 4MATIC+ Premium	E53 4MATIC+ Premium Plus
<b>Standard equipment</b>				
DAB digital radio	●	●	●	●
High-resolution 12.3-inch multimedia colour display	●	●	●	●
Live Traffic Information (free for first three years)	●	●	●	●
Mercedes me connect (standard services) - including emergency call system (eCall), accident recovery, breakdown and maintenance management	●	●	●	●
Pre-installation for Vehicle Monitoring	●	●	●	●
Pre-installation for Vehicle Setup	●	●	●	●
Smartphone integration via Android Auto or Apple CarPlay™, Media Interface, USB and Bluetooth® interface	●	●	●	●
Touchpad with control wheel	●	●	●	●
USB ports (2) in centre console	●	●	●	●
USB ports (2) in the rear	●	●	●	●
Wireless charging <sup>2</sup>	●	●	●	●



View offers > Coupé  
> Cabriolet



Book a test drive > Coupé  
> Cabriolet  
> AMG



> Find a Retailer



> View the Range Guide

# ServiceCare

Item	Notes							Basic RRP excl. VAT (£)	Total RRP incl. VAT (£)
Service Package		AMG Line Premium	AMG Line Night Edition Premium Plus	E53 4MATIC+ Premium	E53 4MATIC+ Premium Plus				
ServiceCare ServiceCare allows you to spread the cost of servicing your new car in the Mercedes-Benz Retailer network. Taking out a ServiceCare plan ensures your servicing needs are taken care of by fully-trained Mercedes-Benz Technicians with the added benefit of a Mercedes-Benz service history	Price is based on a monthly rate. Example given is for two services taken over 24 months; three services over 36 months; or four services over 48 months. Further payment options are available. New ServiceCare prices apply only to vehicles up to 12 months old prior to first service	1	<input type="radio"/>	<input type="radio"/>	<input type="radio"/>	<input type="radio"/>		28.33	34.00



View offers > Coupé  
> Cabriolet



Book a test drive > Coupé  
> Cabriolet  
> AMG



> Find a Retailer



> View the Range Guide

## Genuine Accessories

We've developed a range of Accessories you can add to help personalise and enhance your E-Class. Your local Mercedes-Benz Retailer can advise on fitting costs of Accessories, where applicable. Further information on our full range of Genuine Accessories can be found **here** on the Mercedes-Benz UK website.

### 01 | LED projectors, Mercedes star, two-piece (A2178206800)

Innovative LED projectors project a Mercedes star with a 3D effect onto the ground in the entrance area when opening the driver or front passenger door.

RRP £154.80 (incl. VAT) per pair, excluding fitting

### 02 | Door handle recesses, large, two-piece (A2057604000)

Chrome-design door handle recesses lend the vehicle a polished, individual look. The stable, robust material is precision-tailored to the bodywork and protects the paintwork in the recess from scratches. Set of two.

RRP £41.50 (incl. VAT), excluding fitting







View offers > Coupé  
> Cabriolet



Book a test drive > Coupé  
> Cabriolet  
> AMG



> Find a Retailer



> View the Range Guide

### 03 | Rear spoiler (A2387930000)

The rear spoiler from Mercedes-Benz significantly boosts the car's aerodynamics. Harmoniously tailored to the contours of the vehicle, the rear spoiler rounds off the sporty design and the top-class materials used to create the rear spoiler ensure a high-quality feel. Coupé only.

RRP £362.40 (incl. VAT)

### 04 | Exterior mirror housing, high-gloss black (A2138111100)

Mercedes-Benz Sport Equipment exterior mirror housings for enhanced aerodynamics and an individual, sporty and dynamic look.

RRP £175.20 (incl. VAT)

### 05 | Concertina load sill protector (A2536932000)

The concertina load sill protector prevents the bumper and boot sill from become scratched. The protector can be attached via hooks to the lifting eyes or can be attached via a velcro strip to the reversible mat or roof box. Simple and versatile.

RRP £41.50 (incl. VAT)





View offers > Coupé  
> Cabriolet



Book a test drive > Coupé  
> Cabriolet  
> AMG



> Find a Retailer



> View the Range Guide

**06 | Velour floor mats, designo, four-piece set (A23868075029F87)**

Floor mats have to undergo rigorous testing before they are deemed worthy of the star logo: durability, fade-resistant colour and a neutral odour, even after three winters of use, are all specifications which must be met without compromise. The mats are precision-tailored to your Mercedes-Benz using the vehicle's original CAD data. Can be clip-fastened to the floor to prevent slipping.

RRP £284.40 (incl. VAT)

**07 | Coolbox (A0008204206)**

Warm and cool at your convenience with the Mercedes-Benz cool box. Cooling as low as  $-2^{\circ}\text{C}$  and with a capacity of 24 litres this serves as the perfect travel companion. The cool box is powered via the cigarette lighter or a 12-volt socket and can be secured in the vehicle via the carrying strap.

RRP £170.50 (incl. VAT)

**08 | Picnic hamper (B66041562)**

Ideal for lunch in nature: the dark brown picnic hamper made from Polyrattan impresses with a practical attachment of glasses, cups and plates with the help of straps and Velcro fasteners. The content of the hamper is set out for two people: two four-part cutlery sets, two porcelain plates, coffee cups, juice glasses, a salt and a pepper shaker, two serviettes and a  $140 \times 140$  cm table cloth. Dimensions: approx.  $50 \times 34 \times 31$  cm

RRP £272.40 (incl. VAT)



06



07



08



## Technical data – Coupé

Model	Diesel engines			Petrol engines				
	E 220 d	E 300 d	E 400 d 4MATIC	E 300	E 350	E 450 4MATIC	Mercedes-AMG E 53 4MATIC+	
<b>Engine</b>								
Total displacement	cc	1,950	1,950	2,925	1,991	1,991	2,996	2,999
Arrangement/cylinders/valves		in-line/4/16	in-line/4/16	in-line/6/24	in-line/4/16	in-line/4/16	V/6/24	in-line/6/24
Fuel delivery		Common-rail diesel with turbocharger	Common-rail diesel with turbocharger	Common-rail diesel with turbocharger	Electronically controlled direct injection with turbocharger	Electronically controlled direct injection with turbocharger	Electronically controlled direct injection with twin turbochargers	Electronically controlled direct injection with twin turbocharger
Power <sup>1</sup>	hp (kW) at rpm	194 (143)/3,800	245 (180)/3,800	340 (250)/3,600-4,400	245 (180)/5,500	299 (220)/5,800-6,100	367 (270)/5,250-6,000	435 (320)/6,100
Torque <sup>1</sup>	Nm at rpm	400/1,600-2,800	500/1,600-2,400	700/1,200-3,200	370/1,300-4,000	400/3,000-4,000	500/1,800-4,500	520/1,800-5,800
Compression ratio		15.5:1	15.5:1	15.5:1	9.8:1	10.0:1	10.5:1	10.5:1
<b>Transmission</b>								
9G-TRONIC PLUS 9-speed automatic		●	●	●	●	●	●	-
AMG SPEEDSHIFT TCT 9-speed transmission		-	-	-	-	-	-	●





View offers > Coupé  
> Cabriolet



Book a test drive > Coupé  
> Cabriolet  
> AMG



> Find a Retailer



> View the Range Guide

Model	Diesel engines			Petrol engines			
	E 220 d	E 300 d	E 400 d 4MATIC	E 300	E 350	E 450 4MATIC	Mercedes-AMG E 53 4MATIC+

#### Tyre sizes

Front	245/40 R 19	245/40 R 19	245/40 R 19	245/40 R 19	245/40 R 19	245/40 R 19	245/40 R 19
Rear	275/35 R 19	275/35 R 19	275/35 R 19	275/35 R 19	275/35 R 19	275/35 R 19	275/35 R 19

#### Performance

Acceleration 0–62 mph	sec	7.4	6.3	5.1	6.5	5.9	5.6	4.4
Top speed	mph	150	155	155 <sup>2</sup>	155 <sup>2</sup>	155 <sup>2</sup>	155 <sup>2</sup>	155 <sup>2</sup>

#### Weights and capacities

Kerb weight <sup>3</sup>	kg	1,735	1,810	1,865	1,685	1,735	1,860	1,970
Perm. GVW	kg	2,300	2,340	2,440	2,250	2,250	2,365	2,425
Load capacity	l	425	425	425	425	405	425	425
Towing capacity – unbraked		750	750	750	750	750	750	750
braked	kg	1,800	1,800	1,800	1,800	1,800	1,800	1,900
Fuel tank capacity/reserve	l	66/7	66/7	66/7	66/7	66/7	66/7	66/7
Turning circle	m	11.37	11.0	11.61	11.37	11.37	11.61	12.10

<sup>2</sup>Electronically limited

<sup>3</sup>Figures according to Directive 92/21/EC (kerb weight with fuel tank 90% full, driver, 68 kg, and luggage, 7 kg) for standard-specification vehicles. Optional extras and accessories will generally increase this figure and reduce the payload capacity accordingly



View offers > Coupé  
> Cabriolet



Book a test drive > Coupé  
> Cabriolet  
> AMG



> Find a Retailer



> View the Range Guide

Model	Diesel engines			Petrol engines			
	E 220 d	E 300 d	E 400 d 4MATIC	E 300	E 350	E 450 4MATIC	Mercedes-AMG E 53 4MATIC+

**Fuel consumption<sup>4,5,6</sup>**

Combined (consumption dependent on chosen optional equipment) l/100 km mpg	5.4–6.5 52.3–43.5	5.9–6.8 47.9–41.5	6.7–7.4 42.2–38.2	9.1 31	7.6–8.6 37.2–32.8	9.0–9.7 31.4–29.1	9.0–9.4 31.4–30.1
--	----------------------	----------------------	----------------------	-----------	----------------------	----------------------	----------------------

**CO<sub>2</sub> emissions<sup>5,6,\*</sup>**

g/km

Emissions standard	EU6	EU6	EU6	EU6	EU6	EU6	EU6
19" alloy wheels (275/35 tyres)	132	tba	–	181	–	–	–
20" alloy wheels (275/30 tyres)	132	tba	158	181	164	202	202

**Insurance**

Base model	34	tba	tba	37	39	tba	tba
------------	----	-----	-----	----	----	-----	-----

Insurance ratings may vary depending on model line and specification. Please refer to <http://www.thatcham.org/abigrouprating/> for further details

<sup>4</sup>All figures are based on a standard specification with the smallest tyre size <sup>5</sup>The choice of wheels and transmission may affect CO<sub>2</sub> emissions and corresponding Road Fund Licence

<sup>6</sup>The indicated values were determined according to the prescribed measurement method – Worldwide Harmonised Light Vehicle Test Procedure (WLTP). Figures shown may include options which are not available in the UK.

For Battery Electric Vehicles (BEV), figures determined with battery fully charged. These models require mains electricity for charging

\*CO<sub>2</sub> figures have been converted into NEDC-equivalent values for use with the current VED and BIK tax legislation.

Figures shown are for comparability purposes; only compare with other cars tested to the same technical procedures. Figures may not reflect real life driving results, which will depend upon a number of factors including the starting charge of the battery, factory-fitted options, accessories fitted (post registration), variations in weather, driving styles and vehicle load. Further information about the test used to establish fuel consumption and CO<sub>2</sub> figures can be found at <http://www.mercedes-benz.co.uk/WLTP>



View offers > Coupé  
> Cabriolet



Book a test drive > Coupé  
> Cabriolet  
> AMG



> Find a Retailer



> View the Range Guide

## AMG Line

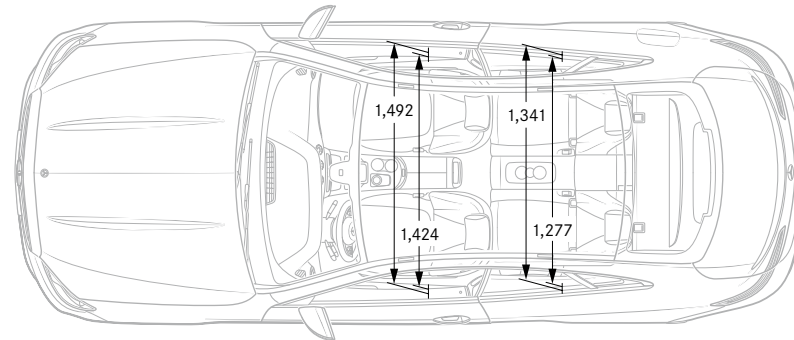
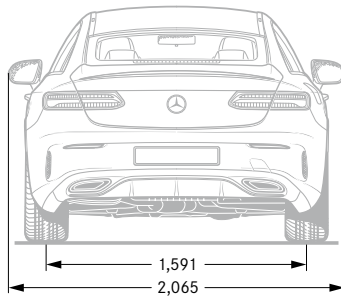
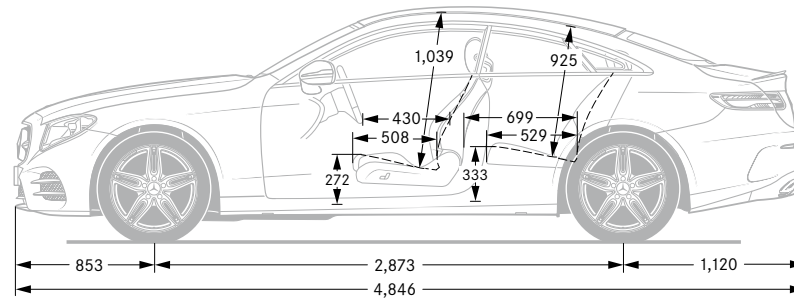
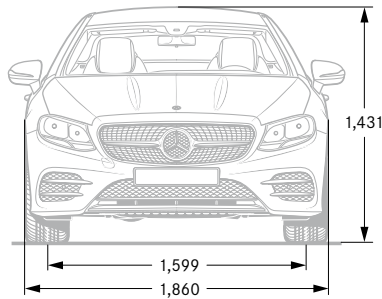





View offers > Coupé  
> Cabriolet



Book a test drive > Coupé  
> Cabriolet  
> AMG



> Find a Retailer



> View the Range Guide

## Mercedes-AMG E 53 4MATIC+

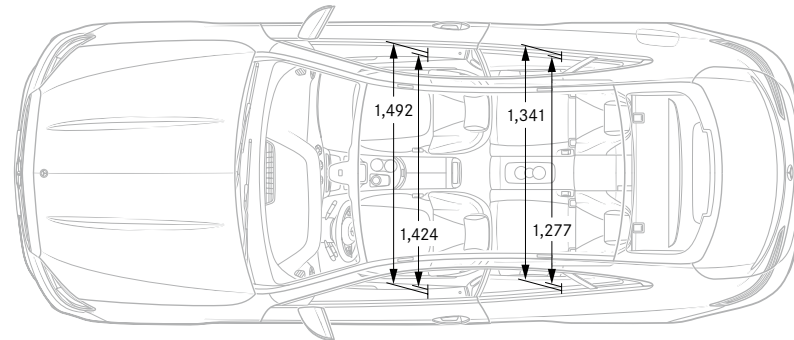
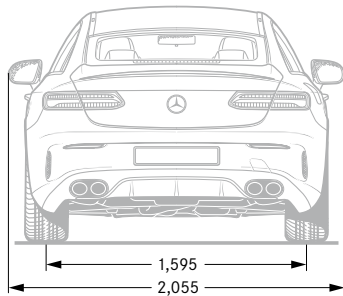
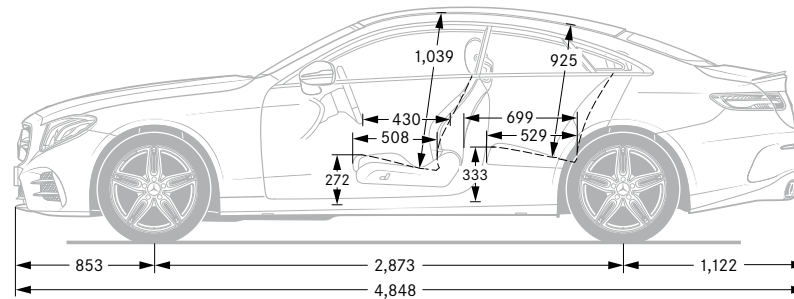
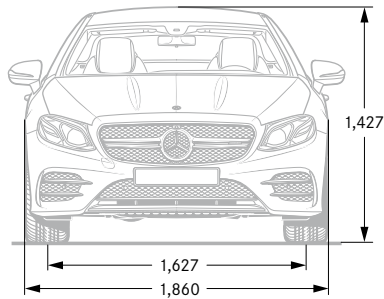



## Technical data – Cabriolet

Model	Diesel engines			Petrol engines				
	E 220 d	E 300 d	E 400 d 4MATIC	E 300	E 350	E 450 4MATIC	Mercedes-AMG E 53 4MATIC+	
<b>Engine</b>								
Total displacement	cc	1,950	1,950	2,925	1,991	1,991	2,996	2,999
Arrangement/cylinders/valves		in-line/4/16	in-line/4/16	in-line/6/24	in-line/4/16	in-line/4/16	V/6/24	in-line/6/24
Fuel delivery		Common-rail diesel with turbocharger	Common-rail diesel with turbocharger	Common-rail diesel with turbocharger	Electronically controlled direct injection with turbocharger	Electronically controlled direct injection with turbocharger	Electronically controlled direct injection with twin turbochargers	Electronically controlled direct injection with twin turbocharger
Power <sup>1</sup>	hp (kW) at rpm	194 (143)/3,800	245 (180)/4,200–4,600	340 (250)/3,600–4,600	245 (180)/5,500	299 (220)/5,800–6,100	367 (270)/5,500–6,000	435 (320)/6,100
Torque <sup>1</sup>	Nm at rpm	400/1,600–2,800	400/1,600–2,800	700/1,200/3,200	370/1,300–4,000	400/3,000–4,000	500/1,800–4,500	520/1,800–5,800
Compression ratio		15.5:1	15.5:1	15.5:1	9.8:1	10.0:1	10.5:1	10.5:1
<b>Transmission</b>								
9G-TRONIC PLUS 9-speed automatic		●	●	●	●	●	●	–
AMG SPEEDSHIFT TCT 9-speed transmission		–	–	–	–	–	–	●



View offers > Coupé  
> Cabriolet



Book a test drive > Coupé  
> Cabriolet  
> AMG



> Find a Retailer



> View the Range Guide

Model	Diesel engines			Petrol engines			
	E 220 d	E 300 d	E 400 d 4MATIC	E 300	E 350	E 450 4MATIC	Mercedes-AMG E 53 4MATIC+

#### Tyre sizes

Front	245/40 R 19	245/40 R 19	245/40 R 19	245/40 R 19	245/40 R 19	245/40 R 19	245/40 R 19
Rear	275/35 R 19	275/35 R 19	275/35 R 19	275/35 R 19	275/35 R 19	275/35 R 19	275/35 R 19

#### Performance

Acceleration 0–62 mph	sec	7.7	6.6	5.2	6.6	6.1	5.8	4.5
Top speed	mph	147	155 <sup>2</sup>	155 <sup>2</sup>	155 <sup>2</sup>	155 <sup>2</sup>	155 <sup>2</sup>	155 <sup>2</sup>

#### Weights and capacities

Kerb weight <sup>3</sup>	kg	1,830	1,875	2,010	1,795	1,820	1,950	2,055
Perm. GVW	kg	2,335	2,355	2,465	2,280	2,290	2,420	2,475
Load capacity	l	385	385	385	385	360	385	385
Towing capacity – unbraked braked		750	750	750	750	750	750	750
	kg	1,800	1,800	1,800	1,800	1,800	1,800	1,900
Fuel tank capacity/reserve	l	66/7	66/7	66/7	66/7	66/7	66/7	66/7
Turning circle	m	11.37	11.00	11.61	11.37	11.37	11.61	12.10

<sup>2</sup>Electronically limited

<sup>3</sup>Figures according to Directive 92/21/EC (kerb weight with fuel tank 90% full, driver, 68 kg, and luggage, 7 kg) for standard-specification vehicles. Optional extras and accessories will generally increase this figure and reduce the payload capacity accordingly





View offers > Coupé  
> Cabriolet



Book a test drive > Coupé  
> Cabriolet  
> AMG



> Find a Retailer



> View the Range Guide

Model	Diesel engines			Petrol engines			
	E 220 d	E 300 d	E 400 d 4MATIC	E 300	E 350	E 450 4MATIC	Mercedes-AMG E 53 4MATIC+

**Fuel consumption<sup>4,5,6</sup>**

Combined (consumption dependent on chosen optional equipment) l/100 km mpg	5.6–6.6 50.4–42.8	6.1–6.9 46.3–40.9	6.9–7.5 40.9–37.7	9.1 31	7.8–8.7 36.2–32.5	9.0–9.9 31.4–28.5	9.2–9.5 30.7–29.7
--	----------------------	----------------------	----------------------	-----------	----------------------	----------------------	----------------------

**CO<sub>2</sub> emissions<sup>5,6,\*</sup>**

g/km

Emissions standard	EU6	EU6	EU6	EU6	EU6	EU6	EU6
19" alloy wheels (275/35 tyres)	139	148	–	181	–	–	–
20" alloy wheels (275/30 tyres)	139	148	162	181	170	202	204

**Insurance**

Base model	40	tba	tba	42	43	tba	tba
------------	----	-----	-----	----	----	-----	-----

Insurance ratings may vary depending on model line and specification. Please refer to <http://www.thatcham.org/abigrouprating/> for further details

<sup>4</sup>All figures are based on a standard specification with the smallest tyre size <sup>5</sup>The choice of wheels and transmission may affect CO<sub>2</sub> emissions and corresponding Road Fund Licence

<sup>6</sup>The indicated values were determined according to the prescribed measurement method – Worldwide Harmonised Light Vehicle Test Procedure (WLTP). Figures shown may include options which are not available in the UK.

For Battery Electric Vehicles (BEV), figures determined with battery fully charged. These models require mains electricity for charging

\*CO<sub>2</sub> figures have been converted into NEDC-equivalent values for use with the current VED and BIK tax legislation.

Figures shown are for comparability purposes; only compare with other cars tested to the same technical procedures. Figures may not reflect real life driving results, which will depend upon a number of factors including the starting charge of the battery, factory-fitted options, accessories fitted (post registration), variations in weather, driving styles and vehicle load. Further information about the test used to establish fuel consumption and CO<sub>2</sub> figures can be found at <http://www.mercedes-benz.co.uk/WLTP>



View offers > Coupé  
> Cabriolet



Book a test drive > Coupé  
> Cabriolet  
> AMG



> Find a Retailer



> View the Range Guide

## AMG Line

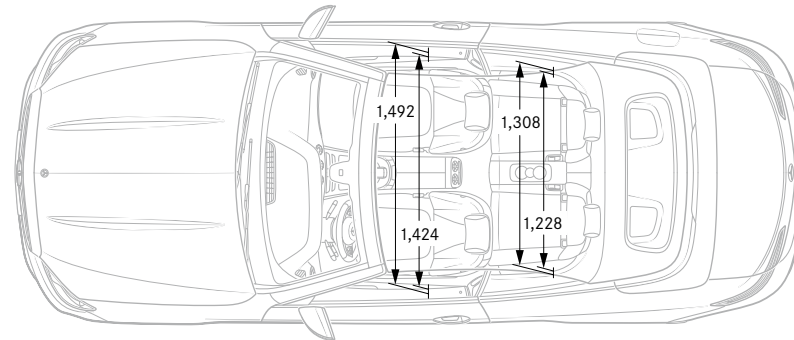
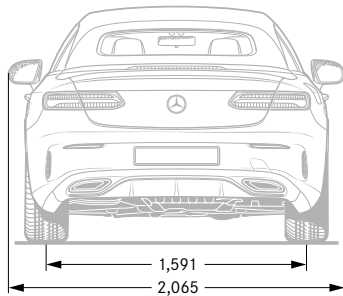
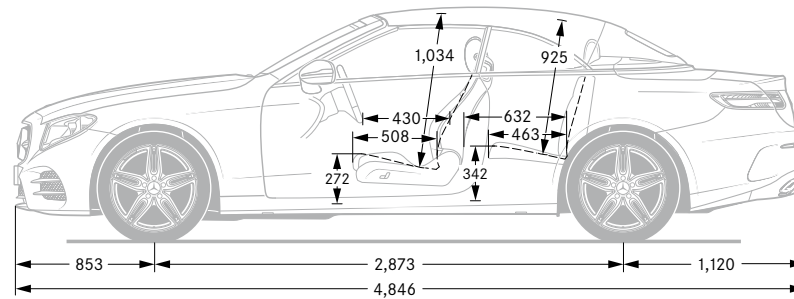
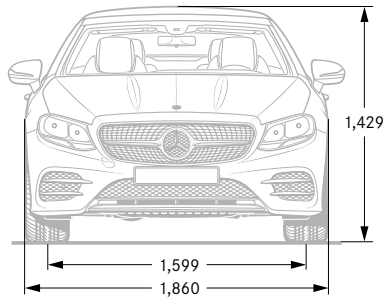



View offers > Coupé  
> Cabriolet



Book a test drive > Coupé  
> Cabriolet  
> AMG



> Find a Retailer



> View the Range Guide

## Mercedes-AMG E 53 4MATIC+

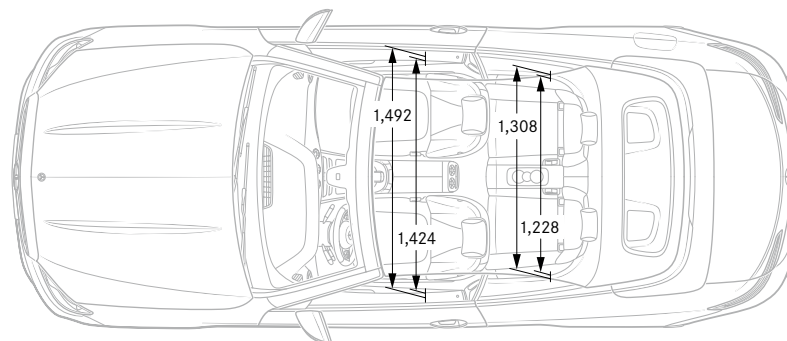
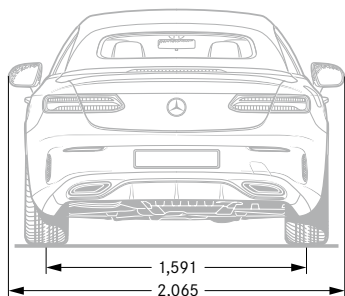
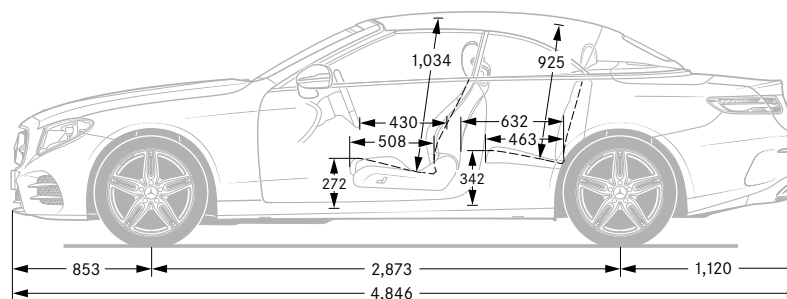
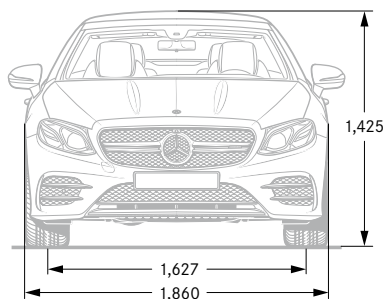

## Road Fund Licence



All road vehicle registrations are subject to Vehicle Excise Duty (Road Fund Licence), which varies in accordance with the vehicle's CO<sub>2</sub> emissions. A first year rate for each taxation band will apply. The table below shows the bands (A–M) created by the DVLA and the corresponding Road Fund Licence. CO<sub>2</sub> emissions are listed in the technical data on pages 48 and 53, and the relevant Excise Duty is reflected in the on-the-road prices on pages 26–25.

Band	CO <sub>2</sub> emissions (g/km)	First year rate petrol and RDE2 diesel (£)	First year rate all other diesel (£) <sup>1</sup>	First year rate alternative fuel (£)	Standard rate (£)	Premium rate (£) <sup>2</sup>
A	0	0.00	0.00	0.00	0.00	320.00
B	1 to 50	10.00	25.00	0.00	145.00	465.00
C	51 to 75	25.00	110.00	15.00	145.00	465.00
D	76 to 90	110.00	130.00	100.00	145.00	465.00
E	91 to 100	130.00	150.00	120.00	145.00	465.00
F	101 to 110	150.00	170.00	140.00	145.00	465.00
G	111 to 130	170.00	210.00	160.00	145.00	465.00
H	131 to 150	210.00	530.00	200.00	145.00	465.00
I	151 to 170	530.00	855.00	520.00	145.00	465.00
J	171 to 190	855.00	1,280.00	845.00	145.00	465.00
K	191 to 225	1,280.00	1,815.00	1,270.00	145.00	465.00
L	226 to 255	1,815.00	2,135.00	1,805.00	145.00	465.00
M	over 255	2,135.00	2,135.00	2,125.00	145.00	465.00

<sup>1</sup>Applies to all Mercedes-Benz diesel models which do not comply with Real Driving Emissions step 2 (RDE2)

<sup>2</sup>Premium rate only applicable to vehicles where the list price is over £40,000 including any factory-fitted options, standard UK delivery charge, number plates, fuel and VAT





View offers > Coupé  
> Cabriolet



Book a test drive > Coupé  
> Cabriolet  
> AMG



> Find a Retailer



> View the Range Guide

# Services and insurance

## Mercedes-Benz ServiceCare

We believe that servicing costs should be as flexible and affordable as possible for your E-Class, which is why we offer ServiceCare, an easy way to budget for all your servicing costs. It spreads your bills into manageable payments based on whether you have a new or used Mercedes-Benz.

With ServiceCare we guarantee the price of parts and labour for up to four services and safeguard against any further inflation. It also covers the cost of all recommended service items including brake fluid, spark plugs, air filters, fuel filters and screen wash.

You can choose either to add your servicing costs into your monthly spend or pay the full amount in a one-off payment, giving you peace of mind that they are taken care of for the period of the plan.

To receive a personalised ServiceCare plan recommendation visit the ServiceCare Calculator at [servicecarerates.mercedes-benz.co.uk](http://servicecarerates.mercedes-benz.co.uk)

## Warranty and breakdown cover

Every Mercedes-Benz comes with a three-year unlimited mileage warranty against manufacturing or material defects<sup>1</sup> and up to 30 years warranty against perforation due to corrosion from the inside out.<sup>2</sup> What's more, it's also covered by Mercedes-Benz Roadside Assistance – a unique package comprising up to 30 years pan-European breakdown assistance.<sup>2</sup>

## Motor Insurance

Superb cover comes as standard. When reviewed by an independent research company, Defaqto, Mercedes-Benz Motor Insurance received a five-star rating, the highest rating available. We design our Motor Insurance specifically for Mercedes-Benz drivers.

For more information or to obtain a quote, click **here**.

<sup>1</sup>Applies to vehicles sold by Mercedes-Benz in the UK to its franchised Retailers <sup>2</sup>Subject to full Terms and Conditions, dependent on date of registration, available upon request Mercedes-Benz Motor Insurance is underwritten by Aviva Insurance UK Limited. Credit provided, subject to status, by Mercedes-Benz Financial Services UK Ltd, MK15 8BA \*For joint protection, calls may be recorded and/or monitored. All calls charged at local rate. We may decline to quote in some circumstances



# Mercedes-Benz Finance

## Why should you finance with Mercedes-Benz?

At Mercedes-Benz we believe a great driving experience should be matched by an equally great ownership experience. That is why we put just as much thought, time and effort into designing our finance options, our service plans and our insurance cover as we do into our vehicles.

We are not in the business of simply providing a loan to fund the purchase of your dream vehicle. We look on it as a journey that we take with you, from the moment you choose your new Mercedes-Benz, to helping you in choosing your next one.

If you would like to find out more about any of our current offers, simply call into your local Mercedes-Benz Retailer where one of our Business Managers will be more than happy to talk you through anything you need to know.

## Helping you find the right solution.

You should find our finance packages are more convenient than a traditional personal loan because:

- Funds are immediately available – no waiting for cheques or loans to clear.
- There is no security required – either against your home or other assets.
- We have clear and transparent rates – the APR we quote is the APR you get.
- We have friendly Business Managers – experts in vehicle finance who can talk you through all of your plans in detail.

One of our most popular finance products is Mercedes-Benz Agility (our Personal Contract Purchase product). We also offer Contract Hire, Operating Lease and Hire Purchase solutions. If you would like to find out more about these speak to your Retailer or visit [www.mercedes-benz.co.uk/fandi](http://www.mercedes-benz.co.uk/fandi).

## Mercedes-Benz Agility (our PCP product).

At the start of an Agility agreement, you put down a deposit and decide the term of your agreement and your annual mileage. You will be advised of the Guaranteed Future Value, which offers you the reassurance of knowing exactly what you will need to pay to own the vehicle outright in the future (this is known as the Optional Purchase Payment).

Throughout your agreement you simply pay your agreed monthly payments and when the agreement comes to an end you either purchase, hand back or part-exchange your vehicle.





View offers > Coupé  
> Cabriolet



Book a test drive > Coupé  
> Cabriolet  
> AMG



> Find a Retailer



> View the Range Guide

## Agility features:

- Fixed regular payments mean you can easily budget.
- Payments are based only on a proportion of the vehicle's value, keeping your monthly payments lower.
- Our Guaranteed Future Value avoids the risk of unplanned depreciation of your vehicle.
- You defer your ownership decision until the end of the agreement.

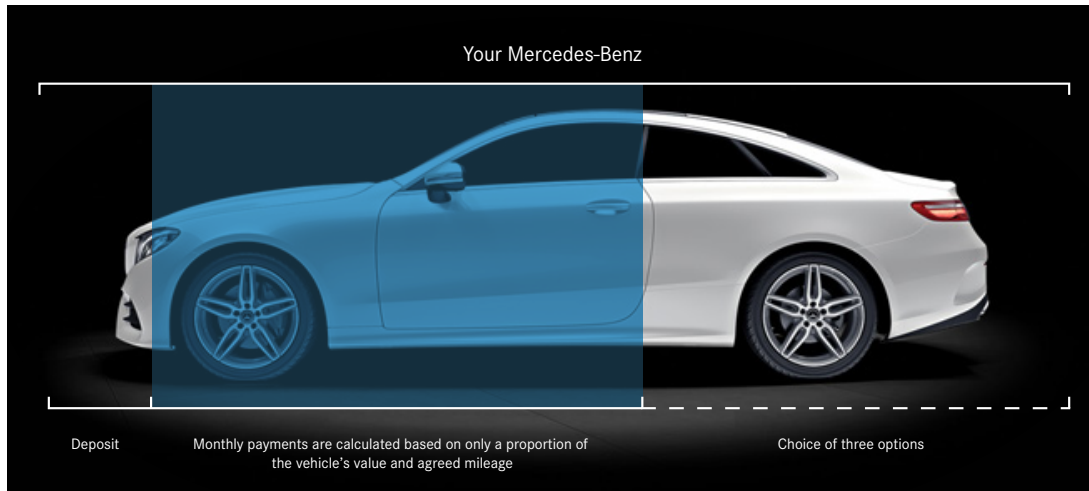

## At the end of your agreement you have three options to choose from.

### Option 1: Purchase your Mercedes-Benz.

Purchase your Mercedes-Benz by paying the Optional Purchase Payment and Purchase Activation Fee.<sup>1</sup> This will complete the purchase of your Mercedes-Benz, leaving you free to simply enjoy your vehicle.

### Option 2: Hand back your Mercedes-Benz.

If you decide to return your vehicle to us, it must be in line with our Vehicle Return Standards,<sup>\*</sup> as vehicle condition, excess mileage and other charges may be payable.

### Option 3: Part-Exchange for a new vehicle.

Purchase your Mercedes-Benz by paying the Optional Purchase Payment and Purchase Activation Fee.<sup>1</sup> This will complete the purchase of your Mercedes-Benz, leaving you free to part-exchange for a new vehicle.

<sup>1</sup>Please note the 'Purchase Activation Fee' of £10 will be debited from your account \*To find out more information about our Vehicle Return Standards please visit <http://mercedes-benz.co.uk/vrs>

 View offers [> Coupé](#)  
[> Cabriolet](#)

 Book a test drive [> Coupé](#)  
[> Cabriolet](#)  
[> AMG](#)

 [> Find a Retailer](#)

 [> View the Range Guide](#)

Follow us on the following social media channels:

 [facebook.com/mercedesbenzuk](https://facebook.com/mercedesbenzuk)

 [twitter.com/mercedesbenzuk](https://twitter.com/mercedesbenzuk)

 [youtube.com/mercedesbenzuk](https://youtube.com/mercedesbenzuk)

 [instagram.com/mercedesbenzuk](https://instagram.com/mercedesbenzuk)

Effective from December 2019 Production. Information correct at time of publication.

Prices and specifications are subject to change without prior notice.

MBC238PL/1119 MY800.5

Mercedes-Benz Cars UK Limited, Tongwell, Milton Keynes, MK15 8BA. Company number 2448457 [www.mercedes-benz.co.uk](http://www.mercedes-benz.co.uk)