

# The Sharan

## Price and specification guide

Effective from 1.4.2020



[Configure now >](#)



# The Sharan. At home wherever you are.

As you'd expect, the Sharan is stylish, spacious and practical. Flexible easy folding seats, convenient sliding doors and contemporary upholsteries provide an elegant interior, with seats as comfortable as your favourite sofa. And, with high quality materials and a wealth of refinements enhancing the driving experience like never before, this is home comfort on a whole new level.



Model shown is Sharan SEL with optional 18" 'Marseille' alloy wheels, Xenon dipped beam headlights and metallic paint.  
Front cover model shown is Sharan SEL with optional 18" 'Marseille' alloy wheels, Xenon dipped beam headlights and metallic paint.

# Space to live life as you choose.

The Sharan provides enough room to comfortably accommodate up to seven occupants, as well as luggage, in style. A choice of cloth or leather\* upholstery in contemporary colours allows you to create the interior of your taste, while the seats configure easily to suit your needs. Depending on whether you're travelling alone or with family, the rear seats fold down to create from 300 up to 2,297 litres† of loading space – with so much space at your disposal, your options are countless.



**01** The **three rows of seats** are as comfortable as they look and every bit as luxurious, thanks to the choice of stylish upholstery. If you want to create an illusion of more space, you can always extend upwards with the electrically operated **panoramic sliding sunroof** allowing the view and fresh air to flood in. Standard on SEL and optional on all other models.

**02** The exterior includes eye-catching **rear light clusters**, adding a touch of elegance to the exterior of the Sharan. Image shown features optional 18 inch 'Marseille' alloy wheels and metallic paint.

\* Some parts of leather interior will contain artificial leather.  
 † Please [click here](#) for full details of dimensions.

# Model prices.

Cars registered on or after 1.4.2020.

		RDE2 Compliant	Fuel	Transmission	Output, PS	CO <sub>2</sub> emission, g/km <sup>1</sup> WLTP test cycle	Basic Recommended Retail £	VAT £	Total Recommended Retail £	Additional 'On the road' Costs £ <sup>2</sup>	Manufacturer's Recommended 'On the road' Retail £ <sup>2</sup>	P.11D Value £ <sup>3</sup>	BIK % <sup>4</sup>	ABI Insurance Group <sup>5</sup>
<b>5-DOOR MPV RANGE – 7 SEATS.</b>														
S <sup>††</sup>	1.4 ltr TSI <sup>††</sup>	No	Petrol	6-spd manual	150	176	24,395.83	4,879.17	29,275.00	1,560.00	30,835.00	29,910.00	37	19E
	2.0 ltr TDI SCR <sup>††</sup>	No	Diesel	6-spd manual	150	166	26,537.50	5,307.50	31,845.00	1,560.00	33,405.00	32,480.00	37	19E
	2.0 ltr TDI SCR <sup>††</sup>	No	Diesel	6-spd auto DSG	150	176	27,720.83	5,544.17	33,265.00	1,995.00	35,260.00	33,900.00	37	19E
SE NAV <sup>‡</sup>	1.4 ltr TSI <sup>‡</sup>	No	Petrol	6-spd manual	150	172	26,858.33	5,371.67	32,230.00	1,560.00	33,790.00	32,865.00	37	20E
	1.4 ltr TSI <sup>‡</sup>	No	Petrol	6-spd auto DSG	150	186	27,995.83	5,599.17	33,595.00	1,560.00	35,155.00	34,230.00	37	20E
	2.0 ltr TDI SCR <sup>‡</sup>	No	Diesel	6-spd manual	150	169	28,741.67	5,748.33	34,490.00	1,560.00	36,050.00	35,125.00	37	20E
	2.0 ltr TDI SCR <sup>‡</sup>	No	Diesel	6-spd auto DSG	150	179	29,866.67	5,973.33	35,840.00	1,995.00	37,835.00	36,475.00	37	20E
	2.0 ltr TDI SCR <sup>‡</sup>	No	Diesel	6-spd auto DSG	177	182	31,066.67	6,213.33	37,280.00	1,995.00	39,275.00	37,915.00	37	23E
SEL <sup>‡</sup>	2.0 ltr TDI SCR <sup>‡</sup>	No	Diesel	6-spd manual	150	170	30,625.00	6,125.00	36,750.00	1,560.00	38,310.00	37,385.00	37	18E
	2.0 ltr TDI SCR <sup>‡</sup>	No	Diesel	6-spd auto DSG	150	180	31,858.33	6,371.67	38,230.00	1,995.00	40,225.00	38,865.00	37	18E
	2.0 ltr TDI SCR <sup>‡</sup>	No	Diesel	6-spd auto DSG	177	182	33,045.83	6,609.17	39,655.00	1,995.00	41,650.00	40,290.00	37	21E

1 Figures shown are for comparability purposes; only compare fuel consumption and CO<sub>2</sub> figures with other vehicles tested to the same technical procedures. These figures may not reflect real life driving results, which will depend upon a number of factors including the accessories fitted (post-registration), variations in weather, driving styles and vehicle load. Data correct at 1.4.2020. For more information, please see [www.volkswagen.co.uk/need-help/wltp](http://www.volkswagen.co.uk/need-help/wltp) or consult your authorised Volkswagen retailer. 2 The recommended 'On the road' prices and any VED charges quoted reflect the VED charges which apply to vehicles registered after 1 April 2020. The price and charges you pay may differ from any prices or charges displayed or quoted before 1 April 2020. For full details of 'First year rate' VED (Vehicle Excise Duty), delivery to retailer, number plates and vehicle first registration fee included in the recommended 'On the road' retail price, [please click here](#). 3 P11D value = Total recommended retail price + delivery to retailer £509.17, + number plates £20, + VAT £105.83 (calculated by reference to total of delivery to retailer + number plates). P11D value is based on standard specification model with no factory-fitted options or other accessories. 4 The BIK charges quoted reflect the charges which apply to vehicles registered after 6 April 2020. These charges may differ from any charges displayed or quoted before 6 April 2020. The BIK % figure quoted includes the 4% diesel supplement, where applicable. Please consult your Volkswagen retailer for full details. 5 The ABI insurance group is the recommended insurance rating set by the Association of British Insurers. Please note that insurance group ratings are purely advisory. They are used by insurers (ABI members and Lloyd's syndicates) as one of the factors in calculating premiums. Insurers are not required to follow the advisory group ratings and they may depart from them if they so wish.

‡ These vehicles are WLTP (Worldwide Harmonised Light-Duty Vehicles Test Procedure) type approved vehicles. More information is available at [www.volkswagen.co.uk/need-help/wltp](http://www.volkswagen.co.uk/need-help/wltp).

† Please note these models may no longer be available to order, or only available from stock and not available to factory order.

SCR (Selective Catalytic Reduction) requires AdBlue®, [please click here](#) or visit [www.volkswagen.co.uk/technology/engines/adblue/technology/engines/adblue](http://www.volkswagen.co.uk/technology/engines/adblue/technology/engines/adblue) for more details.

RDE2 refers to Real Driving Emissions Step 2.

## Volkswagen Service Plan – Retail sales only.

For vehicles under 1 year old set to the Fixed Service regime that has not had its first service, comprising first two manufacturer's scheduled services:

- 'Oil service' including oil filter change
- 'Oil service' including oil filter change and 'Inspection service' plus a pollen filter replacement (if required)

Excludes electric vehicles. Service plan covers first two consecutive services, limited to 1x 'Oil service' and 1x 'Oil and Inspection service'. T&Cs apply: All vehicles must be set to the Fixed Service regime by the retailer. Maximum age of car is 12 months (Service plan must be taken out before first service is due). Additional work, including wear and tear is excluded. Servicing must be carried out in line with the requirement of the Service Schedule. All work must be carried out by an Authorised Volkswagen Repairer. Offers may be varied or withdrawn at any time. Plan validity is dependent on required payments received. Administered by Volkswagen Financial Services. Retail sales only. For pricing and further details, please consult your authorised Volkswagen retailer or visit [www.volkswagen.co.uk](http://www.volkswagen.co.uk)

*Prices, specifications, features, technical and other information (including fuel consumption, CO<sub>2</sub> emissions and range) are updated regularly and are subject to change without notice (this may include changes between order and delivery). There may be a delay in updates to our materials – always consult your authorised Volkswagen retailer for the latest information.*

*Volkswagen UK may change RRP's at any time (this includes where there are government changes in regulation and/or legislation).*

*There may be a delay to any RRP displaying correctly on our materials. Always obtain prices from your chosen authorised Volkswagen retailer.*

VAT IS CALCULATED AT 20%. EFFECTIVE FROM 1 APRIL 2020.

# Standard items of equipment: S†.

## VOLKSWAGEN SERVICE

- 3-year/60,000 miles warranty (whichever is soonest)
- 3-year paintwork warranty
- 12-year body protection warranty
- Volkswagen Roadside Assistance
- Exclusions and terms apply, [please click here](#) for more details

## WHEELS AND SUSPENSION

- 6½J x 16" steel wheels with 205/60 R16 self-sealing tyres
- Full size wheel trims
- Tyre mobility kit including compressor and sealing foam

## EXTERIOR

- Black radiator grille with chrome trimmed radiator grille louvres
- Body-coloured bumpers, front and rear
- Body-coloured door handles
- Body-coloured door mirrors with integrated indicators incorporating LED technology
- Halogen clear headlights, range adjustable with daytime running lights
- Rear screen wash/wipe with intermittent wipe
- Sliding rear doors
- Windscreen wiper with intermittent wipe and 4 position delay

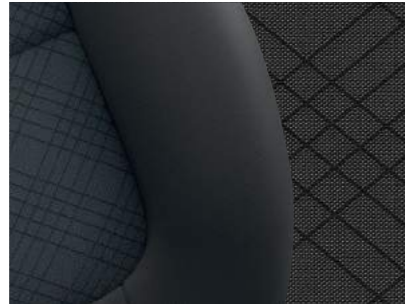

## INTERIOR

- Coat hooks x 2, rear
- Cup holders, front x 2
- Front centre armrest with storage compartment
- Glovebox, cooled, illuminated and lockable
- Interior light delay
- Leather trimmed three-spoke multifunction steering wheel and gear knob
- LED reading lights, front x 2, rear x 2
- Load lashing points in luggage compartment, chrome-plated and folding x 2, rigid x 2
- Luggage compartment cover, retractable and removable
- 'Matt Chrome' decorative inserts in dash, centre console and front doors
- Seating
  - Upholstery - 'Campus' cloth
  - Driver's and front passenger's seat height adjustment
  - Easy folding seating system, 2nd and 3rd row seats
  - Floor storage compartment in footwell, 2nd row, outer seats
  - 3 single seats in 2nd row, foldable
  - 2 single seats in 3rd row, foldable
- Storage area, dash centre
- Storage compartment in rear doors (for 1 litre bottle)
- Storage compartment in roof console
- Sun visors

## SAFETY AND SECURITY

- ABS (Anti-lock Braking System) with HBA (Hydraulic Brake Assist)
- Airbags
  - Curtain airbag system, front and rear passengers
  - Driver's and front passenger's airbags with passenger's airbag deactivation switch
  - Driver's knee airbag
  - Front seat side impact airbags
- Alarm with interior protection
- Automatic coming/leaving home lighting function
- Automatic Post-Collision Braking System
- Disc brakes, front and rear (front ventilated)
- Driver's and front passenger's safety-optimised head restraints
- Electronic child locks for rear doors and rear electric windows
- Electronic engine immobiliser
- ESC (Electronic Stability Control) including EDL (Electronic Differential Lock) and ASR (Traction Control)
- High level 3rd brake light
- Isofix child seat preparation (for 3 child seats in 2nd row seats)<sup>1</sup>
- Reflectors in front doors
- Remote central locking with 2 remote folding keys
- Seat belts - front seats, three-point with tensioners, height-adjustable
- Seat belts - 2nd row seats, outer and centre seats, three-point
- Tyre pressure loss indicator
- Warning buzzer and light for front seat belts if unfastened
- 5 rear head restraints

## DRIVER'S ASSISTANCE

- Battery regeneration (recuperation - energy recovery during braking)
- Dusk sensor, automatic driving lights
- Electronic parking brake - with auto hold function
- Front Assist with City emergency braking system and speed limiter
- Lane Assist, camera controlled warning system should your vehicle drift out of its lane
- Multifunction computer, includes visual gear change recommendation for improved fuel consumption
- Power-assisted steering, speed-sensitive
- Rear Traffic Alert, vehicle monitoring during reversing manoeuvres with alerts via an audible and visual warning, or brake intervention where a collision is imminent
- Side scan, radar sensor controlled warning system for lane changing and blind spots with visual warning via light in door mirror housing
- Start/Stop function

## COMFORT AND CONVENIENCE

- Climate control - 3Zone electronic air conditioning with automatic air recirculation
- Electric windows, front and rear
- Electrically heated and adjustable door mirrors
- Rain sensor and automatic dimming interior rear-view mirror

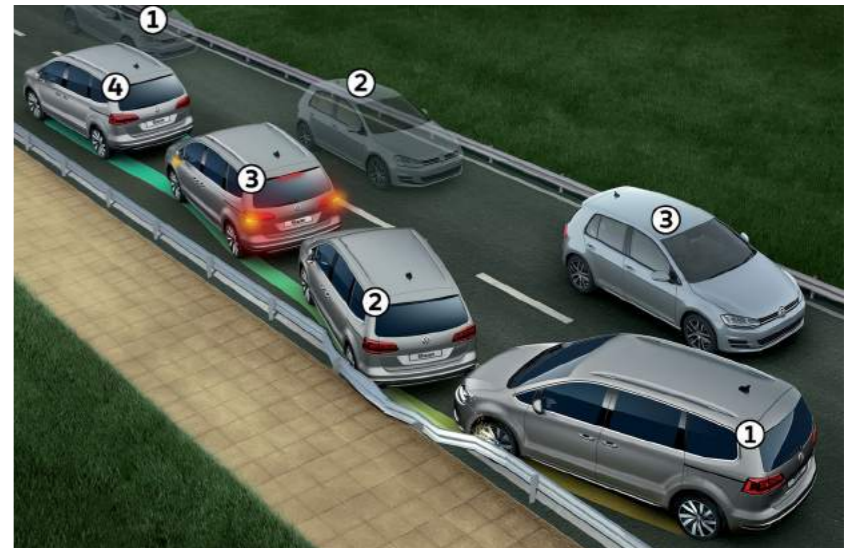

1 The integrated child seats cannot be used in conjunction with the Isofix child seats.  
 2 Devices must be Bluetooth HFP (Hands Free Profile) compatible, please contact your authorised Volkswagen retailer for specific phone compatibility.  
 3 Speed Limit Display only reflects national speed limits and does not show temporary speed limit restrictions, or where permanent changes to speed limits are made in-between map updates.  
 4 Only operable in conjunction with compatible tablets and smartphones including iPhone 5 and above. Please see [www.volkswagen.co.uk](http://www.volkswagen.co.uk) to check smartphone compatibility.  
 5 Car-Net 'Guide and Inform' services are accessed via a compatible mobile device. Please see [www.volkswagen.co.uk](http://www.volkswagen.co.uk) for more information. The use of 'Guide and Inform' services entails exchanging large volumes of data. As such, we strongly recommend that you sign-up for a flat rate data plan with your mobile network provider. After the initial 3-year Car-Net contract, an annual subscription is chargeable for the continuation of 'Guide and Inform' services.  
 † Please note these models may no longer be available to order, or only available from stock and not available to factory order.

The specifications listed are for information purposes only as our products are continually updated and changes may be made to the specifications at any time. If you require any specific feature, please consult your authorised Volkswagen retailer who is regularly updated with any change in specification. Specifications are subject to change without notice.

# Standard items of equipment: S† (continued).

## IN-CAR ENTERTAINMENT AND COMMUNICATIONS

Discover Navigation infotainment system

- 8.0" colour touch-screen
- Bluetooth telephone and audio connection for compatible devices<sup>2</sup>
- Branded points of interest
- DAB digital radio receiver
- Dynamic navigation based on TMC+, three route options (Fast, Short, Eco)
- Dynamic traffic sign recognition
- MDI (Multi Device Interface), via USB connection - compatible products only
- Music playback from MP3, WMA and AAC files
- Preloaded European navigation data
- SD card reader
- Simultaneous pairing of 2 compatible mobile devices
- Single CD player
- SMS functionality - read, compose and send SMS messages using touch-screen display (when stationary, compatible Android smartphones only)
- Speed Limit Display<sup>3</sup>
- Title and cover art display
- Volkswagen Media Control<sup>4</sup> - allows remote control of the infotainment system via smartphone or tablet
- 2D/3D map view
- 4 x 20 watt output
- 8 speakers, front and rear

Premium USB cable (choice of either Apple or Android smartphone compatibility)

USB connection, front, USB charging socket rear

## CAR-NET

Car-Net 'Guide and Inform' - 3-year subscription

- Providing online access to a range of useful information such as traffic, fuel pricing, weather and news feeds<sup>5</sup>

## WE CONNECT GO®

DataPlug sends vehicle information via Bluetooth to the We Connect Go® app displayed on your smartphone. We Connect Go® app free to download from the App Store or Google Play Store, with DataPlug connection to OBD2 port underneath the steering wheel. Features include:

- My Volkswagen - vehicle information for service and maintenance intervals, warning message displays, fuel level and mileage
- Trips - business or private journey analysis. Provides detailed map views, journey details, statistics and journey cost
- Driving style - analysis of driving style to provide tips for more efficient driving
- Parking space - displays parking location and parking duration
- Fuel monitor - monitors fuel consumption and cost
- Service partner - locates and provides directions to local retailers. Direct dial access if required
- Assistance call - direct dial to Volkswagen's 24-hour Customer Service helpline with the ability to send the vehicle's location
- Challenges - sets efficiency and driving style targets. Collect points and trophies with bonus challenges to improve your scores



1 The integrated child seats cannot be used in conjunction with the Isofix child seats.

2 Devices must be Bluetooth HFP (Hands Free Profile) compatible, please contact your authorised Volkswagen retailer for specific phone compatibility.

3 Speed Limit Display only reflects national speed limits and does not show temporary speed limit restrictions, or where permanent changes to speed limits are made in-between map updates.

4 Only operable in conjunction with compatible tablets and smartphones including iPhone 5 and above. Please see [www.volkswagen.co.uk](http://www.volkswagen.co.uk) to check smartphone compatibility.

5 Car-Net 'Guide and Inform' services are accessed via a compatible mobile device. Please see [www.volkswagen.co.uk](http://www.volkswagen.co.uk) for more information. The use of 'Guide and Inform' services entails exchanging large volumes of data. As such, we strongly recommend that you sign-up for a flat rate data plan with your mobile network provider. After the initial 3-year Car-Net contract, an annual subscription is chargeable for the continuation of 'Guide and Inform' services.

† Please note these models may no longer be available to order, or only available from stock and not available to factory order.

The specifications listed are for information purposes only as our products are continually updated and changes may be made to the specifications at any time. If you require any specific feature, please consult your authorised Volkswagen retailer who is regularly updated with any change in specification. Specifications are subject to change without notice.

## Additional items of standard equipment: SE Nav (over S).



**WHEELS AND SUSPENSION**  
 Alloy wheels, four 6½J x 16" 'Memphis' with 215/60 R16 super low rolling resistance tyres and anti-theft wheel bolts

**EXTERIOR**  
 Chrome side window surrounds  
 Chrome trimmed front air intake grille surround  
 'Gloss Black' radiator grille with chrome trimmed radiator grille louvres  
 Rear tinted glass from B-pillar backwards, approx. 65% tinted  
 Roof rails, chrome-plated

**INTERIOR (CONTINUED)**  
 Carpet mats, front, 2nd and 3rd row  
 Cup holders, front x 2 with cover  
 Seating  
 - Upholstery - 'Stripes' cloth  
 - Driver's and front passenger's under seat drawer  
 - Driver's seat with electrically adjustable backrest and lumbar support  
 - Front comfort seats  
 - Folding tables on rear of front seats  
 - Front passenger's seat with height and lumbar adjustment  
 - Front seat back storage pockets  
 LED reading lights, front x 2, rear x 2  
 Steering wheel including paddle shift (auto DSG only)  
 Storage area with lid, dash centre  
 'Triangle titan' decorative inserts in dash, centre console and front doors  
 Vanity Mirrors, illuminated

**SAFETY AND SECURITY**  
 Driver's and front passenger's four way adjustable head restraints  
 XDS electronic differential lock for improved traction and handling (2.0 TDI 177 PS and 2.0 TDI 184 PS only)

**DRIVER'S ASSISTANCE**  
 Adaptive Cruise Control (ACC), including Front Assist, radar sensor controlled distance monitoring system, City emergency braking system, cruise control and speed limiter  
 Cruise control  
 Driver Alert system  
 Parking sensors, front and rear



## Additional items of standard equipment: SEL (over SE Nav).



**WHEELS AND SUSPENSION**  
 Alloy wheels, four 7J x 17" 'Sydney' with 225/50 R17 self-sealing tyres and anti-theft wheel bolt

**EXTERIOR**  
 Front fog lights with static cornering function  
 Panoramic sunroof

**INTERIOR**  
 Coat hanger  
 Footwell illumination in front and 2nd row  
 Seating  
 - Upholstery - Alcantara seat centre section with 'Vienna' leather\* side bolsters  
 - Front sport seats  
 - Heated front seats  
 'Titanium Silver' look decorative inserts in dash, centre console and front doors

**SAFETY AND SECURITY**  
 Entry/warning lights in all doors  
 XDS electronic differential lock for improved traction and handling (2.0 TDI 177 PS and 2.0 TDI 184 PS only)

**COMFORT AND CONVENIENCE**  
 Heated windscreen washer jets



\* Some parts of leather interior will contain artificial leather

The specifications listed are for information purposes only as our products are continually updated and changes may be made to the specifications at any time. If you require any specific feature, please consult your authorised Volkswagen retailer who is regularly updated with any change in specification. Specifications are subject to change without notice. Model shown features optional metallic paint.

# Multimedia.

The Sharan's intuitive touch-screen displays and state-of-the-art technology now feature Car-Net 'App-Connect' which enables you to display and operate certified smartphone apps via USB connection on the infotainment system, enhancing your driving experience still further. Car-Net 'App-Connect' is optional on all models.



**01** Optional **Car-Net 'App-Connect'**<sup>1</sup> combines three innovative technologies that allow you to bring compatible smartphone apps onto your infotainment system's touch-screen: the established 'MirrorLink'<sup>™</sup> apps, the 'CarPlay' function from Apple, and the 'Android Auto' function from Google. As such, Volkswagen were the first manufacturer to offer a choice of three interfaces to connect your smartphone. This means you no longer have to be without the practical assistance of your smartphone even when you're behind the wheel – simply connect your compatible smartphone to your car via USB connection and the system will allow display and operation of certified apps while driving, including audio and voice control – if supported by the app. Volkswagen apps such as 'Think Blue. Trainer', 'Shared Audio', 'Drive & Track' or 'My Guide' can help make your journey more pleasant and interesting, providing useful tips about handling your car, parking opportunities and even where to find the nearest café. Optional on all models.

<sup>1</sup> Only operable in conjunction with compatible smartphones including iPhone 5 and above. Display and operation of certified apps including audio and voice control (if supported by the app). Usage of certified apps only while driving. Please see [www.volkswagen.co.uk](http://www.volkswagen.co.uk) to check smartphone compatibility.





01

02 With the **two USB charging sockets** on the rear centre console, and an extra one in the front, you can easily charge your mobile devices while you're on the move. Standard on SE Nav models and above.



02

01 The Discover Navigation touch-screen navigation/infotainment system with Car Net 'Guide and Inform'<sup>1</sup> and 8.0 inch colour touch-screen display provides navigational functionality, dynamic navigation based on TMC+, branded points of interest, preloaded European navigation data, dynamic traffic sign recognition, Speed Limit Display<sup>2</sup> and three routes (Fast, Short and Eco), 2D/3D map view and Volkswagen Media Control<sup>3</sup> which allows remote control of the infotainment system via smartphone or tablet. It comes with 3-years' Car Net 'Guide and Inform', providing online access to such information as traffic, fuel pricing, weather and news feeds; and includes online navigation software updates enabling you to download the latest map data. The infotainment system also includes a DAB digital radio receiver, single CD player, MDI (Multi Device Interface) via USB connection – compatible products only, music playback from MP3, WMA and AAC files, title and cover art display and SD card reader. Connection for Bluetooth telephone and audio compatible devices<sup>4</sup> are available, along with simultaneous pairing of two compatible mobile devices and SMS functionality – allowing you to read, compose and send SMS messages using the touch-screen display when the vehicle is stationary (compatible Android smartphones only). Standard on all models.

1 Car-Net 'Guide and Inform' services are accessed via a compatible mobile device. Please see [www.volkswagen.co.uk](http://www.volkswagen.co.uk) for more information. The use of 'Guide and Inform' services entails exchanging large volumes of data. As such, we strongly recommend that you sign-up for a flat rate data plan with your mobile network provider. After the initial 3-year Car-Net contract, an annual subscription is chargeable for the continuation of Car-Net 'Guide and Inform' services.

2 Speed Limit Display only reflects national speed limits and does not show temporary speed limit restrictions, or where permanent changes to speed limits are made in-between map updates.

3 Only operable in conjunction with compatible tablets and smartphones including iPhone 5 and above. Please see [www.volkswagen.co.uk](http://www.volkswagen.co.uk) to check smartphone compatibility.

4 Devices must be Bluetooth HFP (Hands Free Profile) compatible, please contact your authorised Volkswagen retailer for specific phone compatibility.

# Driver's assistance systems

The Sharan is equipped with a wealth of technological refinements, designed to increase comfort and provide driver assistance on every journey.



01

**01 The rear-view camera** helps you to reverse park, giving you a clear view to the rear of your vehicle via the vehicle's infotainment system display. Thanks to the high resolution detail, even small obstacles such as kerbs can be clearly recognised and avoided. Optional on all models.



02



03

**02 Front Assist with City emergency braking system and speed limiter** cleverly monitors the traffic situation in front of your car, warning you when you get too close to a vehicle and even boosts brake pressure to help to try and avoid a collision. Standard on all models.

**03 Side scan including blind spot monitor** makes motorway driving safer by helping to prevent accidents when you want to change lanes. The radar system monitors the areas to the left and right of the car and up to 50 metres behind it, and should it detect a potentially hazardous situation, it warns you by means of flashing warning lights in the door mirror housing. Standard on all models.

[Configure now >](#)



**01 The 'Park Assist' system** not only makes parallel parking easier, but also helps you reverse park into a space at 90 degrees to the kerb. Using ultrasonic parking sensors, Park Assist will detect a parking space large enough for either bay or parallel parking. Once the vehicle is in reverse, all the driver has to do is operate the accelerator and brake, and keep a lookout, while the Sharan steers itself into its chosen space. Optional on SE Nav and SEL models. Optional Park Assist which also includes front and rear parking sensors is available on S models.

**02 The Automatic Post-Collision Braking System.** Supported by the airbag sensors, the Automatic Post-Collision Braking System automatically initiates braking after the vehicle suffers a collision. The system brakes for as long as necessary to reduce the speed of the vehicle to around 6mph in order to prevent or help minimise the severity of subsequent collisions. Standard on all models.

**03 Adaptive Cruise Control (ACC),** including Front Assist radar sensor controlled distance monitoring system, City emergency braking system, cruise control and speed limiter offers you intelligent control of your driving speed by automatically adjusting acceleration and braking. Whether around town or on the motorway, the system will adjust your speed to that of the vehicle in front, keep your specified distance, warn if you are approaching too fast and, in an emergency situation, generate enough braking force to help reduce the severity of a collision or even possibly prevent the collision entirely. Standard on SE Nav and SEL models.

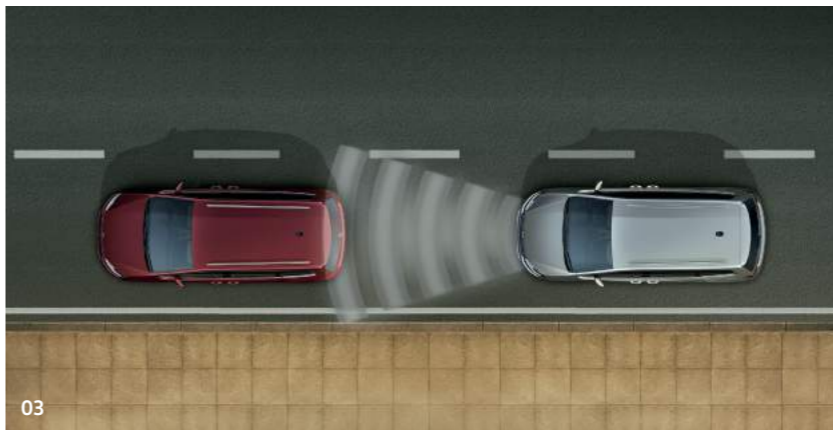
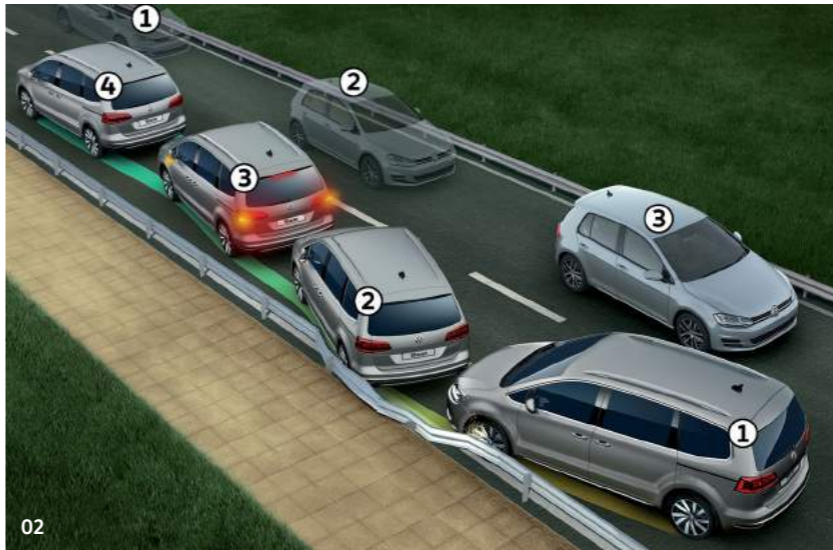
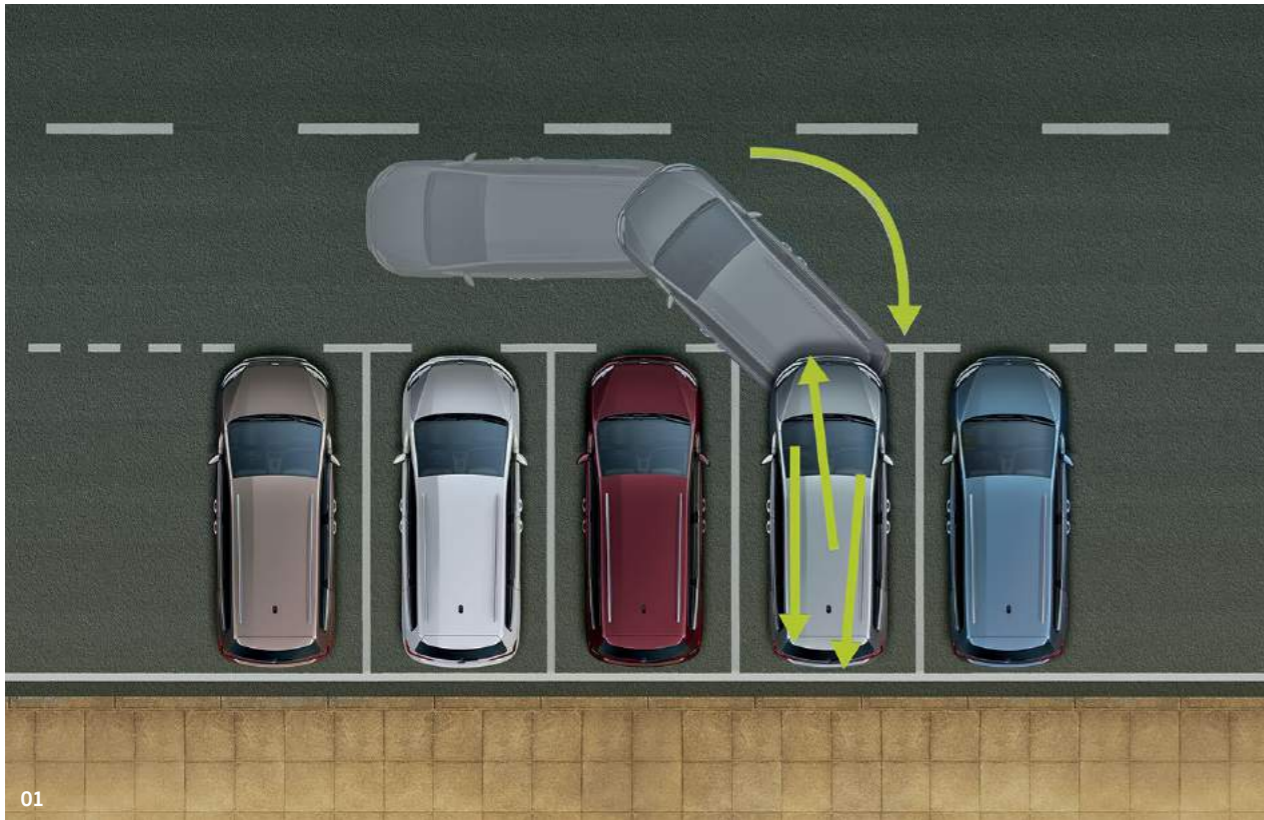

Images shown are for illustration purposes only and may not necessarily reflect UK specification.

# Factory-fitted options.

## WHEELS AND SUSPENSION

		S	SE Nav	SEL	Basic RRP £ Excluding VAT	Total RRP £ Including VAT
16" 'Memphis'	Four 6½J x 16" 'Memphis' with 215/60 R16 super low rolling resistance tyres and anti-theft wheel bolts	<input type="radio"/>	<input checked="" type="radio"/>	<input type="radio"/>	516.67	620.00
16" 'Jakarta'	Four 6½J x 16" 'Jakarta' with 215/60 R16 super low rolling resistance tyres and anti-theft wheel bolts	<input type="radio"/>	<input type="radio"/>	<input type="radio"/>	162.50	195.00
17" 'Stratford'	Four 7J x 17" 'Stratford' with 225/50 R17 tyres and anti-theft wheel bolts	<input type="radio"/>	<input type="radio"/>	<input type="radio"/>	437.50	525.00
	Four 7J x 17" 'Stratford' with 225/50 R17 tyres and anti-theft wheel bolts	<input type="radio"/>	<input type="radio"/>	<input type="radio"/>	95.83	115.00
18" 'Marseille'	Four 7½J x 18" 'Marseille' with 225/45 R18 tyres and anti-theft wheel bolts and sports suspension (lowered by approx. 15mm)	<input type="radio"/>	<input type="radio"/>	<input type="radio"/>	1,195.83	1,435.00
	Four 7½J x 18" 'Marseille' with 225/45 R18 tyres and anti-theft wheel bolts and sports suspension (lowered by approx. 15mm)	<input type="radio"/>	<input type="radio"/>	<input type="radio"/>	862.50	1,035.00
18" 'Toulon'	Four 7½J x 18" 'Toulon' with 225/45 R18 tyres and anti-theft wheel bolts and sports suspension (lowered by approx. 15mm)	<input type="radio"/>	<input type="radio"/>	<input type="radio"/>	1,195.83	1,435.00
	Four 7½J x 18" 'Toulon' with 225/45 R18 tyres and anti-theft wheel bolts and sports suspension (lowered by approx. 15mm)	<input type="radio"/>	<input type="radio"/>	<input type="radio"/>	866.67	1,040.00
Dynamic Chassis Control (DCC)	Variable suspension settings. Choice of three settings: Sport, Comfort and Normal. <i>Not with Sports suspension</i>	<input type="radio"/>	<input type="radio"/>	<input type="radio"/>	720.83	865.00
Sports suspension	Lowered by approx. 15mm. <i>Not with Dynamic Chassis Control (DCC)</i>	<input type="radio"/>	<input type="radio"/>	<input type="radio"/>	212.50	255.00

Choosing larger alloy wheels than standard, as an option, may result in increased fuel consumption as well as higher CO<sub>2</sub> emissions and subsequently increased Vehicle Excise Duty (VED) band, and BIK rates paid by company car drivers may increase. This is due to the fact that larger wheels have both more aerodynamic drag and more mechanical drag, resulting in increased rolling resistance and increased wind resistance. As a result, the VED band that the vehicle falls into may increase from its original VED band when fitted with standard size wheels. In some instances, the recommended 'On the road' retail price paid for the vehicle may increase as a result of the increased VED rate. Please refer to [CO<sub>2</sub> emissions, BIK % and VED Bands with optional wheels section](#).

## PAINT

Non-Metallic	Urano Grey	<input type="radio"/>	<input type="radio"/>	<input type="radio"/>	No cost option	
	Pure White	<input type="radio"/>	<input type="radio"/>	<input type="radio"/>	308.33	370.00
Metallic and Pearl Effect	Reflex Silver, Atlantic Blue , Dark Oak Brown, Indium Grey, Deep Black	<input type="radio"/>	<input type="radio"/>	<input type="radio"/>	562.50	675.00

Please refer to [Paint and Combinations section](#), or visit [www.volkswagen.co.uk](http://www.volkswagen.co.uk) for full availability of paint colours.

● Standard equipment ○ Optional equipment – Not available. Factory-fitted options are subject to availability and extended delivery.

Volkswagen UK may change RRP's at any time (this includes where there are government changes in regulation and/or legislation). There may be a delay to any RRP displaying correctly on our materials. Always obtain prices from your chosen authorised Volkswagen retailer.

VAT IS CALCULATED AT 20%. EFFECTIVE FROM 1 APRIL 2020.

# Factory-fitted options.

## EXTERIOR

		S	SE Nav	SEL	Basic RRP £ Excluding VAT	Total RRP £ Including VAT
Front fog lights	Including static cornering function	<input type="radio"/>	<input type="radio"/>	<input checked="" type="radio"/>	208.33	250.00
Gas discharge (Xenon) dipped beam headlights <sup>1</sup>	Including automatic range adjustment, dynamic curve lighting, LED daytime running lights, static cornering function, headlight washers and LED rear number plate lights	<input type="radio"/>	<input type="radio"/>	<input type="radio"/>	1,025.00	1,230.00
Rear tinted glass	Rear tinted glass from B-pillar backwards, approx. 65% tinted	<input type="radio"/>	<input checked="" type="radio"/>	<input checked="" type="radio"/>	200.00	240.00
Roof rails	Black	<input type="radio"/>	-	-	200.00	240.00
	Chrome-plated with load bars	-	<input type="radio"/>	<input type="radio"/>	216.67	260.00
Towbar – swivelling	Swivelling towbar with electric release. With 13-pin connection and 12 electrified poles providing vehicle lighting plus additional power supply for caravan auxiliary battery charger, internal trailer lighting and fridge	<input type="radio"/>	<input type="radio"/>	<input type="radio"/>	762.50	915.00

1 Not in conjunction with High beam assist.

## INTERIOR

Cargo management system	For luggage compartment, flexible securing system for load space separation and stowage. Suitable for light loads	<input type="radio"/>	<input type="radio"/>	<input checked="" type="radio"/>	145.83	175.00
Carpet mats	Front, 2nd and 3rd row	<input type="radio"/>	<input checked="" type="radio"/>	<input checked="" type="radio"/>	75.00	90.00
Lumbar support	Lumbar support for driver's seat	-	<input checked="" type="radio"/>	<input checked="" type="radio"/>	66.67	80.00
Net partition	Floor to roof lining	<input type="radio"/>	<input type="radio"/>	<input type="radio"/>	187.50	225.00
Upholstery – leather <sup>1</sup>	'Vienna' leather upholstery including heated front seats and heated windscreen washer jets	-	<input type="radio"/>	-	1,750.00	2,100.00
	'Vienna' leather upholstery including heated front seats and heated windscreen washer jets	-	-	<input type="radio"/>	525.00	630.00

1 Some parts of leather interior will contain artificial leather.

● Standard equipment ○ Optional equipment - Not available. Factory-fitted options are subject to availability and extended delivery.

Volkswagen UK may change RRP's at any time (this includes where there are government changes in regulation and/or legislation).  
There may be a delay to any RRP displaying correctly on our materials. Always obtain prices from your chosen authorised Volkswagen retailer.

VAT IS CALCULATED AT 20%. EFFECTIVE FROM 1 APRIL 2020.

# Factory-fitted options.

## IN-CAR ENTERTAINMENT AND COMMUNICATIONS

		S	SE Nav	SEL	Basic RRP £ Excluding VAT	Total RRP £ Including VAT
<b>Car-Net 'App-Connect'</b>	Combined functionality of Apple 'CarPlay', Google 'Android Auto' and 'MirrorLink'™ allowing 'mirroring' of smartphone display on the infotainment touch-screen via USB connection. Display and operation of certified apps including audio and voice control (if supported by the app). Usage of certified apps only while driving. <i>Only operable in conjunction with compatible smartphones including iPhone 5 and above. Please see www.volkswagen.co.uk to check smartphone compatibility</i>	<input type="radio"/>	<input type="radio"/>	<input type="radio"/>	145.83	175.00
<b>'Dynaudio Excite' soundpack</b>	Including 8 channel digital amplifier, Digital Signal Processor (DSP), 300 watt output and 8 speakers	<input type="radio"/>	<input type="radio"/>	<input type="radio"/>	404.17	485.00
<b>Voice activation</b>	Spoken voice commands for telephone and navigation (when fitted) functions	<input type="radio"/>	<input type="radio"/>	<input type="radio"/>	158.33	190.00

## SAFETY AND SECURITY

<b>Integrated child seats with standard or leather upholstery<sup>1</sup></b>	1 child seat, 2nd row, left. <i>Not with Isofix child seats</i>	<input type="radio"/>	<input type="radio"/>	<input type="radio"/>	187.50	225.00
	2 child seats, 2nd row, outer. <i>Not with Isofix child seats</i>	<input type="radio"/>	<input type="radio"/>	<input type="radio"/>	354.17	425.00

1 Some parts of leather interior will contain artificial leather.

● Standard equipment ○ Optional equipment – Not available. Factory-fitted options are subject to availability and extended delivery.

Volkswagen UK may change RRP's at any time (this includes where there are government changes in regulation and/or legislation).  
There may be a delay to any RRP displaying correctly on our materials. Always obtain prices from your chosen authorised Volkswagen retailer.

VAT IS CALCULATED AT 20%. EFFECTIVE FROM 1 APRIL 2020.

# Factory-fitted options.

## COMFORT AND CONVENIENCE

		S	SE Nav	SEL	Basic RRP £ Excluding VAT	Total RRP £ Including VAT
<b>Climate control</b>	Separate controls for 3Zone electronic air conditioning for rear seat passengers, located in rear of front centre armrest	<input type="radio"/>	<input type="radio"/>	<input type="radio"/>	100.00	120.00
<b>Electric rear sliding doors</b>		<input type="radio"/>	<input type="radio"/>	<input type="radio"/>	545.83	655.00
<b>Electrically foldable door mirrors</b>	Including reverse activated kerb-view adjustment on passenger's door mirror	<input type="radio"/>	<input type="radio"/>	<input type="radio"/>	120.83	145.00
<b>Keyless entry</b>	Including Start/Stop button on centre console	<input type="radio"/>	<input type="radio"/>	<input type="radio"/>	316.67	380.00
	Including Start/Stop button on centre console, electric tailgate with hands free tailgate opening and push-button electric closing. <i>Not with tailgate, electric</i>	<input type="radio"/>	<input type="radio"/>	<input type="radio"/>	695.83	835.00
<b>Panoramic sunroof</b>	Electric, sliding glass, including black roof rails	<input type="radio"/>	<input type="radio"/>	<input type="radio"/>	1,041.67	1,250.00
	Electric, sliding glass	<input type="radio"/>	<input type="radio"/>	<input checked="" type="radio"/>	850.00	1,020.00
<b>Power-latching for manual rear sliding doors</b>	Electric power-latching for final stage closing of manual rear sliding doors	<input type="radio"/>	<input type="radio"/>	<input type="radio"/>	195.83	235.00
<b>Retractable roller blind for rear side window</b>		<input type="radio"/>	<input type="radio"/>	<input type="radio"/>	83.33	100.00
<b>Smoking pack</b>	Front and rear ashtray with lighter in front	<input type="radio"/>	<input type="radio"/>	<input type="radio"/>	29.17	35.00
<b>Tailgate, electric</b>	Remote electric tailgate opening and push-button electric closing	<input type="radio"/>	<input type="radio"/>	<input type="radio"/>	433.33	520.00
<b>Winter pack</b>	Heated front seats, heated windscreen washer jets. <i>Not with leather upholstery</i>	<input type="radio"/>	<input type="radio"/>	<input checked="" type="radio"/>	179.17	215.00

● Standard equipment ○ Optional equipment – Not available. Factory-fitted options are subject to availability and extended delivery.

Volkswagen UK may change RRP's at any time (this includes where there are government changes in regulation and/or legislation).  
There may be a delay to any RRP displaying correctly on our materials. Always obtain prices from your chosen authorised Volkswagen retailer.

VAT IS CALCULATED AT 20%. EFFECTIVE FROM 1 APRIL 2020.

# Factory-fitted options.

## DRIVER'S ASSISTANCE

		S	SE Nav	SEL	Basic RRP £ Excluding VAT	Total RRP £ Including VAT
<b>Cruise control</b>	<i>Only in conjunction with leather trimmed multifunction steering wheel</i>	<input type="radio"/>	<input checked="" type="radio"/> <sup>1</sup>	<input checked="" type="radio"/> <sup>1</sup>	162.50	195.00
<b>Dynamic Light Assist</b>	Automatic sensors detect other road users and cover part of the headlights appropriately. If dazzling other road users cannot be prevented, the light distribution is automatically set to dipped beam headlights. <i>Only in conjunction with Gas discharge (Xenon) dipped beam headlights</i>	<input type="radio"/>	<input type="radio"/>	<input type="radio"/>	312.50	375.00
<b>High beam assist<sup>2</sup></b>	Automatic sensing for switching between dipped and main beam	<input type="radio"/> <sup>3</sup>	<input type="radio"/>	<input type="radio"/>	112.50	135.00
<b>Multifunction colour display</b>	Colour display for multifunction computer	<input type="radio"/>	<input type="radio"/>	<input type="radio"/>	154.17	185.00
<b>Park Assist</b>	Automated steering assistant for parallel parking, manoeuvres into spaces only 1.1m longer than the vehicle	<input type="radio"/>	<input type="radio"/>	<input type="radio"/>	279.17	335.00
<b>Park Assist with parking sensors front and rear</b>	Automated steering assistant for parallel parking, manoeuvres into spaces only 1.1m longer than the vehicle. Ultrasonic and audible parking sensors, with audio volume reduction when activated and optical parking display via vehicle's infotainment system and multifunction computer	<input type="radio"/>	<input type="radio"/>	<input type="radio"/>	645.83	775.00
<b>Parking sensors, front and rear</b>	Ultrasonic and audible parking sensors, with audio volume reduction when activated and optical parking display via vehicle's infotainment system	<input type="radio"/>	<input checked="" type="radio"/>	<input checked="" type="radio"/>	404.17	485.00
<b>Rear-view camera</b>	Displayed via vehicle's infotainment system display	<input type="radio"/>	<input type="radio"/>	<input type="radio"/>	275.00	330.00
<b>XDS electronic differential lock</b>	Electronic system to improve traction and handling – 2.0 TDI 150 PS engine only. Standard on 2.0 TDI 177 PS and 2.0 TDI 184 PS engines	<input type="radio"/>	<input type="radio"/>	<input type="radio"/>	170.83	205.00

1 Cruise control forms part of Adaptive Cruise Control (ACC). 2 Not in conjunction with gas discharge (Xenon) dipped beam headlights. 3 Must be ordered in conjunction with Convenience pack.

● Standard equipment ○ Optional equipment – Not available. Factory-fitted options are subject to availability and extended delivery.

Volkswagen UK may change RRP's at any time (this includes where there are government changes in regulation and/or legislation). There may be a delay to any RRP displaying correctly on our materials. Always obtain prices from your chosen authorised Volkswagen retailer.

VAT IS CALCULATED AT 20%. EFFECTIVE FROM 1 APRIL 2020.



[Configure now >](#)

# Accessories. Your Volkswagen your way.

	Part number	Total RRP £ Including VAT	Total fitted RRP £ Including VAT		Part number	Total RRP £ Including VAT	Total fitted RRP £ Including VAT
<b>PROTECTION AND CAR CARE</b>							
Rubber floor mats – front – black	7N2 061 501 041	53.00	-	Semi-rigid loadliner – 5 seater	7N0 061 161	95.00	-
Rubber floor mats – middle – black	7N0 061 510 041	48.00	-	Semi-rigid loadliner – 7 seater	7N0 061 161 A	67.00	-
Rubber floor mats – rear – black	7N0 061 511 041	49.00	-	Flexible loadliner – 5 seater	7N0 061 160	70.00	-
Mudflaps – front	7N0 075 111	-	105.00	Summer car care kit	000 096 355 D	26.50	-
Mudflaps – rear	7N0 075 101	-	105.00	Winter car care kit	000 096 352 L	21.50	-
Luxury carpet mat set	7N2 061 270 WGK	95.00	-	Protective film for the door sills – 4 pieces	7N0 071 310 19A	-	142.00
<b>TRAVEL AND TRANSPORT</b>							
Volkswagen roof box – 340 litres – black	000 071 200	235.00	-	Volkswagen child seat G1 ISOFIX DUO Plus	5H0 019 909	340.00	-
Load bars	7N0 071 151	253.00	-	Wind deflectors – front – 2 pieces	7N0 072 193 HU3	-	86.00
Compact III towbar mounted bicycle carrier	3C2 071 105 A	577.00	-	Waste bag	000 061 107	23.50	-
Tailgate bicycle holder	7N0 071 104	494.00	-	Clothes hanger	00V 061 127	29.30	-
Ski and snowboard holder – 6 pairs of skis or 4 snowboards	000 071 129 N	138.00	-	Sunblinds – side windows, second row	7N0 064 363	130.00	166.00
Partition grille (dog guard) – transverse for 7 seater	7N0 017 221 C	331.00	367.00	Sunblinds – rear doors third row and rear window	7N0 064 365	212.00	248.00
Safety kit	000 093 059	25.00	-	Towbar – detachable, including electrical installation kit	7N0 092 155	-	985.00
<b>STYLING AND TECHNOLOGY</b>							
Door sill trim – steel (5-door), 4 treadplates	7N0 071 303	-	195.00	Exterior mirror caps with stainless steel look	5N0 072 530 Q91	-	162.00
Meta Trak S5-VTS – GPS Tracker including 1 year subscription	ZGB 000 054 208	-	499.00	Rear roof spoiler (primed) <sup>1</sup>	7N0 071 644 GRU	-	389.00

<sup>1</sup> Price excludes painting.

Accessory prices are the manufacturer's Recommended Retail Prices (RRP), shown exclusive and inclusive of fitting where applicable, inclusive of appropriate VAT, and are charged in addition to recommended 'On the road' retail price paid for the vehicle. For full details, please contact your authorised Volkswagen retailer.

Volkswagen UK may change RRP's at any time (this includes where there are government changes in regulation and/or legislation). There may be a delay to any RRP displaying correctly on our materials. Always obtain prices from your chosen authorised Volkswagen retailer.

VAT IS CALCULATED AT 20%, EXCEPT RETAILER SUPPLIED CHILD SAFETY SEATS WHERE IT IS CALCULATED AT 5%. EFFECTIVE FROM 1 APRIL 2020.

[The Sharan](#)[Model prices](#)[Standard equipment](#)[Multimedia](#)[Driver's assistance systems](#)[Factory-fitted options](#)[Accessories](#)[Wheels](#)[Paint](#)[Upholstery](#)[Combinations](#)[Dimensions](#)[VED and additional 'On the road' costs](#)[Environmental information](#)[AdBlue®](#)[CO<sub>2</sub> emissions, BIK % and VED Bands with optional wheels](#)[Company car taxation chart and comparison](#)[Volkswagen service and service plan](#)

# Wheels.



01 S



02 SE S



03 SEL



04 SE



05 SE SEL



06 SE SEL



07 SE SEL

01 6 1/2 J x 16" steel wheels and full size wheel trims with 205/60 R16 self-sealing tyres.

02 'Memphis' 6 1/2 J x 16" alloy wheels with 215/60 R16 super low rolling resistance tyres and anti-theft wheel bolts.

03 'Sydney' 7 J x 17" alloy wheels with 225/50 R17 self-sealing tyres and anti-theft wheel bolts.

04 'Jakarta' 6 1/2 J x 16" alloy wheels with 215/60 R16 super low rolling resistance tyres and anti-theft wheel bolts.

05 'Stratford' 7 J x 17" alloy wheels with 225/50 R17 tyres and anti-theft wheel bolts.

06 'Marseille' 7 1/2 J x 18" alloy wheels with 225/45 R18 tyres, anti-theft wheel bolts and sports suspension (lowered by approximately 15mm).

07 'Toulon' 7 1/2 J x 18" alloy wheels with 225/45 R18 tyres, anti-theft wheel bolts and sports suspension (lowered by approximately 15mm).

Please note, choosing larger alloy wheels than standard, as an option, may result in increased fuel consumption. This is due to the fact that larger wheels have both more aerodynamic drag and more mechanical drag, resulting in increased rolling resistance and increased wind resistance. Images shown feature optional metallic paint.

Standard Optional  
S | S SE | SE Nav SEL | SEL

# Paint.



01  S  SE  SEL



02  S  SE  SEL



03  S  SE  SEL

- 01 'Pure White' Non-Metallic 0Q
- 02 'Urano Grey' Non-Metallic 5K
- 03 'Reflex Silver' Metallic 8E
- 04 'Atlantic Blue' Metallic H7
- 05 'Dark Oak Brown Metallic P0
- 06 'Indium Grey' Metallic X3
- 07 'Deep Black' Pearl Effect 2T



04  S  SE  SEL



05  S  SE  SEL



06  S  SE  SEL



07  S  SE  SEL

Standard    Optional  
**S** | **S**   **SE** | **SE Nav**   **SEL** | **SEL**

Images shown feature optional 18" 'Marseille' alloy wheels.

Please note: Colour range is reproduced for illustration purposes only. Actual on-car colours may vary from those shown, as screen technology does not allow exact reproduction of the paint colours.

[Configure now >](#)



# Upholstery.

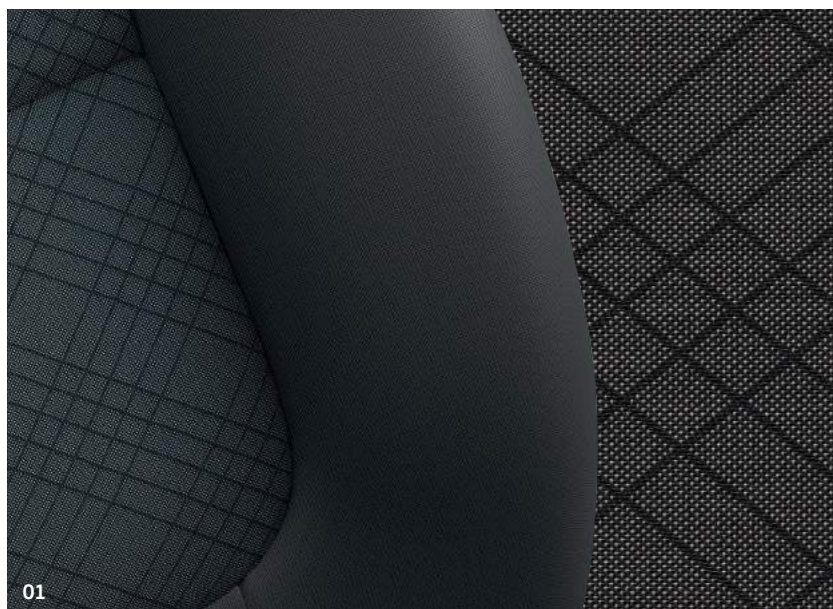

01

**S**

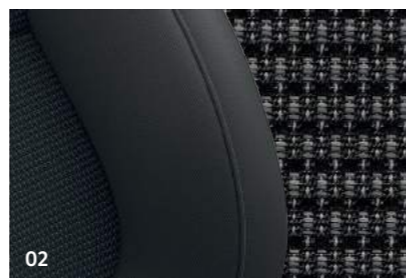

02

**SE**

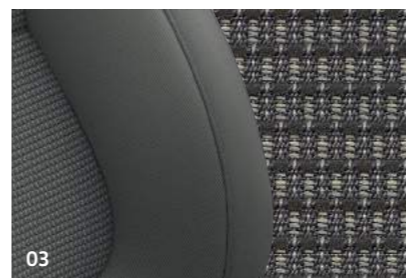

03

**SE**

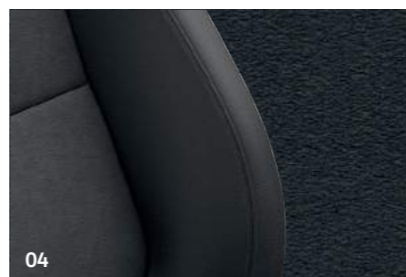

04

**SEL**



05

**SEL**



06

**SEL**



07

**SE SEL**



08

**SE SEL**

01 'Campus' cloth Titan Black BY

02 'Stripes' cloth Titan Black BY

03 'Stripes' cloth Palladium Grey BW

04 Alcantara seat centre section and 'Vienna' leather side bolsters Titan Black BY

05 Alcantara seat centre section and 'Vienna' leather side bolsters Palladium Grey BW

06 Alcantara seat centre section and 'Vienna' leather side bolsters Cornsilk Beige XU

07 'Vienna' leather\* Titan Black BY

08 'Vienna' leather\* Bonanza/Titan Black UU

**Standard**  Optional

S | S **SE** | SE Nav **SEL** | SEL

\* Some parts of leather interior will contain artificial leather.

Please note: Swatches reproduced for illustration purposes only. Actual upholstery colours may vary from those shown, as screen technology does not allow exact reproduction of the upholstery colours.

# Combinations.

	Carpet	Dashboard	Pure White 0Q Non-Metallic*	Urano Grey 5K Non-Metallic	Reflex Silver 8E Metallic*	Atlantic Blue H7 Metallic*	Dark Oak Brown P0 Metallic*	Indium Grey X3 Metallic*	Deep Black 2T Pearl Effect*
<b>'Campus' cloth</b> <b>Standard on S models</b> Titan Black BY	Titan Black	Titan Black/Titan Black	●	●	●	●	●	●	●
<b>'Stripes' cloth</b> <b>Standard on SE Nav models</b> Titan Black BY	Titan Black	Titan Black/Titan Black	●	●	●	●	●	●	●
Palladium Grey BW	Titan Black	Titan Black/Palladium Grey	●	●	●	●	●	●	●
<b>Alcantara seat centre section with 'Vienna' leather<sup>†</sup> side bolsters</b> <b>Standard on SEL models</b> Titan Black BY	Titan Black	Titan Black/Titan Black	●	●	●	●	●	●	●
Palladium Grey BW	Titan Black	Titan Black/Palladium Grey	●	●	●	●	●	●	●
Cornsilk Beige XU	Titan Black	Titan Black/Cornsilk Beige	●	●	●	●	●	●	●
<b>'Vienna' leather*<sup>†</sup></b> <b>Optional on SE Nav and SEL models</b> Titan Black BY	Titan Black	Titan Black/Titan Black	○	○	○	○	○	○	○
Bonanza/Titan Black UU	Titan Black	Titan Black/Titan Black	○	○	○	○	○	○	○

\* Pure White non-metallic, metallic and pearl effect paints, and leather upholstery are optional at extra cost.  
 † Some parts of leather interior will contain artificial leather.  
 ● Standard. ○ Optional at extra cost.

# Dimensions.

## Exterior dimensions

Length, mm	4854
Width – excl. door mirrors, mm	1904
Height, mm	1720
Height – opened tailgate/floor, mm	2052
Wheelbase, mm	2920
Turning circle, m	11.9

## Interior dimensions

Effective headroom – front, mm (with sunroof)	1077 (1059)
Effective headroom – 2nd row rear, mm (with sunroof)	973 (973)
Effective headroom – 3rd row rear, mm	945
Interior width, front, mm	1507
Interior width – 2nd row rear, mm	1578
Interior width – 3rd row rear, mm	1254

## Luggage dimensions

Length – seats up, mm	344
Length – seats down, mm	1892
Maximum width, mm	1048
Maximum height, mm	561
Floor to roof height, mm	932

## Maximum luggage capacity, litres – VDA measuring method using 200 x 100 x 50mm blocks

With rear seats upright	300
With rear seats folded	2297

Figures shown are for standard specification models. The addition of certain factory-fitted options and/or accessories may affect some of the dimensions shown.

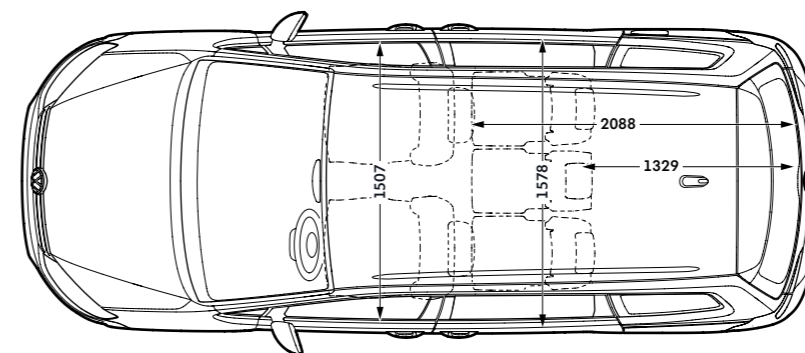
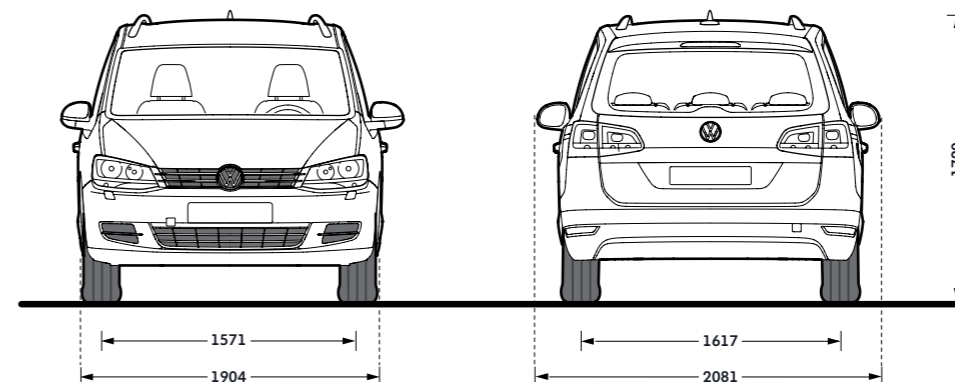
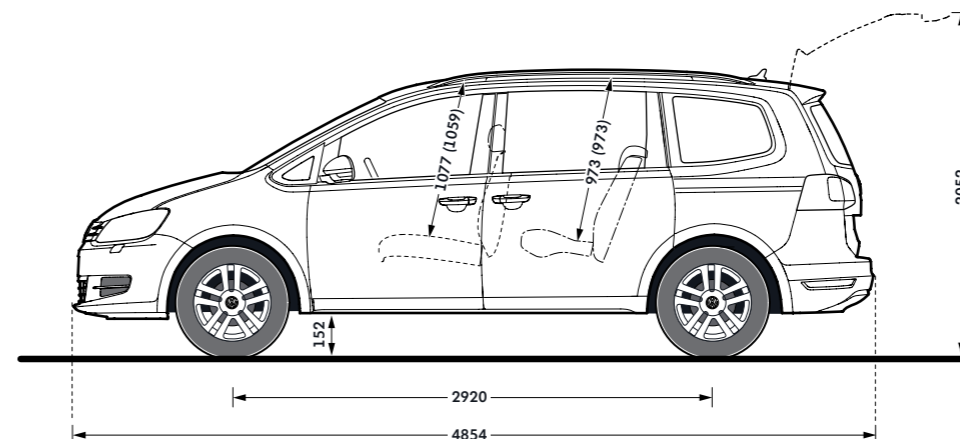

On illustrations, where arrows and figures are shown inside of the vehicle, the measurements are for interior dimensions. Where arrows and figures are shown outside of the vehicle, the measurements are for exterior dimensions.

# VED and additional 'On the road' costs.

Diesel vehicles that do not meet the RDE2 standard will be charged a supplement on their 'First year rate' to the effect of moving up by one VED (Vehicle Excise Duty) band. The following tables give the rates of vehicle tax on cars registered on or after 1 April 2020. Please refer to the Model Prices pages to confirm which models are RDE2 compliant.

## 'FIRST YEAR RATE' VED – CARS REGISTERED ON OR AFTER 1.4.2020 BASED ON CO<sub>2</sub> EMISSIONS AND FUEL TYPE

**Petrol/Diesel<sup>†</sup> – 'First year rate' VED**

CO <sub>2</sub> emissions (g/km)	Petrol/Diesel <sup>†</sup> VED £	Petrol total 'On the road' costs £
0	0.00	690.00
1-50	10.00	700.00
51-75	25.00	715.00
76-90	110.00	800.00
91-100	135.00	825.00
101-110	155.00	845.00
111-130	175.00	865.00
131-150	215.00	905.00
151-170	540.00	1,230.00
171-190	870.00	1,560.00
191-225	1,305.00	1,995.00
226-255	1,850.00	2,540.00
Over 255	2,175.00	2,865.00

**Diesel<sup>‡</sup> – 'First year rate' VED**

CO <sub>2</sub> emissions (g/km)	Diesel <sup>‡</sup> VED £	Diesel total 'On the road' costs £
0	0.00	690.00
1-50	25.00	715.00
51-75	110.00	800.00
76-90	135.00	825.00
91-100	155.00	845.00
101-110	175.00	865.00
111-130	215.00	905.00
131-150	540.00	1,230.00
151-170	870.00	1,560.00
171-190	1,305.00	1,995.00
191-225	1,850.00	2,540.00
226-255	2,175.00	2,865.00
Over 255	2,175.00	2,865.00

**Alternative fuel – 'First year rate' VED**

CO <sub>2</sub> emissions (g/km)	Alternative fuel VED £	Alternative fuel total 'On the road' costs £
0	0.00	690.00
1-50	0.00	690.00
51-75	15.00	705.00
76-90	100.00	790.00
91-100	125.00	815.00
101-110	145.00	835.00
111-130	165.00	855.00
131-150	205.00	895.00
151-170	530.00	1,220.00
171-190	860.00	1,550.00
191-225	1,295.00	1,985.00
226-255	1,840.00	2,530.00
Over 255	2,165.00	2,855.00

The way VED (Vehicle Excise Duty) vehicle tax is calculated will change for vehicles that are first registered with the DVLA on, or after, 1 April 2018. All new diesel vehicles registered after 1 April 2018 that do not meet the RDE2 standard will be charged a supplement on their 'First year rate' to the effect of moving up by one VED (Vehicle Excise Duty) band.

If a new vehicle is registered on or after 1 April 2018, after the 'First year rate' VED the majority of vehicles move to the 'Standard rate' of vehicle tax which is £150 a year.

The 'First year rate' will be based on the CO<sub>2</sub> emissions, fuel type and the list price of the vehicle supplied by the Manufacturer or Retailer as applicable on the day before the vehicle is first registered and taxed.

After the 'First year rate', all vehicles with zero emissions will be exempt from the 'Standard rate' of vehicle tax. All petrol and diesel vehicles will pay a standard rate of £150 a year, and alternative fuel vehicles will pay a standard rate of £140 a year.

Petrol or diesel vehicles with a list price over £40,000 at first registration will pay £475 a year, after the first 'First year rate' vehicle tax, for a period of five years. This comprises the £150 'Standard rate' and £325 additional rate. After five years the vehicle tax will revert to the 'Standard rate' of £145 per year.

Alternative fuel vehicles – hybrids, bi-ethanol or LPG, with a list price over £40,000 at first registration will pay £465 a year after the 'First year rate' vehicle tax for a period of five years. This comprises the £140 'Standard rate' and £325 additional rate which reverts to £140 'Standard rate' after five years.

Vehicles with a list price exceeding £40,000 with zero emissions (including electric) will pay the additional rate of £325 a year for a further five year period, after the 'First year rate' tax. After the five year period these vehicles will pay zero VED tax.

<sup>†</sup> Diesel cars that are tested to RDE2 standards. <sup>‡</sup> Diesel cars, including those tested to RDE standards.

## 'STANDARD RATE' VED

**'Standard rate' VED based on fuel type**

Fuel type	CO <sub>2</sub> emissions (g/km)	'Standard rate' 12 months VED £
Electric/Other	0	0.00
Petrol/Diesel	1 - Over 255	150.00
Alternative	1 - Over 255	140.00

After the 'First year rate', all vehicles with zero emissions will be exempt from the 'Standard rate' of vehicle tax. All petrol and diesel vehicles will pay a standard rate of £150 a year, and alternative fuel vehicles will pay a standard rate of £140 a year.

## 'STANDARD RATE' – OVER £40,000 RRP

**'Standard rate' VED for vehicles over £40,000 list price – five year annual rate**

Fuel type	'Standard rate' 12 months VED £	Additional rate £	Total annual payment £
Electric	0.00	325.00	325.00
Petrol/Diesel	150.00	325.00	475.00
Alternative	140.00	325.00	465.00

Petrol or diesel vehicles with a list price over £40,000 at first registration pay £475 a year after the 'First year rate' for a period of five years. Alternative fuel vehicles over £40,000 at first registration – hybrids, bi-ethanol or LPG, pay £465 a year after the 'First year rate' for a period of five years. Electric or vehicles producing zero emissions over £40,000 at first registration pay £325 a year after the 'First year rate' for a period of five years. After five years, vehicles will revert to their 'Standard rate' tax depending on fuel type.

## ADDITIONAL 'OTR' COSTS

**Additional 'On the road' costs**

Delivery to retailer	509.17
Number plates	20.00
VAT	105.83
Vehicle first registration fee	55.00
<b>Total</b>	<b>690.00</b>

The total 'On the road' costs above for petrol, diesel, electric and alternative fuel vehicles include the applicable 'First year rate' VED charge plus the 'On the road' costs as detailed above.

VAT IS CALCULATED AT 20%. EFFECTIVE FROM 1 APRIL 2020.

# Environmental information.

Cars registered on or after 1.4.2020.

5-DOOR MPV RANGE – 7 SEATS.		RDE2 Compliant	Fuel	Transmission	Output, PS	CO <sub>2</sub> emission, g/km <sup>1</sup> , Min. WLTP test cycle	CO <sub>2</sub> emission, g/km <sup>1</sup> , Max. WLTP test cycle	Combined <sup>1</sup> fuel consumption mpg, Min.	Combined <sup>1</sup> fuel consumption mpg, Max.	Combined <sup>1</sup> fuel consumption ltr/100km, Min.	Combined <sup>1</sup> fuel consumption ltr/100km, Max.
S <sup>††</sup>	1.4 ltr TSI <sup>††</sup>	No	Petrol	6-spd manual	150	176	186	34.4	36.2	8.2	7.8
	2.0 ltr TDI SCR <sup>††</sup>	No	Diesel	6-spd manual	150	166	174	42.8	44.8	6.6	6.3
	2.0 ltr TDI SCR <sup>††</sup>	No	Diesel	6-spd auto DSG	150	176	184	40.4	42.2	7.0	6.7
SE NAV <sup>‡</sup>	1.4 ltr TSI <sup>‡</sup>	No	Petrol	6-spd manual	150	172	186	34.4	37.2	8.2	7.6
	1.4 ltr TSI <sup>‡</sup>	No	Petrol	6-spd auto DSG	150	186	201	31.7	34.4	8.9	8.2
	2.0 ltr TDI SCR <sup>‡</sup>	No	Diesel	6-spd manual	150	169	174	42.8	44.1	6.6	6.4
	2.0 ltr TDI SCR <sup>‡</sup>	No	Diesel	6-spd auto DSG	150	179	184	40.4	41.5	7.0	6.8
	2.0 ltr TDI SCR <sup>‡</sup>	No	Diesel	6-spd auto DSG	177	182	186	39.8	40.9	7.1	6.9
SEL <sup>‡</sup>	2.0 ltr TDI SCR <sup>‡</sup>	No	Diesel	6-spd manual	150	170	174	42.8	43.5	6.6	6.5
	2.0 ltr TDI SCR <sup>‡</sup>	No	Diesel	6-spd auto DSG	150	180	184	40.4	40.9	7.0	6.9
	2.0 ltr TDI SCR <sup>‡</sup>	No	Diesel	6-spd auto DSG	177	182	187	39.8	40.4	7.1	7.0

<sup>1</sup> Figures shown are for comparability purposes; only compare fuel consumption and CO<sub>2</sub> figures with other vehicles tested to the same technical procedures. These figures may not reflect real life driving results, which will depend upon a number of factors including the accessories fitted (post-registration), variations in weather, driving styles and vehicle load. Data correct at 1.4.2020. Figures quoted are for a range of configurations (including non-UK) and are subject to change due to ongoing approvals/changes. For more information, please see [www.volkswagen.co.uk/need-help/wltp](http://www.volkswagen.co.uk/need-help/wltp) or consult your authorised Volkswagen retailer.

<sup>‡</sup> These vehicles are WLTP (Worldwide Harmonised Light-Duty Vehicles Test Procedure) type approved vehicles. More information is available at [www.volkswagen.co.uk/need-help/wltp](http://www.volkswagen.co.uk/need-help/wltp).

<sup>†</sup> Please note these models may no longer be available to order, or only available from stock and not available to factory order.

SCR (Selective Catalytic Reduction) requires AdBlue<sup>®</sup>, [please click here](#) or visit [www.volkswagen.co.uk/technology/engines/adblue](http://www.volkswagen.co.uk/technology/engines/adblue) for more details.

RDE2 refers to Real Driving Emissions Step 2.

EFFECTIVE FROM 1 APRIL 2020.



# AdBlue®

Your Volkswagen car is fitted with an advanced emissions control system, which helps your vehicle meet EURO 6 exhaust gas regulations.

## How does the system work?

AdBlue®, a water/urea based additive, is stored in a tank (like diesel fuel), however, unlike fuel it is not injected into the engine, but directly into a specially modified part of the vehicle's exhaust. This begins a chemical reaction which removes the polluting oxides of nitrogen (NOx), converting them into harmless oxygen and nitrogen in a process known as Selective Catalytic Reduction, or SCR for short. SCR is only applicable to diesel engines and the more economically you drive, typically, the less AdBlue® you will use.

The size of the AdBlue® tank fitted to your car will vary depending on which Volkswagen model you have, therefore the interval between top-ups will vary. In addition, many factors such as mileage, journey type, driving style and environmental conditions can influence how much AdBlue® is consumed. A passenger car can consume approximately 1.5 litres of AdBlue® every 620 miles (1.0–1.5 litres for the Passat and Passat Estate). The chart below details the AdBlue® tank size and location.

Model (SCR derivatives only)	Tank size (Approximately)	AdBlue® tank filler location	Initial warning of low AdBlue® (2,400km/1,500 miles to go) can be expected to occur at:
Sharan	16 litres	Left-hand side of luggage compartment	5,000 to 6,000 miles or sooner*

\* Distances are approximate and the warning light may come on sooner depending on driving style, journey type, engine and vehicle load and environmental conditions.

## How will I know if the system needs topping-up?

A series of warnings will be given via the driver information system, accompanied by advice/messages.

The first message is displayed when the remaining range is approximately 1,500 miles, and is repeated every 62 miles until the range reaches 1,000 miles, at which point the warning turns amber. This warning is repeated every 31 miles and is accompanied by an audible tone. If these warnings are not acted upon, the warning turns red; once this happens the car will not restart once the ignition is turned off. This is not a fault, but a required feature of the system. If this stage is reached the system will need a full top-up before the car can be restarted. Further information is available in the vehicle handbook.

## Why should I use a Volkswagen Authorised repairer for top-ups?

- AdBlue® top-ups at authorised repairers are extremely competitive and charged by the litre, so you only pay for what you need
- Authorised repairer staff are trained to handle AdBlue®
- AdBlue® tanks need special adaptors on fillers to ensure there are no spillages
- Volkswagen do not recommend keeping top-up bottles in cars

The top-up bottles supplied by Volkswagen have a capacity of 1.89 litres, and come complete with the adaptor nozzles that fit the Volkswagen AdBlue® tank. These are available from all Volkswagen Authorised repairers.

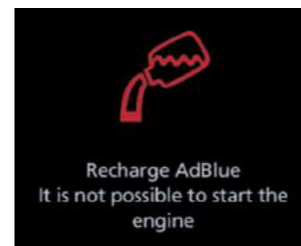
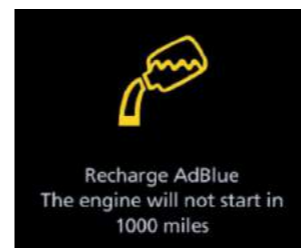
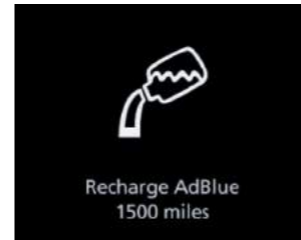

AdBlue® warning lights.

### Important information

- AdBlue® is not a fuel additive. This is why there is a separate AdBlue® tank
- If you put AdBlue® in your fuel tank by mistake, please do not start the engine, but contact a retailer for help
- Put only AdBlue® in the AdBlue® tank; do not fill the AdBlue® tank with any other liquids
- Prevent anything from contaminating AdBlue®
- If small quantities of AdBlue® come into contact with the vehicle's paintwork, for example, wipe them off and if necessary rinse the area with water

EFFECTIVE FROM 1 APRIL 2020.

# CO<sub>2</sub> emissions, BIK % and VED Bands with optional wheels.

## Cars registered on or after 1.4.2020.

### Effect of wheel size on CO<sub>2</sub> emissions, BIK % and VED Bands.

Choosing alternative alloy wheels than standard, as an option, may result in different fuel consumption as well as different CO<sub>2</sub> emissions and subsequently an alternative Vehicle Excise Duty (VED) Band, while BIK rates paid by company car drivers may differ. This is due to the fact that different wheels have both alternative aerodynamic drag and mechanical drag, resulting in different rolling resistance and wind resistance. As a result, the VED Band that the vehicle falls into may differ from its original VED Band when fitted with standard size wheels. In some instances, the recommended 'On the road' retail price paid for the vehicle may change as a result of the change in VED rate. The chart below shows CO<sub>2</sub> emissions and the related VED Bands for vehicles with both standard-fit wheels and larger optional alloy wheels, as well as the different cost payable due to a change in VED Band if applicable.

5-DOOR MPV RANGE – 7 SEATS.			Output, PS	Standard wheel size	CO <sub>2</sub> emission, g/km <sup>1</sup> , WLTP test cycle, standard wheels	First year VED £, standard wheels	BIK % with standard wheel size <sup>2</sup>	Optional alloy wheel and size	CO <sub>2</sub> emission, g/km <sup>1</sup> , WLTP test cycle, optional alloy wheels	First year VED £, optional wheels	BIK % with optional wheel size <sup>2</sup>
S <sup>††</sup>	1.4 ltr TSI <sup>††</sup>	6-spd manual	150	16"	176	870.00	37	16" Memphis	172	870.00	37
	2.0 ltr TDI SCR <sup>††</sup>	6-spd manual	150	16"	166	870.00	37	16" Memphis	169	870.00	37
	2.0 ltr TDI SCR <sup>††</sup>	6-spd auto DSG	150	16"	176	1,305.00	37	16" Memphis	178	1,305.00	37
SE NAV <sup>‡</sup>	1.4 ltr TSI <sup>‡</sup>	6-spd manual	150	16"	172	870.00	37	16" Jakarta	173	870.00	37
			150	16"	172	870.00	37	17" Stratford	180	870.00	37
			150	16"	172	870.00	37	18" Marseille, 18" Toulon	180 <sup>‡</sup>	870.00	37
	1.4 ltr TSI <sup>‡</sup>	6-spd auto DSG	150	16"	186	870.00	37	16" Jakarta	187	870.00	37
			150	16"	186	870.00	37	17" Stratford	194	1,305.00	37
			150	16"	186	870.00	37	18" Marseille, 18" Toulon	194 <sup>‡</sup>	1,305.00	37
	2.0 ltr TDI SCR <sup>‡</sup>	6-spd manual	150	16"	169	870.00	37	16" Jakarta	170	870.00	37
			150	16"	169	870.00	37	17" Stratford	169	870.00	37
			150	16"	169	870.00	37	18" Marseille	169 <sup>‡</sup>	870.00	37
			150	16"	169	870.00	37	18" Toulon	170 <sup>‡</sup>	870.00	37

1 Figures shown are for comparability purposes; only compare fuel consumption and CO<sub>2</sub> figures with other vehicles tested to the same technical procedures. These figures may not reflect real life driving results, which will depend upon a number of factors including the accessories fitted (post-registration), variations in weather, driving styles and vehicle load. Data correct at 1.4.2020. Figures quoted are for a range of configurations (including non-UK) and are subject to change due to ongoing approvals/changes. For more information, please see [www.volkswagen.co.uk/need-help/wltp](http://www.volkswagen.co.uk/need-help/wltp) or consult your authorised Volkswagen retailer.

2 The BIK charges quoted reflect the charges which apply to vehicles registered after 6 April 2020. These charges may differ from any charges displayed or quoted before 6 April 2020. The BIK % figure quoted includes the 4% diesel supplement, where applicable.

Please note: the increase in VED and BIK rate that is payable is in addition to the cost of the optional alloy wheels. Please consult your Volkswagen retailer for full details.

‡ These vehicles are WLTP (Worldwide Harmonised Light-Duty Vehicles Test Procedure) type approved vehicles. More information is available at [www.volkswagen.co.uk/need-help/wltp](http://www.volkswagen.co.uk/need-help/wltp).

† Please note these models may no longer be available to order, or only available from stock and not available to factory order.

‡ Figures shown are in conjunction with Sports suspension.

SCR (Selective Catalytic Reduction) requires AdBlue<sup>®</sup>, [please click here](#) or visit [www.volkswagen.co.uk/technology/engines/adblue](http://www.volkswagen.co.uk/technology/engines/adblue) for more details.

VAT IS CALCULATED AT 20%. EFFECTIVE FROM 1 APRIL 2020.

# CO<sub>2</sub> emissions, BIK % and VED Bands with optional wheels.

## Cars registered on or after 1.4.2020.

### Effect of wheel size on CO<sub>2</sub> emissions, BIK % and VED Bands.

Choosing alternative alloy wheels than standard, as an option, may result in different fuel consumption as well as different CO<sub>2</sub> emissions and subsequently an alternative Vehicle Excise Duty (VED) Band, while BIK rates paid by company car drivers may differ. This is due to the fact that different wheels have both alternative aerodynamic drag and mechanical drag, resulting in different rolling resistance and wind resistance. As a result, the VED Band that the vehicle falls into may differ from its original VED Band when fitted with standard size wheels. In some instances, the recommended 'On the road' retail price paid for the vehicle may change as a result of the change in VED rate. The chart below shows CO<sub>2</sub> emissions and the related VED Bands for vehicles with both standard-fit wheels and larger optional alloy wheels, as well as the different cost payable due to a change in VED Band if applicable.

5-DOOR MPV RANGE – 7 SEATS.			Output, PS	Standard wheel size	CO <sub>2</sub> emission, g/km <sup>1</sup> , WLTP test cycle, standard wheels	First year VED £, standard wheels	BIK % with standard wheel size <sup>2</sup>	Optional alloy wheel and size	CO <sub>2</sub> emission, g/km <sup>1</sup> , WLTP test cycle, optional alloy wheels	First year VED £, optional wheels	BIK % with optional wheel size <sup>2</sup>
SE NAV‡	2.0 ltr TDI SCR‡	6-spd auto DSG	150	16"	179	1,305.00	37	16" Jakarta, 17" Stratford	179	1,305.00	37
			150	16"	179	1,305.00	37	18" Marseille	179†	1,305.00	37
			150	16"	179	1,305.00	37	18" Toulon	180†	1,305.00	37
	2.0 ltr TDI SCR‡	6-spd auto DSG	177	16"	182	1,305.00	37	18" Marseille, 18" Toulon	182†	1,305.00	37
SEL‡	2.0 ltr TDI SCR‡	6-spd manual	150	17"	170	870.00	37	17" Stratford	170	870.00	37
			150	17"	170	870.00	37	18" Marseille, 18" Toulon	170†	870.00	37
	2.0 ltr TDI SCR‡	6-spd auto DSG	150	17"	180	1,305.00	37	17" Stratford	180	1,305.00	37
			150	17"	180	1,305.00	37	18" Marseille, 18" Toulon	180†	1,305.00	37
	2.0 ltr TDI SCR‡	6-spd auto DSG	177	17"	182	1,305.00	37	17" Stratford	183	1,305.00	37
			177	17"	182	1,305.00	37	18" Marseille, 18" Toulon	183†	1,305.00	37

1 Figures shown are for comparability purposes; only compare fuel consumption and CO<sub>2</sub> figures with other vehicles tested to the same technical procedures. These figures may not reflect real life driving results, which will depend upon a number of factors including the accessories fitted (post-registration), variations in weather, driving styles and vehicle load. Data correct at 1.4.2020. Figures quoted are for a range of configurations (including non-UK) and are subject to change due to ongoing approvals/changes. For more information, please see [www.volkswagen.co.uk/need-help/wltp](http://www.volkswagen.co.uk/need-help/wltp) or consult your authorised Volkswagen retailer.

2 The BIK charges quoted reflect the charges which apply to vehicles registered after 6 April 2020. These charges may differ from any charges displayed or quoted before 6 April 2020. The BIK % figure quoted includes the 4% diesel supplement, where applicable. Please note: the increase in VED and BIK rate that is payable is in addition to the cost of the optional alloy wheels. Please consult your Volkswagen retailer for full details.

‡ These vehicles are WLTP (Worldwide Harmonised Light-Duty Vehicles Test Procedure) type approved vehicles. More information is available at [www.volkswagen.co.uk/need-help/wltp](http://www.volkswagen.co.uk/need-help/wltp).

† Please note these models may no longer be available to order, or only available from stock and not available to factory order.

‡ Figures shown are in conjunction with Sports suspension.

SCR (Selective Catalytic Reduction) requires AdBlue®, [please click here](#) or visit [www.volkswagen.co.uk/technology/engines/adblue](http://www.volkswagen.co.uk/technology/engines/adblue) for more details.

VAT IS CALCULATED AT 20%. EFFECTIVE FROM 1 APRIL 2020.

# Company car taxation chart – tax year 2020/21.

Cars registered on or after 1.4.2020.

## How to calculate your company car income tax liability – effective 6.4.2020

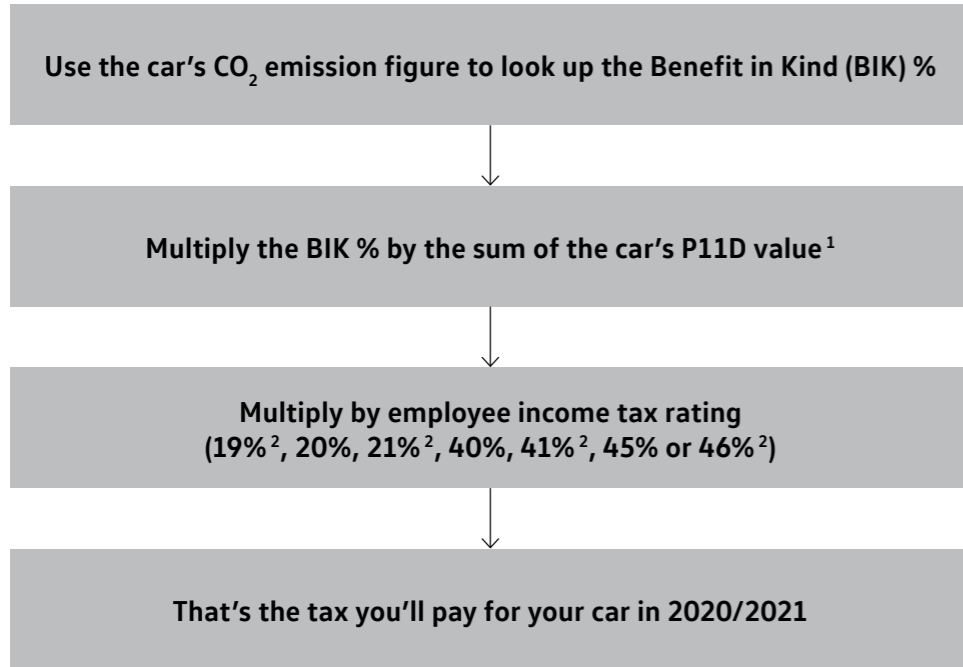

Emissions CO <sub>2</sub> (g/km)	2020/21 Benefit in Kind % (BIK)				2021/22 Benefit in Kind % (BIK)				2022/23 Benefit in Kind % (BIK)			
	Petrol/Diesel <sup>3</sup>	Diesel	Electric range miles	Alternative fuel	Petrol/Diesel <sup>3</sup>	Diesel	Electric range miles	Alternative fuel	Petrol/Diesel <sup>3</sup>	Diesel	Electric range miles	Alternative fuel
0 (EV)												
1-50	12%	16%	130 or above	0%	13%	17%	130 or above	1%	14%	18%	130 or above	2%
51-54	13%	17%	70-129	3%	14%	18%	70-129	4%	15%	19%	70-129	5%
55-59	14%	18%	40-69	6%	15%	19%	40-69	7%	16%	20%	40-69	8%
60-64	15%	19%	30-39	10%	16%	20%	30-39	11%	17%	21%	30-39	12%
65-69	16%	20%	1-29	12%	17%	21%	1-29	13%	18%	22%	1-29	14%
70-74	17%	21%			18%	22%			19%	23%		
75-79	18%	22%			19%	23%			20%	24%		
80-84	19%	23%			20%	24%			21%	25%		
85-89	20%	24%			21%	25%			22%	26%		
90-94	21%	25%			22%	26%			23%	27%		
95-99	22%	26%			23%	27%			24%	28%		
100-104	23%	27%			24%	28%			25%	29%		
105-109	24%	28%			25%	29%			26%	30%		
110-114	25%	29%			26%	30%			27%	31%		
115-119	26%	30%			27%	31%			28%	32%		
120-124	27%	31%			28%	32%			29%	33%		
125-129	28%	32%			29%	33%			30%	34%		
130-134	29%	33%			30%	34%			31%	35%		
135-139	30%	34%			31%	35%			32%	36%		
140-144	31%	35%			32%	36%			33%	37%		
145-149	32%	36%			33%	37%			34%	37%		
150-154	33%	37%			34%	37%			35%	37%		
155-159	34%	37%			35%	37%			36%	37%		
160-164	35%	37%			36%	37%			37%	37%		
165-169	36%	37%			37%	37%			37%	37%		
170+	37%	37%			37%	37%			37%	37%		

Taxable percentage of P11D value (Diesel figures include the 4% diesel supplement)

The government is retaining the diesel supplement in company car tax until 2021, when EU-wide testing procedures will ensure new diesel cars meet air quality standards even under strict 'real world' driving conditions. From 6 April 2018 drivers must add 4% to their appropriate percentage if the car is propelled solely by diesel (up to a maximum of 37%).

For further details of company car tax, please consult your authorised Volkswagen retailer, or visit [www.volkswagen.co.uk/offers-and-finance/fleet/calculators/company-car-tax-calculator](http://www.volkswagen.co.uk/offers-and-finance/fleet/calculators/company-car-tax-calculator). Full details can be found at [www.assets.publishing.service.gov.uk/government/uploads/system/uploads/attachment\\_data/file/815268/190617\\_-\\_WLTP\\_-\\_summary\\_of\\_responses\\_v2.2.pdf](http://www.assets.publishing.service.gov.uk/government/uploads/system/uploads/attachment_data/file/815268/190617_-_WLTP_-_summary_of_responses_v2.2.pdf)

- 1 P11D values given in this price list are based on standard specification models with no factory-fitted options or other accessories. If your car includes factory-fitted options or other accessories, you may need to adjust the P11D value to take this into account.
- 2 From 6 April 2018, new income tax rates have been introduced for Scottish Taxpayers, these figures reflect the new Scottish rates. For full details of Scottish BIK tax liability, please refer to the [Benefit In Kind for Scottish Residents section](#)
- 3 Diesel cars that are tested to RDE2 standards.

# Company car taxation comparison.

## Cars registered on or after 1.4.2020.

### 3-year taxation comparison guide.

SHARAN			RDE2 Compliant	Output, PS	CO <sub>2</sub> emission, g/km <sup>1</sup> WLTP test cycle	Basic Recommended Retail £	VAT £	Total Recommended Retail £	Tax year commencing	P11D Value £ <sup>2</sup>	BIK % <sup>3</sup>	Annual cost at 20% <sup>4</sup> tax rate £	Annual cost at 40% <sup>4</sup> tax rate £
SE NAV <sup>‡</sup>	2.0 ltr TDI SCR <sup>‡</sup>	6-spd manual	No	150	169	28,741.67	5,748.33	34,490.00	2020/21	35,125.00	37	2,599.25	5,198.50
									2021/22	35,125.00	37	2,599.25	5,198.50
									2022/23	35,125.00	37	2,599.25	5,198.50
SEL <sup>‡</sup>	2.0 ltr TDI SCR <sup>‡</sup>	6-spd manual	No	150	180	31,858.33	6,371.67	38,230.00	2020/21	38,865.00	37	2,876.01	5,752.02
									2021/22	38,865.00	37	2,876.01	5,752.02
									2022/23	38,865.00	37	2,876.01	5,752.02

1 Figures shown are for comparability purposes; only compare fuel consumption and CO<sub>2</sub> figures with other vehicles tested to the same technical procedures. These figures may not reflect real life driving results, which will depend upon a number of factors including the accessories fitted (post-registration), variations in weather, driving styles and vehicle load. Data correct at 1.4.2020. For more information, please see [www.volkswagen.co.uk/need-help/wltp](http://www.volkswagen.co.uk/need-help/wltp) or consult your authorised Volkswagen retailer.

2 P11D value = Total recommended retail price + delivery to retailer £509.17, + number plates £20, + VAT £105.83 (calculated by reference to total of delivery to retailer + number plates). P11D value is based on standard specification model with no factory-fitted options or other accessories.

3 The BIK charges quoted reflect the charges which apply to vehicles registered after 6 April 2020. These charges may differ from any charges displayed or quoted before 6 April 2020. The BIK % figure quoted includes the 4% diesel supplement, where applicable. Please consult your Volkswagen retailer for full details.

4 From 6 April 2018, new income tax rates have been introduced for Scottish Taxpayers. For full details of Scottish BIK tax liability, please refer to the [Benefit In Kind for Scottish Residents section](#)

‡ These vehicles are WLTP (Worldwide Harmonised Light-Duty Vehicles Test Procedure) type approved vehicles. More information is available at [www.volkswagen.co.uk/need-help/wltp](http://www.volkswagen.co.uk/need-help/wltp).

† Please note this model may no longer be available to order, or only available from stock and not available to factory order.

All examples are for manual derivatives unless otherwise stated.

RDE2 refers to Real Driving Emissions Step 2.

Volkswagen UK may change RRP's at any time (this includes where there are government changes in regulation and/or legislation). There may be a delay to any RRP displaying correctly on our materials. Always obtain prices from your chosen authorised Volkswagen retailer.

VAT IS CALCULATED AT 20%. EFFECTIVE FROM 1 APRIL 2020.

# Volkswagen service.



## VOLKSWAGEN FINANCE<sup>1</sup>

Volkswagen Finance specialises in providing funding solutions for Volkswagen drivers. Whether your Volkswagen is for private or business use, you can choose from a range of funding options.

### Solutions – a Personal Contract Plan

Flexible finance plan designed to allow you to drive a new vehicle sooner than you think. At the end of your agreement you can choose to trade in your Volkswagen for a new one, keep it, or hand it back.

### Hire Purchase

A simple and straightforward way to finance your Volkswagen. Have the option to break down your monthly payments over a period that suits you, making financing your car much more manageable than you think.

### Contract Hire

Available for both personal and business customers. Ideal for customers simply wanting to pay a monthly rental for the vehicle, change it on a regular fixed period and have no disposal risk.

- Lease Purchase
- Finance Lease

With all Volkswagen Finance products you can choose a fixed-cost maintenance plan to help you budget for your servicing and maintenance costs. Buy your service plan online or visit your local Volkswagen retailer for more information.



## VOLKSWAGEN INSURANCE<sup>2</sup>

We want you to start enjoying your new car from day one, and thanks to our complimentary five day Volkswagen Drive Away Insurance you can. Please visit [www.insurewithvolkswagen.co.uk/driveaway](http://www.insurewithvolkswagen.co.uk/driveaway) to activate your cover. If eligible, we will also give you a quotation for our annual insurance, designed specifically for Volkswagen drivers.

## ANNUAL CAR INSURANCE

Volkswagen car insurance helps give you peace of mind with the following benefits at no extra cost:

- Repairs carried out by Volkswagen trained technicians using Volkswagen Genuine Parts and paints when repaired by a Volkswagen approved repairer
- Guaranteed courtesy car
- Child seat replacement
- Uninsured driver promise
- Vandalism promise
- 24 hour accident recovery

For more information or to get a quote, visit [www.insurewithvolkswagen.co.uk](http://www.insurewithvolkswagen.co.uk)

## SERVICING AND MAINTENANCE

Volkswagen is pleased to offer you a choice on how your Volkswagen is serviced. The appropriate selection is entirely dependent on how the car is likely to be driven and its general use. To help you identify which type of service would be most suitable, please refer to the following guide.

### Fixed Service

The Fixed Service is recommended for vehicles that will cover less than 10,000 miles in 12 months and if the vehicle is likely to be used in the following way:

- Predominantly urban driving, short journeys with frequent cold starts.
- Activities regularly producing high engine loading, e.g. frequent hill climbs, driving with vehicle fully loaded and towing.
- Uneconomical driving style using high rpms with heavy acceleration and heavy braking.

The service intervals for the Fixed Service schedule are as follows:

- Oil change service – After 1 year or 10,000 miles (15,000km), whichever is soonest.
- Inspection service<sup>3</sup> – First after 2 years or 20,000 miles (30,000km), then every 1 year or 20,000 miles (30,000km), whichever is soonest.



## SERVICING AND MAINTENANCE (CONTINUED)

### Flexible Service

The Flexible Service is recommended for vehicles with daily mileage of more than 25 miles where the vehicle is driven regularly mainly on longer distance journeys. The vehicle is driven mainly at a constant speed with minimum vehicle and engine loading, minimal towing and driven in an economical manner. With the Flexible Service the vehicle can cover anywhere between 10,000<sup>4</sup> and a maximum of 20,000<sup>4</sup> miles or 24 months (whichever is soonest) between oil changes.

The service intervals for the Flexible Service schedule are as follows:

- Oil change service – According to flexible service interval display (after 2 years at the latest).
- Inspection service<sup>3</sup> – First after 2 years or 20,000 miles (30,000km), then every one year or 20,000 miles (30,000km), whichever is soonest.

The up! model is only available with the Fixed Service schedule. Please consult your authorised Volkswagen retailer or repairer for advice and full details.

Please note: If you purchase a Volkswagen Fixed Price Service Plan your vehicle will follow the Fixed Service schedule.



## VOLKSWAGEN ENSURANCE<sup>5</sup>

Get three years' Volkswagen Insurance cover for free.

Another great benefit of being a Volkswagen driver. If your Volkswagen was damaged in an accident, wouldn't you want it fixed by a Volkswagen trained technician using only Genuine Volkswagen Parts? Insurance is Volkswagen's accident and repair cover which does exactly that. It works alongside your main comprehensive motor insurance policy no matter who you are insured with, to make sure you get the quality repair and service you would want. If you're involved in an accident or your car is stolen, just one call to us and we'll look after your claim from start to finish, ensuring your Volkswagen is restored to the highest standard.

Activate your cover and benefit from:

- A guarantee that your Volkswagen will be repaired by a Volkswagen approved repairer and Volkswagen trained technicians, using only Genuine Volkswagen Parts and paints.
- A dedicated Claims Manager who will manage your claim from start to finish, liaising with your insurer and the repairer so you don't have to.
- Help to recover any uninsured losses using our Legal Expenses Cover.
- Online claims tracking so you can keep up to date with the status of any claim.

Volkswagen Insurance is free to all Volkswagen customers for three years and it only takes a minute to get cover.

To find out more and to activate your cover, visit [www.insurewithvolkswagen.co.uk/insurance](http://www.insurewithvolkswagen.co.uk/insurance)

- 1 Finance is available to 18s and over, subject to status. Terms and conditions apply. Volkswagen Finance.
- 2 Volkswagen Car Insurance is underwritten by U K Insurance Limited. Registered Office: The Wharf, Neville Street, Leeds LS1 4AZ. Registered in England and Wales number: 1179980. U K Insurance Limited is authorised by the Prudential Regulation Authority and regulated by the Financial Conduct Authority (FCA) and the Prudential Regulation Authority. Calls may be recorded. Volkswagen Financial Services is a trading name of Volkswagen Financial Services (UK) Limited ('VWFS UK'), registered in England and Wales number: 2835230 (Registered Office: Brunswick Court, Yeomans Drive, Blakelands, Milton Keynes MK14 5LR). Volkswagen Insurance Service (Great Britain) Ltd. is an appointed representative of VWFS UK. VWFS UK is authorised and regulated by the FCA, registration number: 311988. Authorisation details for both organisations can be checked on the Financial Services Register by visiting [www.fca.org.uk](http://www.fca.org.uk). VWFS UK and U K Insurance Limited are not part of the same corporate group.
- 3 The inspection service first at 2 years (or 40,000 miles) and then every second year (or 40,000 miles) has additional workscope.
- 4 The quoted mileage is based on a conversion from kilometres and is therefore unlikely to exceed circa 18,000 miles between oil changes.
- 5 Insurance from Volkswagen Financial Services is sold and administered by Lawshield UK Limited, registered in England number: 3360532. Registered office: Lawshield House, 850 Ibis Court, Lakeside Drive, Centre Park, Warrington, Cheshire, WA1 1RL and underwritten by UK General Insurance Limited on behalf of Great Lakes Insurance SE. Great Lakes Insurance SE is a German insurance company with its headquarters at Königinstrasse 107, 80802 Munich. UK Branch office: Plantation Place, 30 Fenchurch Street, London, EC3M 3AJ. Lawshield UK Limited is authorised and regulated by the Financial Conduct Authority (FCA). Authorisation details can be checked on the FCA's register at [www.fca.org.uk](http://www.fca.org.uk). Great Lakes Insurance SE, UK Branch, is authorised by Bundesanstalt für Finanzdienstleistungsaufsicht and subject to limited regulation by the Financial Conduct Authority and Prudential Regulation Authority. Details about the extent of their regulation by the Financial Conduct Authority and Prudential Regulation Authority are available on request.

# Volkswagen service (continued).

## WARRANTY

Exclusions and terms and conditions apply to all warranties, plans and insurance listed. For pricing and further details of Volkswagen Warranties, Service Plans and Insurance, please consult your authorised Volkswagen retailer or repairer, or visit [www.volkswagen.co.uk](http://www.volkswagen.co.uk)

### THE VOLKSWAGEN WARRANTY THREE-YEAR WARRANTY

All Volkswagen passenger cars come with a three-year/60,000 miles warranty, which protects your car against the failure of most technical and electrical components due to manufacturing defects. This comprises a two-year manufacturer's warranty with unlimited mileage plus a further one-year/60,000 miles (whichever is soonest) Retailer Warranty<sup>1</sup>. Should the mileage exceed 60,000 miles within the first two years, the manufacturer's two-year warranty will still be valid. Full details of the three-year warranty are available from your authorised Volkswagen retailer or repairer.

### BODY PROTECTION WARRANTY

The internal body sections and panels are covered against rusting through from the inside for 12 years. Naturally, the vehicle must be cared for in compliance with the manufacturer's operating instructions. Please consult your authorised Volkswagen retailer or repairer for full warranty details.

### THREE-YEAR PAINTWORK WARRANTY

This latest paintwork warranty, pioneered by Volkswagen, provides you with cover on a new car. Naturally, during the warranty period the car must be cared for in compliance with the manufacturer's operating instructions. Any paintwork defects, as a result of the manufacturing process, will be rectified without charge.

### APPROVED ACCESSORIES

A comprehensive range of accessories from alloy wheels to carpet mats is available to complement the factory-fitted option list. Volkswagen approved accessories purchased from and fitted by your authorised Volkswagen retailer at the point of vehicle sale will also benefit from the three-year vehicle warranty.

## VOLKSWAGEN ROADSIDE ASSISTANCE

Every new car is registered for Volkswagen Roadside Assistance for one year except the Touareg which is registered for three years. This provides vehicle roadside and home recovery in the unlikely event of a breakdown in the UK and Europe (subject to conditions). Volkswagen Roadside Assistance can also be purchased for subsequent years.

Exclusions and terms and conditions apply. For pricing and further details of Volkswagen Roadside Assistance, please consult your authorised Volkswagen retailer, or visit [www.volkswagen.co.uk](http://www.volkswagen.co.uk)



## ADBLUE®

Diesel engines with SCR (Selective Catalytic Reduction) technology require AdBlue® which must be kept topped up. Please see [www.volkswagen.co.uk/technology/engines/adblue](http://www.volkswagen.co.uk/technology/engines/adblue) for more details.



## PRICES AND SPECIFICATIONS

The prices and specifications contained in this price list are for information purposes only as our products are continually updated and changes may be made to the prices and specifications at any time. If you require any specific feature, please consult your authorised Volkswagen retailer who is regularly updated with any change in specification. Prices and specifications are subject to change without notice.

Following the announcement of a price increase, any vehicle order which can be accepted into the factory production system before the effective date of the price increase will be supplied at the current price, even if built and delivered after the date on which the increase became effective.

*Note: We would like to advise you that telephone calls to Volkswagen Customer Care may be monitored and recorded as part of our training and quality assurance processes. All our monitoring and recording processes meet Ofcom regulations.*

## BENEFIT IN KIND (BIK) FOR SCOTTISH RESIDENTS

Effective as of 6 April 2018, the Scottish Government introduced their own BIK taxation structure. This is only applicable to Company Car Drivers that are resident Scottish taxpayers. HMRC will continue to be responsible for the collection and management of taxes and will determine whether or not an individual is a Scottish taxpayer based on where their primary place of residence is.

### Scottish Income Tax rates and Bands 2018/19

- Starter rate 19% over £11,850 - £13,850
- Basic rate of 20% over £13,850 - £24,000
- Intermediate rate 21% over £24,000 - £44,273
- Higher rate 41% over £44,273 - £150,000
- Top rate 46% above £150,000

## FUEL CONSUMPTION AND CO<sub>2</sub> EMISSIONS

Fuel consumption and CO<sub>2</sub> figures are obtained under standardised EU test conditions (Directive 93/116/EEC). This allows a direct comparison between different manufacturer models but may not represent the actual fuel consumption achieved in 'real world' driving conditions. More information is available on the Volkswagen website at [www.volkswagen.co.uk](http://www.volkswagen.co.uk) and at [www.dft.gov.uk/vca](http://www.dft.gov.uk/vca). The weight of a vehicle will influence the level of CO<sub>2</sub> emissions it produces; as a result, vehicles with higher levels of specification and factory-fitted options may emit higher levels of CO<sub>2</sub>. Choosing larger alloy wheels than those fitted as standard may result in increased fuel consumption as well as higher CO<sub>2</sub> emissions and subsequently an increased Vehicle Excise Duty (VED) band. BIK rates paid by company car drivers may also increase. In some instances, the recommended 'On the road' retail price paid for a vehicle may increase as a result of the increased VED rate. CO<sub>2</sub> is the main greenhouse gas responsible for global warming. The specifications contained in this brochure are for information purposes only and are subject to change.



<sup>1</sup> All warranty work must be completed by an authorised Volkswagen retailer or repairer.

# Volkswagen service plan.

An additional way to keep your perfect car, perfect for longer.

Exclusions and terms apply, [please click here](#) for more details. For pricing and further details of the Volkswagen Service Plan, please consult your authorised Volkswagen retailer or visit [www.volkswagen.co.uk](http://www.volkswagen.co.uk)

## Volkswagen Service Plan – retail sales only

We offer Volkswagen Service Plans to cover all new models for their first two consecutive services in line with the Fixed Service schedule required on the vehicle. Your car will be in the hands of Volkswagen trained technicians who use specialist Volkswagen tools, technology and Volkswagen original parts, and all parts and labour are guaranteed for two years. What's more, the Volkswagen Service Plan will remain with the vehicle should you decide to sell your car.

## Volkswagen Service Plan – retail sales only

For vehicles under 1 year old set to the Fixed Service regime that has not had its first service, comprising first two manufacturer's scheduled services:

- 'Oil service' including oil filter change
- 'Oil service' including oil filter change and 'Inspection service' plus a pollen filter replacement (if required)

Excludes electric vehicles. Service plan covers first two consecutive services, limited to 1x 'Oil service' and 1x 'Oil and Inspection service'. T&Cs apply: All vehicles must be set to the Fixed Service regime by the retailer. Maximum age of car is 12 months (Service plan must be taken out before first service is due). Additional work, including wear and tear is excluded. Servicing must be carried out in line with the requirement of the Service Schedule. All work must be carried out by an Authorised Volkswagen Repairer. Offers may be varied or withdrawn at any time. Plan validity is dependent on required payments received. Administered by Volkswagen Financial Services. Retail sales only. For pricing and further details, please consult your authorised Volkswagen retailer or visit [www.volkswagen.co.uk](http://www.volkswagen.co.uk)



Image shown is Sharan SEL with optional 18" 'Marseille' alloy wheels, Xenon dipped beam headlights and metallic paint.



# The Sharan

Issued by Volkswagen Marketing, Volkswagen (UK)  
© Volkswagen Group United Kingdom Limited 2020  
Issue: 1 April 2020

Volkswagen Information Service  
Telephone: 0800 333 666  
Internet: [www.volkswagen.co.uk](http://www.volkswagen.co.uk)

Volkswagen Fleet Business Centre  
Telephone: 0800 0093 397  
Internet: [www.volkswagen.co.uk/offers-and-finance/fleet](http://www.volkswagen.co.uk/offers-and-finance/fleet)

This brochure can be viewed or downloaded in pdf format at:  
[www.volkswagen.co.uk](http://www.volkswagen.co.uk)

*Prices, specifications, features, technical and other information (including fuel consumption, CO<sub>2</sub> emissions and range) are updated regularly and are subject to change without notice (this may include changes between order and delivery). There may be a delay in updates to our materials – always consult your authorised Volkswagen retailer for the latest information.*



[facebook.com/VolkswagenUK](https://facebook.com/VolkswagenUK)



[@UKVolkswagen](https://twitter.com/@UKVolkswagen)



[youtube.com/user/ukvolkswagen](https://youtube.com/user/ukvolkswagen)



[volkswagen\\_uk](https://volkswagen_uk)