



# MAZDA CX-80

PRICES & SPECIFICATIONS



## THE MAZDA CX-80

The Mazda CX-80 is our latest and most spacious three-row SUV, offering seating for up to seven passengers. Roomy and versatile, every element has been carefully crafted to make the most out of the interior cabin using the Japanese philosophy of 'Ma', which uses the beauty of empty space to create a sense of calm, ensuring a peaceful and relaxing journey.

When designing the exterior, our vision was to create a car that had 'Graceful Toughness', providing a modern, stylish design that provides a purposeful presence on the road. We did this by utilising our award winning Kodo - Soul of Motion design language, which reflects the beauty of the vehicle's surroundings.

On the road, it comes equipped with the latest in engine technology that delivers an unrivalled driving experience. Powered by a selection of engines that offer the perfect balance of performance and efficiency, you'll love the highly responsive driving dynamics and the reassurance of our i-ACTIV all-wheel drive system every time you hit the road – no matter the road conditions.



CRAFTED WITH JAPANESE SOUL

## THE LATEST IN TECHNOLOGY & CONVENIENCE

### MAZDA CONNECT

#### The latest in-car infotainment

Mazda Connect allows for seamless connectivity between you and your Mazda. Information is displayed on a beautiful & clear central 12.3" screen which is perfectly positioned at eye level.

Access vehicle information and settings, entertainment options including DAB Radio, connect your smartphone via Bluetooth to make and receive calls, access your contacts, and utilise the European wide Navigation system which comes with 7-years free map updates.

The Mazda CX-80 also features Amazon Alexa in-car voice control. Simply talk to Alexa to play music, check the weather, set a destination, control the air-conditioning and more, whilst keeping both hands on the wheel.



### WIRELESS APPLE CARPLAY® & ANDROID AUTO™

#### Smarter, safer way to use your smartphone

With wireless Apple CarPlay®, get easy access to Apple Music, Maps, Messages and make phone calls with Siri through the car's Multimedia Commander and touchscreen.

Wireless Android Auto™ also allows you to access your favourite music and messaging apps, Google Maps and YouTube Music. Google Assistant voice control helps you send and receive messages, make calls, get directions and plan your day while you keep your eyes safely on the road.

## THE LATEST IN TECHNOLOGY & CONVENIENCE

### MAZDA Mi-DRIVE

#### Intelligent Drive Select System

Mi-DRIVE is a system that switches driving modes depending on the road and vehicle conditions. Featured on all grades, Sport mode enhances vehicle responsiveness when the accelerator pedal is pressed.

For rough terrain and slippery road conditions, Off-Road mode prevents the driven wheels from spinning when driving, improving road-holding performance. Towing mode optimises driving performance due to increased weight when towing a trailer, refining vehicle stability. PHEV models also benefit from EV mode which allows you to drive the vehicle utilising the electrical motor, cutting down on fuel usage and emissions.



### MYMAZDA APP CONNECTIVITY

#### Controls at your fingertips

The Mazda CX-80 can share vehicle information with the MyMazda app via Connected Services. This provides several features which enhances the connection between you and your Mazda.

In addition, the Mazda CX-80 PHEV has the ability to not only monitor and control your charging, but also has the ability to heat or cool the cabin prior to your departure, as well as control the front and rear defrost function on those frosty mornings.

Further information on these features and more can be found at [www.mazda.co.uk/owners/connectivity/](http://www.mazda.co.uk/owners/connectivity/)

## THE LATEST IN TECHNOLOGY & CONVENIENCE

### 12.3" COLOUR ACTIVE DRIVING DISPLAY

#### Key information within your eyeline

Fitted as standard, the 12.3" colour Active Driving Display is a technology feature that projects key information directly onto the windscreen within the driver's line of sight.

Information includes vehicle speed, cruise control settings and will provide satellite navigation directions in relation to the Mazda Navigation System.



### 12.3" DIGITAL INSTRUMENT CLUSTER

#### Immerse yourself in the drive

Working in harmony with the Mi-DRIVE system, the digital instrument cluster provides individual driving displays for each driving mode. This ensures that the instrument cluster displays the most important information, which in combination with the 12.3" Active Driving Display (Head-up display) contributes to a safer driving environment, as well as helping the driver to immerse themselves more in the drive.

## THE LATEST IN TECHNOLOGY & CONVENIENCE

### BOSE PREMIUM SOUND SYSTEM

#### Made to move you

The high-performance speakers make you feel like you're at the front row of your favourite concert, making you feel immersed in whatever you're listening to.

The premium sound system includes all the latest Bose technologies such as CenterPoint, BassMatch and AudioPilot which all contribute to an immersive entertainment experience.

(Not available on Exclusive-Line grades)



### MULTIMEDIA COMMANDER

#### Easy to use, driver centric, eyes on the road

The Multimedia Commander provides simple and easy access to the Mazda Connect infotainment system. The tactile feel plays to the senses allowing for ease of use whilst on the move, and more importantly, allows you to keep your eyes on the road.

## A SENSE OF LUXURY

The Mazda CX-80 is our largest SUV to date, providing ample cabin space for you and your passengers. The second row of seats offer tilt and slide functions to help your passengers relax in comfort ensuring that they will end the journey feeling refreshed, whilst the third row offers generous amounts of space when carrying passengers and can be folded down with ease to utilise cargo space.

For those who want to enhance the level of comfort for their passengers, Homura and Homura Plus grades offer the option of two Captain's Chairs to accommodate the second row, allowing both passengers to adjust to their own individual seating position with comfortable and adjustable armrests.

The option on Takumi Plus grades further enhance levels of comfort, with the addition of seating ventilation to the two middle row Captain's Chairs as well as the addition of a centre console featuring an armrest, additional storage and cupholders.



## WEEKEND AWAY, PACK YOUR BAGS

Pack your bags and essentials for a long-distance adventure, the Mazda CX-80 proves to be the perfect travel companion. Rear passengers enjoy the convenience of their own USB-C charging ports for their devices, while the third row of seats folded down reveals a spacious luggage capacity of up to 687 litres. Additionally, PHEV models offer a 1500w AC socket in the rear, ideal for powering a portable cooler or charging an electric bike.

Accessing the ample boot space is effortless and hassle-free thanks to the hands-free power liftgate. With just a simple swipe of your foot beneath the rear bumper, the tailgate automatically lifts, providing easy access to your belongings.

## SPACIOUS AND FLEXIBLE

As our most spacious SUV, the Mazda CX-80 can accommodate up to 7 passengers with ease. Passengers can access the third row of seating via a large wide rear door opening, whilst a large step and grab handle help passengers to climb aboard. Access is enhanced with our one-touch walk-in feature\* which automatically moves the second-row seat bench for optimal access.

When you need to carry larger items, both the second and third row of seats fold down providing up to 1,971 litres of cargo space making the Mazda CX-80 suited to any adventure.

## 7-SEAT VERSATILITY



## 6-SEAT VERSATILITY



\*One-touch walk-in feature available as part of the Comfort Pack on Exclusive-Line models. Not available on 6-seat configurations

## BUILT TO TOW UP TO 2,500KG

Mazda believe in the 'right-sized' approach to engine capacity. By increasing the engine's size of both our PHEV and Diesel powertrains, we create a larger combustion chamber that allows for a more powerful and efficient combustion process. The result? Lower emissions, exceptional fuel economy, and a surge of torque that provides you with the ability to tow up to 2,500kg.

It's the perfect combination of performance and sustainability – engineered to give you an exhilarating and unforgettable driving experience!



## ADDED REASSURANCE

The PHEV provides up to 500Nm of torque whilst the Diesel offers up to 550Nm. All Mazda CX-80's feature our i-ACTIV AWD system which provides increased torque to the rear wheels, improving stability on Motorways and unpaved roads, whilst the Dynamic Stability Control enhances traction through rough terrain.

Stability is the most important quality you can look for in a tow car, which is why both our Trailer Stability Control, and our Mi-DRIVE Intelligent Drive Select System (which provides a bespoke Towing mode<sup>^</sup>), are designed to increase the stability of the vehicle during towing. Helping to suppress any potential swaying and providing a smooth and confident drive.

<sup>^</sup>Activates once you equip your Mazda CX-80 with an approved Mazda Tow Bar.

## TRAILER HITCH VIEW

### Confidence when hitching independently

Connecting your trailer or caravan has never been easier. Grades equipped with the 360° View Monitor gain Trailer Hitch View<sup>^</sup> which enhances the coupling experience by combining a live rear-view image of the vehicle with a selectable Trailer Hitch Guideline on the centre infotainment display.

This feature simplifies alignment when reversing your vehicle by providing a clear view and guidelines to help make it easier to hitch a trailer independently with precision and confidence.

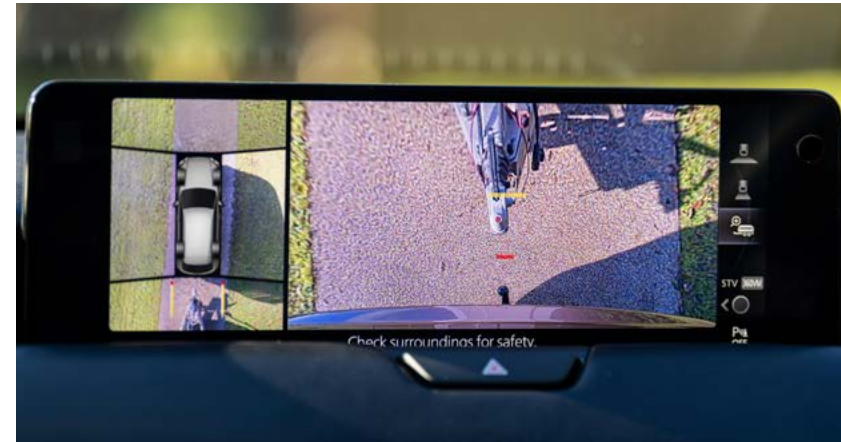

## DON'T HOLD BACK

The Mazda CX-80 is designed to help people spend more time in the great outdoors. An active outdoor lifestyle often means bringing along plenty of equipment, and the Mazda CX-80 has the space to fill. With a large and flexible interior that's adaptable enough to fit everything from family camping equipment to skis.

Also available\* is the 150W AC socket in the luggage compartment, giving you the convenience of a UK 3-PIN socket to power up your essential accessories - whether it's a mini fridge, LED lights, camera battery chargers, or portable fans. For those looking at even more power, the PHEV models add an additional 1500W AC socket, perfect for larger devices like TV's, electric bike chargers, coffee makers, or even hair dryers! It's all about making your journey as comfortable and convenient as possible.

<sup>^</sup>Activates once you equip your Mazda CX-80 with an approved Mazda Tow Bar.  
\*As part of the Convenience and Driver Assistance pack, or as standard on Homura Plus and Takumi Plus grades. Always check manufacturers appliance instructions before using.

## EXCLUSIVE-LINE



Mazda CX-80 Exclusive-Line in Rhodium White

## Recommended on the road\* from £50,085



18" Grey alloy wheels



Black leather seat trim^



Windscreen projected colour Active Driving Display



12.3-inch TFT colour centre display

## STANDARD FEATURES

### EXTERIOR

- 18" Grey alloy wheels
- Body coloured electrically adjustable, heated, auto power-folding door mirrors
- Front and rear parking sensors
- Front grille in Gloss Black (bar type) with Bright finish Signature Wing
- Front rain-sensing wipers
- Front wiper de-icer
- LED headlights with auto levelling
- Coming home/leaving home lights
- Dusk-sensing headlights
- LED daytime running lights
- High Beam Control
- Handsfree power liftgate
- Reversing camera
- Roof rails
- Wheel arch and side sill mouldings in Satin Black

### INTERIOR

- Black leather seat trim^
- Colour 12.3" TFT instrument cluster display (provides speed, traffic signs and cruise control information)
- Frameless auto-dimming rear-view mirror
- Heated leather-wrapped steering wheel
- Grey roof lining
- Seats (front)
  - Driver seat manual tilt, slide, recline and height adjustment
  - Passenger seat manual slide, recline and height adjustment
  - Heated with 3-stage setting
- Seats (second row)
  - 60:40 split fold down rear seats (3-seat bench only)
  - Manual slide & recline
  - 3-seat bench featuring folding centre armrest equipped w/2 cup holders
- Seats (third row)
  - 2-seat bench
  - 50:50 split fold down rear seats

### SAFETY & SECURITY

- Blind Spot Monitoring with Rear Cross Traffic Alert and vehicle exit warning
- Driver Monitoring
- e-Call with GPS
- Emergency Lane-Keeping with:
  - Road Keep Assist
  - Blind Spot Assist
  - Oncoming vehicle collision avoidance assist
- Front Cross Traffic Alert
- Hill Descent Control
- Lane-keep Assist System with Lane Departure Warning System
- Smart Brake Support - Front and Rear
- Smart keyless entry
- Traffic Sign Recognition

### CHARGING (PHEV ONLY)

- AC Charging cable for home and public fast chargers
- AC Charging cable for UK 3-pin plug socket

### COMFORT & CONVENIENCE

- Cruise Control with Adjustable Speed Limiter
- Integrated sunshade for 2nd row
- Mi-DRIVE: drive mode selection
- Three-zone climate control air-conditioning with rear air-vents
- Windscreen Projected colour Active Driving Display (Head-up Display)

### INFOTAINMENT

- AM / FM / DAB radio, with 8 speakers and USB-C inputs
- Amazon Alexa car integration
- Connected Services~
- Integrated Bluetooth®
- Mazda Connect multimedia system with 12.3" Colour centre display and Multimedia Commander
- Mazda Navigation System with European mapping and 7-years free map updates
- Wireless Apple CarPlay® & Android Auto™

^Leather refers to centre seat facing and side supports. ~Connected Services is a subscription service and requires a compatible mobile device to download and sign-up to the MyMazda App. A 7-year complimentary period is included and commences from the date of first registration of the vehicle. Please contact your dealer or visit [www.mazda.co.uk/my-mazda](http://www.mazda.co.uk/my-mazda) for further information.

\*Recommended OTR price includes VAT, number plates, delivery to the dealer, 12 months' Vehicle Excise Duty (VED), first registration fee, 6-year or 100,000 mile warranty and 3 years' European roadside assistance. Pricing and specification are subject to change. Please speak with your local dealer for latest pricing information.

# HOMURA



Mazda CX-80 Homura in Soul Red Crystal

Recommended on the road\* from £53,235



20" Black alloy wheels



Black Nappa leather seat trim^



Gloss Black wing mirrors



12 Bose speaker surround-sound system

## STANDARD FEATURES - in addition to Exclusive-Line, Homura adds:

### EXTERIOR

- 20" Black alloy wheels
- Front grille in Gloss Black (honeycomb type) with Dark plated finish Signature Wing
- Gloss black wing mirrors with memory and selectable tilt-down function when in reverse
- Wheel arch and side sill mouldings - body coloured

### INTERIOR

- Black roof lining
- Black Nappa leather seat trim^
- Seats (front)
  - Driver and front passenger seat electric tilt, slide, recline, height and lumbar adjustment
  - Mazda Driver Personalisation System
  - Driver seat ingress/ Egress support & automatic driver position guide
  - Ventilation with 3-stage setting
- Seats (second row)
  - Heated outer rear seats with 3-stage setting
  - One-touch walk-in (3-seat bench only)
- Electric steering wheel adjustment

### COMFORT & CONVENIENCE

- Ambient lighting

### INFOTAINMENT

- 12 Bose speaker surround-sound system featuring Bose Centerpoint signal processing and AudioPilot 2 noise compensation technology

### OPTIONAL SEATING CONFIGURATION

- Captain's Chairs (6-seat configuration)
  - Second row of 2 heated Captain's Chairs (in lieu of 3 seat bench) with centre walkthrough

^Leather refers to centre seat facing and side supports.

\*Recommended OTR price includes VAT, number plates, delivery to the dealer, 12 months' Vehicle Excise Duty (VED), first registration fee, 6-year or 100,000 mile warranty and 3 years' European roadside assistance. Pricing and specification are subject to change. Please speak with your local dealer for latest pricing information.

# HOMURA PLUS



Mazda CX-80 Homura Plus in Machine Grey

## STANDARD FEATURES - in addition to Homura, Homura Plus adds:

### EXTERIOR

- 360° View Monitor with see through view and trailer connection support view
- Adaptive LED Headlights
- Panoramic sunroof
- Rear privacy glass

### INTERIOR

- Door pocket illumination and front & rear door courtesy lamps
- Electrical power outlet
  - 150W AC socket
  - 1500W AC socket (PHEV models only)
- Front centre storage illumination

## Recommended on the road\* from £55,885

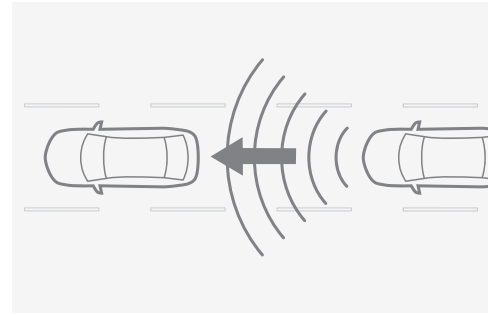

Mazda Radar Cruise Control



Panoramic Sunroof

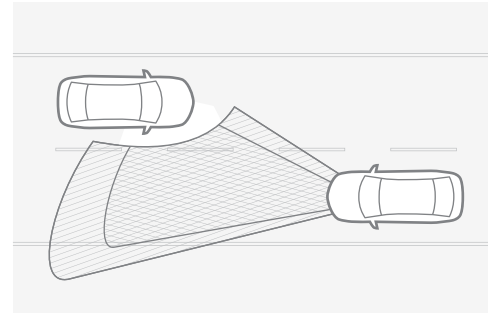

Adaptive LED Headlights

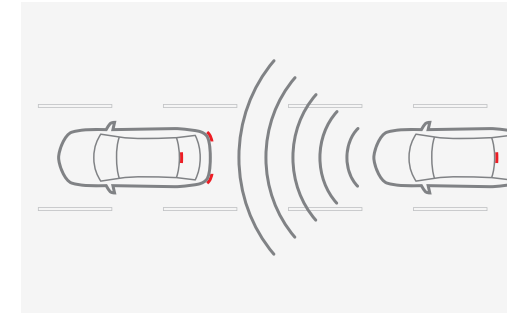

Cruising & Traffic Support

### COMFORT & CONVENIENCE

- Cruising & Traffic Support (CTS)
- Mazda Radar Cruise Control (MRCC) (Features Stop & Go function)

### INFOTAINMENT

- Qi Wireless Charging

### OPTIONAL SEATING CONFIGURATION

- Captain's Chairs (6-seat configuration)
  - Second row of 2 heated Captain's Chairs (in lieu of 3 seat bench) with centre walkthrough

\*Recommended OTR price includes VAT, number plates, delivery to the dealer, 12 months' Vehicle Excise Duty (VED), first registration fee, 6-year or 100,000 mile warranty and 3 years' European roadside assistance. Pricing and specification are subject to change. Please speak with your local dealer for latest pricing information.

# TAKUMI



Mazda CX-80 Takumi in Melting Copper

Recommended on the road\* from £54,185



20" Grey Diamond Cut alloy wheels



White Nappa Leather seat trim^



White Maple wood



Leather wrapped steering wheel with white stitching

## STANDARD FEATURES - in addition to Exclusive-Line, Takumi adds:

### EXTERIOR

- 20" Grey Diamond Cut alloy wheels
- Body coloured wing mirrors with memory and selectable tilt-down function when in reverse
- Wheel arch and side sill mouldings - body coloured

### INTERIOR

- Seats (front)
  - Driver and front passenger seat electric tilt, slide, recline, height and lumbar adjustment
  - Mazda Driver Personalisation System
  - Driver seat ingress/ Egress support & automatic driver position guide
  - Ventilation with 3-stage setting
- Seats (second row)
  - Heated outer rear seats with 3-stage setting
  - One-touch walk-in (3-seat bench only)
- Electric steering wheel adjustment
- Leather wrapped steering wheel with white stitching
- White Maple wood interior accents
- White Nappa leather seat trim^

### COMFORT & CONVENIENCE

- Ambient lighting

### INTERIOR

- 12 Bose speaker surround-sound system featuring Bose Centerpoint signal processing and AudioPilot 2 noise compensation technology

^Leather refers to centre seat facing and side supports. \*Recommended OTR price includes VAT, number plates, delivery to the dealer, 12 months' Vehicle Excise Duty (VED), first registration fee, 6-year or 100,000 mile warranty and 3 years' European roadside assistance. Pricing and specification are subject to change. Please speak with your local dealer for latest pricing information.

# TAKUMI PLUS



Mazda CX-80 Takumi Plus in Artisan Red

## STANDARD FEATURES - in addition to Takumi, Takumi Plus adds:

### EXTERIOR

- 360° View Monitor with see through view and trailer connection support view
- Adaptive LED Headlights
- Panoramic sunroof
- Rear privacy glass

### INTERIOR

- Door pocket illumination and front & rear door courtesy lamps
- Electrical power outlet
  - 150W AC socket
  - 1500W AC socket (PHEV models only)
- Front centre storage illumination

## Recommended on the road\* from £56,835

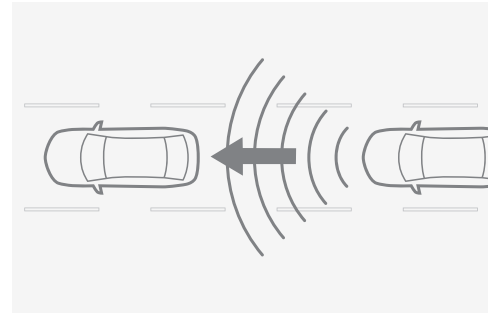

Mazda Radar Cruise Control



Panoramic Sunroof



360° View Monitor with see through view

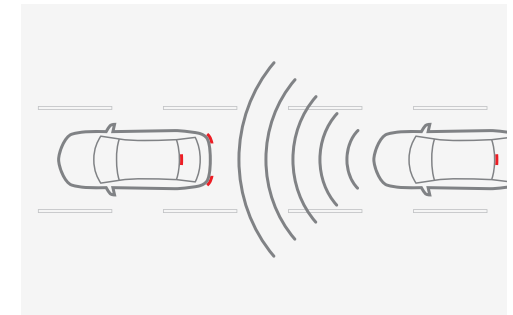

Cruising & Traffic Support

### COMFORT & CONVENIENCE

- Cruising & Traffic Support
- Mazda Radar Cruise Control (Features Stop & Go function)

### INFOTAINMENT

- Qi Wireless Charging

### OPTIONAL SEATING CONFIGURATION

- Captain's Chairs (6-seat configuration)
  - Second row of 2 heated & ventilated Captain's Chairs (in lieu of 3 seat bench) with centre console featuring armrest, additional storage and cupholders.

\*Recommended OTR price includes VAT, number plates, delivery to the dealer, 12 months' Vehicle Excise Duty (VED), first registration fee, 6-year or 100,000 mile warranty and 3 years' European roadside assistance. Pricing and specification are subject to change. Please speak with your local dealer for latest pricing information.

# OPTION PACKS

## COMFORT PACK

£1,400

Optional on Exclusive-Line

- 20" Silver alloy wheels
- Door mirror memory
- Driver and front passenger electric slide, recline, height and lumbar adjustment
- Front seat ventilation
- One-touch fold down rear seats (2nd row)
- Heated outer rear seats (2nd row)
- Mazda Driver Personalisation System: (excludes steering wheel function & Ingress/ Egress support)

## PANORAMIC SUNROOF

£1,000

Optional on Homura, & Takumi (Standard on Homura Plus & Takumi Plus)

- Electrically operated tilt & slide

## CAPTAINS SEAT (6-SEAT CONFIGURATION)

NO COST OPTION

Optional on Homura & Homura Plus

- 2nd row seat - Captain seat (2 seats)
- 2nd row with seat split (40:40), with walk through to 3<sup>rd</sup> row seat

## CAPTAINS SEAT (6-SEAT CONFIGURATION)

£750

Optional on Takumi Plus

- 2nd row seat - Captain seat (2 seats) with seat ventilation
- 2nd row with seat split (40:40), Center console with armrest, additional storage and cupholders

## CONVENIENCE & DRIVER ASSISTANCE PACK (PHEV models only): £1,950

Optional on Exclusive-Line, Homura, & Takumi  
(Standard on Homura Plus & Takumi Plus)

- 360° View Monitor with see through view & trailer connection support
- Qi Wireless Charging
- 1500W AC socket (PHEV models only)
- 150W AC socket
- Front centre storage with illumination
- Door pocket illumination with front & rear door courtesy lamps
- Rear privacy glass
- Mazda Radar Cruise Control
- Cruising & Traffic Support
- Intelligent Speed Assistance
- Adaptive LED Headlights

## CONVENIENCE & DRIVER ASSISTANCE PACK (Diesel models only): £1,750

Optional on Exclusive-Line, Homura, & Takumi  
(Standard on Homura Plus & Takumi Plus)

- 360° View Monitor with see through view & trailer connection support
- Qi Wireless Charging
- 150W AC socket
- Front centre storage with illumination
- Door pocket illumination with front & rear door courtesy lamps
- Rear privacy glass
- Mazda Radar Cruise Control
- Cruising & Traffic Support
- Intelligent Speed Assistance
- Adaptive LED Headlights

# PRICING

e-SKYACTIV PHEV	PRICE	VAT	P11D VALUE <sup>1</sup>	FIRST YEAR VED & DVLA FIRST REG FEE <sup>2</sup>	RECOMMENDED ON THE ROAD <sup>3</sup>	CO <sub>2</sub> EMISSIONS COMBINED (g/km) <sup>4</sup>	BIK TAX (%) <sup>5</sup>	2026/27 MONTHLY TAX LIABILITY 20%/40%	INSURANCE GROUP
Mazda CX-80 2.5 327ps AWD Exclusive-Line Auto	£41,595.83	£8,319.17	£49,915	£170	£50,085	35 - 38	14%	£116/£233	37A
Mazda CX-80 2.5 327ps AWD Homura Auto	£44,220.83	£8,844.17	£53,065	£170	£53,235	35 - 38	14%	£124/£248	38A
Mazda CX-80 2.5 327ps AWD Homura Plus Auto	£46,429.17	£9,285.83	£55,715	£170	£55,885	36 - 38	14%	£130/£260	39A
Mazda CX-80 2.5 327ps AWD Takumi Auto	£45,012.50	£9,002.50	£54,015	£170	£54,185	35 - 38	14%	£126/£252	38A
Mazda CX-80 2.5 327ps AWD Takumi Plus Auto	£47,220.83	£9,444.17	£56,665	£170	£56,835	35 - 38	14%	£132/£264	39A

1 - Petrol/diesel/alternative fuel cars with a list price of over £40,000 (including VAT, paint, and factory fitted options) at first registration, the customer will have to pay an additional VED charge (currently £440) for five years from the start of the second licence (in addition to the standard VED charge per year, currently £200 for all vehicles).

2 - First year rate Vehicle Excise Duty as of 1 April 2026, includes £55 DVLA first registration fee.

3 - Recommended OTR price includes VAT, number plates, delivery to the dealer, 12 months' Vehicle Excise Duty (VED), first registration fee, 6-year or 100,000 mile warranty and 3 years' European roadside assistance.

4 - Figures shown are for comparability purposes. Only compare CO<sub>2</sub> figures with other cars tested to the same technical procedures. These figures may not reflect real life driving results, which will depend upon a number of factors including the accessories fitted (post registration), variations in weather, driving styles and vehicle load. All figures quoted are derived from the latest WLTP test cycle.

5 - BIK tax figures quoted per month in 2026/27 (except Scotland).

Pricing and specifications are subject to change. Please speak with your local dealer for latest pricing information.

## FACTORY FITTED OPTIONS

	BASIC PRICE	VAT	MSRP
Comfort Pack <sup>1)</sup> : - 20" Silver alloy wheels - Door mirror memory - Driver and front passenger electric slide, recline, height and lumbar adjustment - Front seat ventilation - One-touch fold down rear seats (2nd row) - Heated outer rear seats (2nd row) - Mazda Driver Personalisation System: (excludes steering wheel function & Ingress/ Egress support)	£1,166.67	£233.33	£1,400
Convenience & Driver Assistance Pack (PHEV models only) <sup>2)</sup> : - 360° View Monitor with see through view & trailer connection support - Qi Wireless Charging - 1500W AC socket (PHEV models only) - 150W AC socket - Front centre storage with illumination - Door pocket illumination with front & rear door courtesy lamps - Rear privacy glass - Mazda Radar Cruise Control - Cruising & Traffic Support - Intelligent Speed Assistance - Adaptive LED Headlights	£1,625.00	£325.00	£1,950
Homura/Homura Plus - Captains Chairs (6-seat configuration) Second row of 2 heated Captains Chairs (in lieu of 3 seat bench) with centre walkthrough	£0.00	£0.00	£0
Takumi Plus - Captains Chairs (6-seat configuration) Second row of 2 heated and ventilated Captains Chairs (in lieu of 3 seat bench) with centre console	£625.00	£125.00	£750
Panoramic sunroof <sup>3)</sup>	£833.33	£166.67	£1,000

<sup>1)</sup> Optional on Exclusive-Line models only.

<sup>2)</sup> Standard on Homura Plus and Takumi Plus grades.

<sup>3)</sup> Optional on Homura & Takumi grades. Standard on Homura Plus and Takumi Plus grades.

# PRICING

e-SKYACTIV D MHEV	PRICE	VAT	P11D VALUE <sup>1</sup>	FIRST YEAR VED & DVLA FIRST REG FEE <sup>2</sup>	RECOMMENDED ON THE ROAD <sup>3</sup>	CO <sub>2</sub> EMISSIONS COMBINED (g/km) <sup>4</sup>	BIK TAX (%) <sup>5</sup>	2026/27 MONTHLY TAX LIABILITY 20%/40%	INSURANCE GROUP
Mazda CX-80 3.3D 254ps AWD Exclusive-Line Auto	£43,483.33	£8,696.67	£52,180	£615	£52,795	148	35%	£304/£609	37A
Mazda CX-80 3.3D 254ps AWD Homura Auto	£46,108.33	£9,221.67	£55,330	£615	£55,945	149	35%	£323/£646	38A
Mazda CX-80 3.3D 254ps AWD Homura Plus Auto	£48,150.00	£9,630.00	£57,780	£1,465	£59,245	151	36%	£347/£693	39A
Mazda CX-80 3.3D 254ps AWD Takumi Auto	£46,900.00	£9,380.00	£56,280	£615	£56,895	149	35%	£328/£657	38A
Mazda CX-80 3.3D 254ps AWD Takumi Plus Auto	£48,941.67	£9,788.33	£58,730	£1,465	£60,195	151	36%	£352/£705	39A

1 - Petrol/diesel/alternative fuel cars with a list price of over £40,000 (including VAT, paint, and factory fitted options) at first registration, the customer will have to pay an additional VED charge (currently £440) for five years from the start of the second licence (in addition to the standard VED charge per year, currently £200 for all vehicles).

2 - First year rate Vehicle Excise Duty as of 1 April 2026, includes £55 DVLA first registration fee.

3 - Recommended OTR price includes VAT, number plates, delivery to the dealer, 12 months' Vehicle Excise Duty (VED), first registration fee, 6-year or 100,000 mile warranty and 3 years' European roadside assistance.

4 - Figures shown are for comparability purposes. Only compare CO<sub>2</sub> figures with other cars tested to the same technical procedures. These figures may not reflect real life driving results, which will depend upon a number of factors including the accessories fitted (post registration), variations in weather, driving styles and vehicle load. All figures quoted are derived from the latest WLTP test cycle.

5 - BIK tax figures quoted per month in 2026/27 (except Scotland).

Pricing and specifications are subject to change. Please speak with your local dealer for latest pricing information.

## FACTORY FITTED OPTIONS

Factory fitted option prices are added to the P11D Value of the vehicle. Please note, on-the-road pricing for these options may vary due to the inclusion of the UK Governments First Year Rates of VED which vary according to the carbon dioxide (CO<sub>2</sub>) emissions of the vehicle. For confirmation of specific grade CO<sub>2</sub> emissions, please refer to [www.mazda.co.uk/configurator](http://www.mazda.co.uk/configurator) or your preferred Mazda dealer.

	BASIC PRICE	VAT	MSRP
<b>Comfort Pack<sup>1)</sup>:</b> - 20" Silver alloy wheels - Door mirror memory - Driver and front passenger electric slide, recline, height and lumbar adjustment - Front seat ventilation - One-touch fold down rear seats (2nd row) - Heated outer rear seats (2nd row) - Mazda Driver Personalisation System: (excludes steering wheel function & Ingress/ Egress support)	£1,166.67	£233.33	£1,400
<b>Convenience &amp; Driver Assistance Pack (Diesel models only)<sup>2)</sup>:</b> - 360° View Monitor with see through view & trailer connection support - Qi Wireless Charging - 150W AC socket - Front centre storage with illumination - Door pocket illumination with front & rear door courtesy lamps - Rear privacy glass - Mazda Radar Cruise Control - Cruising & Traffic Support - Intelligent Speed Assistance - Adaptive LED Headlights	£1,458.33	£291.67	£1,750
Homura/Homura Plus - Captains Chairs (6-seat configuration) Second row of 2 heated Captains Chairs (in lieu of 3 seat bench) with centre walkthrough	£0.00	£0.00	£0
Takumi Plus - Captains Chairs (6-seat configuration) Second row of 2 heated and ventilated Captains Chairs (in lieu of 3 seat bench) with centre console	£625.00	£125.00	£750
Panoramic sunroof <sup>3)</sup>	£833.33	£166.67	£1,000

<sup>1)</sup> Optional on Exclusive-Line models only.

<sup>2)</sup> Standard on Homura Plus and Takumi Plus grades.

<sup>3)</sup> Optional on Homura & Takumi grades. Standard on Homura Plus and Takumi Plus grades.

## PAINT FINISH OPTIONS



ARCTIC WHITE | £0



PLATINUM QUARTZ | £700



MELTING COPPER | £700



DEEP CRYSTAL BLUE | £700



JET BLACK | £700



RHODIUM WHITE | £800



MACHINE GREY | £800



ARTISAN RED | £1,000



SOUL RED CRYSTAL | £1,000

Use our car configurator to find the perfect Mazda CX-80 for you.



[BUILD YOUR MAZDA CX-80](#)

## MAZDA CX-80 INTERIOR TRIMS AND COLOURATION



Black leather seat trim<sup>^</sup>  
(EXCLUSIVE-LINE)



Black Nappa Leather seat trim<sup>^</sup>  
(HOMURA AND HOMURA PLUS)



White Nappa Leather seat trim<sup>^</sup>  
(TAKUMI AND TAKUMI PLUS)

## MAZDA CX-80 ALLOY WHEELS



18" Grey alloy wheels  
(EXCLUSIVE-LINE)



20" Silver alloy wheels  
(OPTIONAL ON EXCLUSIVE-LINE  
AS PART OF THE COMFORT PACK)



20" Black alloy wheels  
(HOMURA AND HOMURA PLUS)



20" Grey Diamond Cut alloy wheels  
(TAKUMI AND TAKUMI PLUS)

## OPTIONS & ACCESSORIES



ROOF BARS - **£366.65**

With Ski & Snowboard attachment - **£526.39**

With Pro Bicycle roof bar attachment - **£508.90**



TRUNK NET

**£58.72**



COLOUR CODED KEY FOB COVER

From **£69.13**



ROOF BOX

**£529.99**



ILLUMINATED SCUFF PLATES

**£465.90**

Options & Accessories: A small selection of our range of accessories are shown within this Price and Specification guide. For more information on the entire range of accessories we retail, please visit [www.mazda.co.uk/configurator](http://www.mazda.co.uk/configurator), select your vehicle and visit the 'Options & Accessories' section. The price shown is a non-binding recommendation of Mazda Motors UK, is subject to change and may not include extras such as painting. Alloy wheel prices do not include tyres. Accessory fitment costs may differ between Mazda dealers. For further information about Mazda Genuine Accessories and latest pricing including any fitment cost differences please contact your local Mazda dealer.

## OPTIONS & ACCESSORIES



THULE BICYCLE CARRIER - TWO BIKE  
£628.62



CARGO BLOCKS (SET OF 2)  
£46.64



GLOSS BLACK DOOR MIRROR COVERS  
£233.38



RETRACTABLE TOW BAR (not including 13 pin tow bar harness)  
PHEV - £1501.69  
Diesel - £1459.20



COAT HANGER  
£34.21



ALL WEATHER TRUNK LINER (3rd row seats folded)  
£123.00

Options & Accessories: A small selection of our range of accessories are shown within this Price and Specification guide. For more information on the entire range of accessories we retail, please visit [www.mazda.co.uk/configurator](http://www.mazda.co.uk/configurator), select your vehicle and visit the 'Options & Accessories' section. The price shown is a non-binding recommendation of Mazda Motors UK, is subject to change and may not include extras such as painting. Alloy wheel prices do not include tyres. Accessory fitment costs may differ between Mazda dealers. For further information about Mazda Genuine Accessories and latest pricing including any fitment cost differences please contact your local Mazda dealer.

## OPTIONS & ACCESSORIES



**BOOT MAT WITH REAR BUMPER PROTECTION**

3rd row seats folded down - **£123.00**

3rd row seats upright - **£63.00**



**DOOR POCKET LINERS (10 pcs)**

**£47.63**



**BOOT ORGANISER**

**£85.08**



**LUXURY VELOUR FLOOR MATS  
(1ST & 2ND ROW)**

**£113.00**

**3RD ROW LUXURY VELOUR FLOOR MATS**

7 seat configuration - **£161.00**

6 seat (Homura & Homura Plus) - **£166.00**

6 seat (Takumi Plus) - **£166.00**



**ALL WEATHER FLOOR MATS  
(1ST & 2ND ROW)**

**£123.00**

**3RD ROW ALL WEATHER FLOOR MATS**

7 seat configuration - **£186.00**

6 seat (Homura & Homura Plus) - **£245.00**

6 seat (Takumi Plus) - **£225.00**

Options & Accessories: A small selection of our range of accessories are shown within this Price and Specification guide. For more information on the entire range of accessories we retail, please visit [www.mazda.co.uk/configurator](http://www.mazda.co.uk/configurator), select your vehicle and visit the 'Options & Accessories' section. The price shown is a non-binding recommendation of Mazda Motors UK, is subject to change and may not include extras such as painting. Alloy wheel prices do not include tyres. Accessory fitment costs may differ between Mazda dealers. For further information about Mazda Genuine Accessories and latest pricing including any fitment cost differences please contact your local Mazda dealer.

# EQUIPMENT

		EXCLUSIVE-LINE	HOMURA	HOMURA PLUS	TAKUMI	TAKUMI PLUS
<b>EXTERIOR</b>						
B-Pillar and C-Pillar garnish	Gloss Black	●	●	●	●	●
Door mirrors:	Body coloured	●	-	-	●	●
	Gloss Black	-	●	●	-	-
	Electrically adjustable, heated auto power-folding door mirrors	●	●	●	●	●
	with auto-dimming (Drivers mirror only)	●	●	●	●	●
	with memory	○	●	●	●	●
	Selectable tilt-down function when in reverse	○	●	●	●	●
Front Grille:	Gloss black bar	●	-	-	●	●
	Gloss black honeycomb	-	●	●	-	-
Front Signature Wing	Bright finish	●	-	-	●	●
	Dark plating	-	●	●	-	-
Front wing - side garnish:	Bright finish	●	-	-	●	●
	Dark plating	-	●	●	-	-
Headlights:	LED, with auto headlight levelling	●	●	●	●	●
	Signature LED daytime running lights	●	●	●	●	●
	High Beam Control (HBC) - detects oncoming and preceding vehicles and automatically switches between high and low beams during night driving, making it easier for the driver to recognise hazards	●	●	●	●	●
	Dusk-sensing headlights	●	●	●	●	●
	Coming home / leaving home lights	●	●	●	●	●
	Headlight washers	●	●	●	●	●
	Adaptive LED Headlights: Features 4 modes: - Glare-free High Beam - Highway mode - Marking light - Wide-range Low Beam	○	○	●	○	●
Kodo Turn Signal - distinctive light signature that starts at full power and then fades in sequential pulses		●	●	●	●	●
Parking sensors (audible and visual warning):	Front and Rear	●	●	●	●	●
Parking aids:	Reversing camera with dynamic guide lines	●	●	●	●	●
	360° View Monitor (front, rear and side cameras) with see through view and trailer connection support view	○	○	●	○	●
Power liftgate with hands free function		●	●	●	●	●
Privacy glass:	Rear side and rear windows	○	○	●	○	●
Rear lights:	Signature LED rear combination lights	●	●	●	●	●
Roof rails:	Bright	●	●	●	●	●
Sunroof:	Electric panoramic sunroof	-	○	●	○	●
Wheel arch and side sill mouldings	Satin black	●	-	-	-	-
	Body coloured	-	●	●	●	●
Wheels & tyres:	18" Grey alloy wheels with 235/60 R18 tyres	●	-	-	-	-
	20" Silver alloy wheels with 235/50 R20 tyres	○	-	-	-	-
	20" Black alloy wheels with 235/50 R20 tyres	-	●	●	-	-
	20" Grey Diamond Cut alloy wheels with 235/50 R20 tyres	-	-	-	●	●
Wipers:	Front, rain-sensing with adjustable sensitivity and speed	●	●	●	●	●
	Front Wiper De-icer - Hot wires located along the drivers side A-pillar and the wiper finishing positions	●	●	●	●	●
	Low washer fluid warning lamp	●	●	●	●	●

● = Standard equipment, - = Not available, ○ = Optional as part of a pack

# EQUIPMENT

		EXCLUSIVE-LINE	HOMURA	HOMURA PLUS	TAKUMI	TAKUMI PLUS
<b>INTERIOR</b>						
Centre Console Panel	Mesh Metal film	●	-	-	-	-
	Matt Black Hairline film	-	●	●	-	-
	White Maple wood	-	-	-	●	●
Dashboard panel:	Vinyl leather	●	-	-	-	-
	Cordovan-like vinyl leather	-	●	●	-	-
	Woven fabric with Kakenui inspired stitching	-	-	-	●	●
Electronic Parking Brake with auto-hold and auto-disengage function		●	●	●	●	●
Electrical power outlets:	12V outlet (x1 front, x1 luggage compartment)	●	●	●	●	●
	150W AC socket	○	○	●	○	●
	1500W AC socket (PHEV models only)	○	○	●	○	●
Gear shift:	Leather-wrapped	●	●	●	●	●
Grab handles:	Driver, front passenger and two rear, with coat hooks	●	●	●	●	●
Instrument cluster:	Trip computer	●	●	●	●	●
	Colour 12.3-inch TFT display (provides speed, traffic signs and cruise control information)	●	●	●	●	●
Interior mirror:	Frameless auto-dimming rear-view mirror	●	●	●	●	●
Interior trim:	Black leather trim	●	-	-	-	-
	Black Nappa leather trim	-	●	●	-	-
	White Nappa leather trim	-	-	-	●	●
Roof lining:	Grey	●	-	-	●	●
	Black	-	●	●	-	-
Seats (Front):	Driver seat manual tilt, slide, recline and height adjustment	●	-	-	-	-
	Driver seat electric tilt, slide, recline, height and lumbar adjustment	○	●	●	●	●
	Mazda Driver Personalisation System: (seat/ head up display/ wing mirrors)	○	-	-	-	-
	Mazda Driver Personalisation System: (seat/ head up display/ wing mirrors/ steering wheel)	-	●	●	●	●
	Driver seat ingress/ egress support & automatic driver position guide	-	●	●	●	●
	Passenger seat manual slide, recline and height adjustment	●	-	-	-	-
	Passenger seat electric slide, recline, height and lumbar adjustment	○	●	●	●	●
	Heated with 3-stage setting	●	●	●	●	●
Ventilation with 3-stage setting	○	●	●	●	●	
Seats (second row):	60:40 split fold down rear seats (3-seat bench only)	●	●	●	●	●
	Manual slide & recline	●	●	●	●	●
	3-seat bench featuring folding centre armrest equipped with two cup holders	●	●	●	●	●
	2 folding Captains seats with walkthrough	-	○	○	-	-
	2 folding Captains seats featuring seat ventilation with centre console	-	-	-	-	○
	Heated outer rear seats with 3-stage setting	○	●	●	●	●
	One-touch walk-in (3-seat bench only)	○	●	●	●	●
Seats (third row):	Three height-adjustable head restraints	●	●	●	●	●
	2-seat bench	●	●	●	●	●
Steering wheel:	50:50 split fold down rear seats	●	●	●	●	●
	Leather-wrapped	●	●	●	-	-
	Leather-wrapped with light stitching	-	-	-	●	●
	Manual telescopic and tilt adjustment	●	-	-	-	-
	Electric telescopic and tilt adjustment	-	●	●	●	●
	Heated	●	●	●	●	●
Storage spaces:	Paddle shift	●	●	●	●	●
	Cargo net	●	●	●	●	●
	Door pockets (driver, front passenger and two rear)	●	●	●	●	●
	Front centre storage with two cupholders	●	●	●	●	●
	Front centre storage with illumination and two cupholders	○	○	●	○	●
	Glovebox with interior illumination	●	●	●	●	●
	Roof mounted sunglasses holder	●	●	●	●	●
Seatback pocket (located on rear of front driver and passenger seats)		●	●	●	●	●

● = Standard equipment, - = Not available, ○ = Optional as part of a pack

# EQUIPMENT

		EXCLUSIVE-LINE	HOMURA	HOMURA PLUS	TAKUMI	TAKUMI PLUS
<b>INFOTAINMENT</b>						
Amazon Alexa car integration	Amazon Alexa is a cloud-based virtual assistant from Amazon that allows you to play music, create to-do lists, get the latest news or weather information and much more by voice command.	●	●	●	●	●
Integrated Bluetooth®:	Allows audio transfer from Bluetooth® devices, hands-free calling and easy access to phone contacts via steering wheel controls or Multimedia Commander	●	●	●	●	●
Mazda Connect (Multimedia System):	AM / FM / DAB radio, with 8 speakers	●	-	-	-	-
	AM / FM / DAB radio featuring 12-Speaker Bose surround sound system, with Bose CenterPoint, BassMatch and AudioPilot technology.	-	●	●	●	●
	12.3-inch TFT Colour centre display	●	●	●	●	●
	Steering wheel-mounted audio and Bluetooth® controls	●	●	●	●	●
	USB-C inputs (x2 front, x2 second row, x2 third row)	●	●	●	●	●
Mazda Connected Services <sup>1)</sup> :	Connected Services - Accessed via the MyMazda App which provides you with information about your vehicle, you can also access many other features like remote controls, vehicle finder and send a destination to your car	●	●	●	●	●
Mazda Hybrid Navigation System:	European mapping with alternative route calculations, point of interest search and 7-years free map updates	●	●	●	●	●
Multimedia Commander:	Located between the driver and front passenger, the Multimedia Commander allows easy control of the advanced connectivity and infotainment system, with information displayed on the 12.3" colour centre screen, includes a separate volume control dial	●	●	●	●	●
Qi Wireless Charging	The Qi wireless charging tray is located on the central console allowing for wireless charging of your smartphone (where available)	○	○	●	○	●
Wireless Apple CarPlay® & Android Auto™	In-car assistant systems that let you access certain features of your phone through Mazda Connect. Touch-screen functionality when vehicle is stationary	●	●	●	●	●

● = Standard equipment, - = Not available, ○ = Optional as part of a pack

Please visit [mazda.co.uk](http://mazda.co.uk) for more information.

<sup>1)</sup> Connected Services is a subscription service and requires a compatible mobile device to download and sign-up to the MyMazda App. A 7-year complimentary period is included and commences from the date of first registration of the vehicle. Please contact your dealer or visit [www.mazda.co.uk/my-mazda](http://www.mazda.co.uk/my-mazda) for further information.

		EXCLUSIVE-LINE	HOMURA	HOMURA PLUS	TAKUMI	TAKUMI PLUS
<b>COMFORT AND CONVENIENCE</b>						
Climate-controlled air-conditioning:	Three-zone climate control air-conditioning with rear air-vents for 2nd and 3rd row	●	●	●	●	●
Cruise Control with Adjustable Speed Limiter		●	●	●	●	●
Mazda Radar Cruise Control (MRCC) (Features Stop & Go function)		○	○	●	○	●
Cruising & Traffic Support (CTS) with unresponsive driver support:	Where conditions allow, assists driver with accelerator, brake and steering functions when following a vehicle ahead in heavy traffic, helping to reduce driver fatigue. Unresponsive Driver Support activates if the driver fails to respond to vehicle alerts by decelerating to a stop, applying the parking brake, unlocking the doors and sounding the horn.	○	○	●	○	●
Electric windows:	Front & rear with one-touch auto down / up	●	●	●	●	●
Kinematic Posture Control:	Applies a very small amount of brake force to the inner wheel during cornering, the resulting brake force pulls the body down, suppressing body roll to improve cornering.	●	●	●	●	●
Head-up Display:	Windscreen Projected colour Active Driving Display: Projects full-colour information directly onto the windscreen within the driver's line of sight, including navigation, speed and vehicle status.	●	●	●	●	●
Interior Lighting:	Front & rear with LED illumination	●	●	●	●	●
	Top-down centre console illumination with front & rear footwell lighting	●	●	●	●	●
	Door pocket illumination and front & rear door courtesy lamps	○	○	●	○	●
	Ambient lighting	-	●	●	●	●
Luggage compartment:	LED illumination	●	●	●	●	●
Mi-DRIVE:	Normal mode	●	●	●	●	●
	Sport mode	●	●	●	●	●
	Off-road mode	●	●	●	●	●
	Towing mode	●	●	●	●	●
	EV Mode (PHEV models only)	●	●	●	●	●
Power Start / Stop button		●	●	●	●	●
Sunshade:	Fitted to rear doors, the integrated sunshade provides protection from direct sunlight for passengers.	●	●	●	●	●
Sun visors:	Driver's and front passenger's with covered vanity mirror and driver's ticket holder	●	●	●	●	●

● = Standard equipment, - = Not available, ○ = Optional as part of a pack

# EQUIPMENT

		EXCLUSIVE-LINE	HOMURA	HOMURA PLUS	TAKUMI	TAKUMI PLUS
<b>SAFETY AND SECURITY</b>						
Airbags:	Front dual stage driver and single stage front passenger	●	●	●	●	●
	Front and rear side airbags	●	●	●	●	●
	Front central airbag	●	●	●	●	●
	Front and rear curtain airbags	●	●	●	●	●
	Front driver knee airbag	●	●	●	●	●
	Passenger airbag deactivation system (auto switch)	●	●	●	●	●
Anti-lock Braking System (ABS)		●	●	●	●	●
Blind Spot Monitoring (BSM):	with Rear Cross Traffic Alert (RCTA)	●	●	●	●	●
Driver Attention Alert (DAA):	The system monitors driver inputs and the vehicle's movements to sense the early stages of driver fatigue.	●	●	●	●	●
Driver Monitoring (DM):	A camera within the centre display screen monitors the driver's facial movements to detect driver fatigue, encouraging the driver to take a rest where needed.	●	●	●	●	●
Dynamic Stability Control (DSC)		●	●	●	●	●
e-Call with GPS:	In the case of an accident, either provides a manual or automated message to the emergency services, which includes the vehicle's location. (European locations only).	●	●	●	●	●
Emergency Lane-Keeping:	Road Keep Assist - Enhanced camera function to enable the detection of grass and curbs along the roadside to help prevent departure from the road even on roads without lanes. Activates when the CX-80 is traveling at approximately 37mph or above, assisting steering operation when there is a risk that the vehicle may depart from the road	●	●	●	●	●
	Blind Spot Assist - Assists steering operation when changing lanes despite the risk of a potential collision. It detects vehicles approaching from the rear or side of the vehicle when the CX-80 is travelling at approximately 37mph or above.	●	●	●	●	●
	Oncoming vehicle collision avoidance assist - If the vehicle deviates from the lane when running on the road with a white line and determines that it could crash an oncoming vehicle, it will intervene steering without delay and assist lane deviation prevention and crash avoidance	●	●	●	●	●
Emergency Stop Signalling system (ESS)		●	●	●	●	●
Emergency tyre repair kit		●	●	●	●	●
Front Cross Traffic Alert (FCTA):	When pulling out of junctions, the system checks for approaching vehicles in your blind spots either side or the front of your vehicle. When an oncoming vehicle is detected, it sounds a warning and applies the brakes if the system believes a collision may occur.	●	●	●	●	●
Hill Descent Control:	Hill Descent Control supports safe downhill driving on steep slopes with slippery, rough road surfaces such as off-road terrain or snow-covered hills. It does this by automatically keeping the car at a constant speed without the driver needing to operate the brakes.	●	●	●	●	●
Hill Launch Assist (HLA):	When taking off on an incline, helps prevent the car from rolling backwards when the driver moves their foot from the brake to the accelerator pedal.	●	●	●	●	●
Intelligent Speed Assist (ISA):	A driver operated speed-limiting system that works in conjunction with Traffic Sign Recognition (TSR) to help keep drivers from exceeding the speed limit unintentionally.	●	●	●	●	●
ISOFIX child seat anchorage; attached to outer rear seats (2nd row)		●	●	●	●	●
Lane-keep Assist System (LAS) with Lane Departure Warning System (LDWS):	The system detects the line markings on the road surface and instantly warns you in case of unintentional lane departure, whilst also assisting to steer the vehicle to keep it within its lane.	●	●	●	●	●
Occupant sensor (rear seat)		●	●	●	●	●

● = Standard equipment, - = Not available, ○ = Optional as part of a pack

continued >

# EQUIPMENT

SAFETY AND SECURITY <i>continued</i>		EXCLUSIVE-LINE	HOMURA	HOMURA PLUS	TAKUMI	TAKUMI PLUS
Pre-crash safety: Smart Brake Support (SBS):	Front (SBS) - designed to reduce the risk of accidents by helping the driver avoid front-end collisions. The system also features:- - Turn-Across Traffic - designed to reduce the risk of accidents by helping the driver avoid frontal collisions - Head on collision mitigation - if the system determines that the oncoming vehicle may deviate from its lane and collide head-on with your vehicle, the system will intervene by applying early braking in advance to assist in reducing collision damage Rear (SBS-R) - designed to reduce the risk of accidents by helping the driver avoid rear-end collisions Rear Crossing (SBS-RC) - detects vehicles approaching from the rear left and right sides of the vehicle, and the rear of the vehicle while the vehicle is being reversed out of a parking space	●	●	●	●	●
Remote central locking with deadlocking and automatic door lock when driving		●	●	●	●	●
Smart keyless entry:	Allows opening and locking of the vehicle without removing the key from your pocket or bag	●	●	●	●	●
Seatbelt reminder audible warning:	Driver, passenger and rear seats	●	●	●	●	●
Thatcham accredited alarm and immobiliser		●	●	●	●	●
Traffic Sign Recognition (TSR) with intelligent speed assist	Utilising the front sensing camera and Navigation data, this system is designed to notify the driver of traffic signs by displaying them on the instrument panel and the head-up display. If the vehicle exceeds the recognised speed limit, an audible tone will be activated	●	●	●	●	●
Tyre Pressure Monitoring System (TPMS)		●	●	●	●	●
Trailer Stability Control (TSC):	TSC is a system that increases the stability of the vehicle during towing. When vehicle sway occurs during towing, the TSC controls the output of the brakes and the engine to suppress swaying	●	●	●	●	●
Vehicle exit warning:	Assists the driver in checking the rear of the vehicle when exiting the vehicle. When a vehicle or bicycle approaching from the rear is detected, various screen displays and warning sounds notify the driver of the danger	●	●	●	●	●

● = Standard equipment, - = Not available, ○ = Optional as part of a pack

ELECTRIFICATION (PHEV MODELS ONLY)	EXCLUSIVE-LINE	HOMURA	HOMURA PLUS	TAKUMI	TAKUMI PLUS
Type 2 Mode 2 cable for AC charging via UK 3-pin plug	●	●	●	●	●
Type 2 Mode 3 cable for AC charging via home or public charge points	●	●	●	●	●

● = Standard equipment, - = Not available, ○ = Optional as part of a pack

# TECHNICAL INFORMATION

## Model Availability

	2.5 e-SKYACTIV PHEV AWD 327ps Automatic	3.3 e-SKYACTIV D MHEV AWD 254ps Automatic
Exclusive-Line	●	●
Homura	●	●
Homura Plus	●	●
Takumi	●	●
Takumi Plus	●	●

## Dimensions

	2.5 e-SKYACTIV PHEV AWD 327ps Automatic	3.3 e-SKYACTIV D MHEV AWD 254ps Automatic
Overall length / width <sup>1)</sup> / height (mm) <sup>2)</sup>	4995 / 1890 (2134) / 1710	
Wheelbase (mm)	3120	
Ground clearance between the axles (mm) - unladen <sup>3)</sup>	170	175 (170)
Front track / Rear track (mm)	1640 / 1645	
Front headroom <sup>3)</sup> / leg room / shoulder room (mm)	1101 (998) / 1058 / 1504	
Second row headroom <sup>3)</sup> / leg room / shoulder room (mm)	996 (974) / 998 / 1476	
Third row headroom <sup>3)</sup> / leg room / shoulder room (mm)	915 / 736 / 1296	
Cargo volume, acc. to VDA (l) <sup>3)</sup> :	6/7-seat mode to belt line including underfloor storage	258
	4/5-seat mode to belt line including underfloor storage	566 - 687*
	2-seat mode to ceiling including underfloor storage	1971
Brake Type - Front & Rear	Ventilated Discs	
Brake Dimensions - Front / Rear (mm)	347 / 350	347 / 328

## Steering

Steering gear	Electric Power Assist Steering (Rack and Pinion)
Wall to Wall turning circle (M)	12.4

\*2nd row seating has the ability to side and recline. The higher figure represents middle row seating at its forward-most position.

<sup>1)</sup> Vehicle width excludes mirrors. Figures in brackets includes mirrors opened

<sup>2)</sup> Values include driver at 75kg, height includes roof rails.

<sup>3)</sup> Figures in brackets are for vehicles fitted with panoramic sunroof.



3120 mm

4995 mm



2134 mm

1710 mm



2134 mm

1710 mm

# TECHNICAL INFORMATION

		2.5 e-SKYACTIV PHEV AWD 327ps Automatic	3.3 e-SKYACTIV D MHEV AWD 254ps Automatic
Displacement (cc)		2488	3283
Bore x Stroke (mm)		89.0 x 100.0	86.0 x 94.2
Number of cylinders		4	6
Compression ratio		13:1	15.2:1
Transmission		8-Speed Automatic	8-Speed Automatic
<b>Fuel Saving Technology</b>			
i-stop system		●	●
Mazda M Hybrid Boost 48-volt battery		-	●
Plug-in Hybrid System (PHEV)		●	-
<b>Electrification</b>			
Battery Size		17.8kWh	0.3kWh
Battery Type		Lithium-ion	Lithium-ion
Battery Weight (kg)		177.5	15
Battery Voltage (V)		355	44.4
<b>Performance</b>			
Maximum power output	Total ps (KW) / rpm	327 (241) / 6,000	254 (187) / 3,750
	Electric Motor	129kW	12.4kW
Max. torque (Nm / rpm)		500 / 4,000	550 / 1,500-2,400
Acceleration (0-62 mph in seconds)		6.8	8.4
Top Speed (mph)		121	136
<b>Fuel Economy and CO<sub>2</sub> Emissions</b>			
WLTP fuel consumption mpg (l/100km) <sup>1)</sup>	Low	28.0 (10.1)	41.5 (6.8) - 42.2 (6.7)
	Medium	36.7 (7.7)	50.4 (5.6) - 51.4 (5.5)
	High	39.8 (7.1)	56.5 (5.0) - 57.6 (4.9)
	Extra High	33.2 (8.5) - 33.6 (8.4)	45.6 (6.2) - 46.3 (6.1)
	Combined	34.9 (8.1)	48.7 (5.8) - 49.6 (5.7)
weighted combined*		166.2 (1.7) - 176.6 (1.6)	-
Equivalent all-electric range <sup>1)</sup>		38 miles	-
WLTP electric energy consumption (miles/kWh) (weighted combined) <sup>1)</sup>		2.6	-
WLTP CO <sub>2</sub> emissions (g/km) <sup>1)</sup>	weighted combined*	35 - 38	-
	combined	-	148 - 151
EC emission level		Euro Stage 6e	Euro Stage 6e
Recommended fuel		Unleaded 95 RON	Diesel
Fuel tank capacity (litres)		70	74
AdBlue® - Selective Catalytic Reduction (SCR system) is designed to purify and reduce nitrogen oxide (NOx) in the exhaust gas, by injecting it with AdBlue®		-	●
AdBlue® tank capacity (litres)		-	6.7
<b>Charging</b>			
Domestic Socket 2.4kW (20-80%)		4 hours, 50 minutes	-
Domestic Socket 2.4kW (0-100%)		7 hours, 50 minutes	-
Mode 3 AC Charging (20-80%)		1 hour, 30 minutes	-
Mode 3 AC Charging (0-100%)		2 hours, 20 minutes	-
<b>Weights</b>			
Minimum Kerb weight (kg) excl. driver		2,165 / 2,216	2,061 / 2,120
Maximum Kerb weight (kg) incl. driver (75kg)		2,290 / 2,314	2,152 / 2,211
Permitted gross vehicle weight (kg)	Total	2,889	2,781
	Front/rear	1,249 / 1,640	1,267 / 1,514
Towing limit <sup>2)</sup> (kg):		2500	2500
Maximum roof load (kg)		100	100

\* These figures were obtained using a combination of battery power and fuel. The Mazda CX-80 is a plug-in hybrid vehicle requiring mains electricity for charging.

<sup>1)</sup> Figures shown are for comparability purposes; only compare fuel consumption and CO<sub>2</sub> figures with other cars tested to the same technical procedures. These figures may not reflect real life driving results, which will depend upon a number of factors including the accessories fitted (post-registration), variations in weather, driving styles and vehicle load. All figures quoted are derived from the latest WLTP test cycle.

<sup>2)</sup> Towing capacity is based on a 12% gradient and tested in accordance with 92/21/EEC as amended by 95/48/EC

## THE LATEST IN TECHNOLOGY & CONVENIENCE

### e-SKYACTIV PHEV – PLUG-IN HYBRID ELECTRIC VEHICLE

In order to achieve better environmental performance without compromising on the intuitive driving you come to expect from a Mazda, we developed the Mazda CX-80 Plug-in Hybrid. Ideal for those drivers who want to transition into the EV lifestyle.

This e-Skyactiv Plug-in Hybrid SUV is equipped with a naturally aspirated four-cylinder 2.5-litre engine, coupled with a 129KW electric motor and a 355V, 17.8kWh high-capacity lithium-ion battery. This combination of engine and motor delivers a total system output of 327ps and 500Nm of torque.

The Mazda CX-80 PHEV also displays outstanding environmental credentials with the ability to drive up to 38 miles of electric motor-powered driving, meaning that the vehicle will use no petrol and produce 0g/km of CO<sub>2</sub>. Using a combination of both petrol and electric driving, the Mazda CX-80 provides WLTP weighted combined fuel consumption of up to 176.6mpg, and WLTP weighted combined CO<sub>2</sub> emissions of only 35-38g/km.

#### CHARGING OVERVIEW

##### What you need to know...

- The Mazda CX-80 is compatible with the most common charging connectors (Type2) for both at home and out-of-home charging, via AC.
- Charging cables and power sockets are completely waterproof so can be used at any time to charge your Mazda CX-80.
- The sockets lock into the car, meaning it is secure and safe to leave unattended.
- A Type 2 Mode 2 cable for AC charging via a UK 3-pin plug and a Type 2 Mode 3 cable for AC charging via home or public charge points are both included with the car.



\*Figures shown are for comparability purposes; only compare fuel/energy consumption and CO<sub>2</sub> figures with other cars tested to the same technical procedures. These figures may not reflect real life driving results, which will depend upon a number of factors including the starting charge of the battery, accessories fitted (post-registration), variations in weather, driving styles and vehicle load, and use of features such as air conditioning or heated seats. All figures quoted are derived from the latest WLTP test cycle.

## e-SKYACTIV D MHEV – MILD HYBRID ELECTRIC VEHICLE

For those who frequently drive long distances or need to regularly tow heavy loads, we have developed the latest in Diesel engine technology.

Our 3.3-litre in-line six-cylinder e-Skyactiv D diesel engine features Distribution-Controlled Partially Premixed Compression Ignition (DCPCI) Technology. This highly innovative advanced combustion technology makes the new e-Skyactiv D one of the cleanest diesel engines in the world.



Developed using our 'right sizing' concept which optimises displacement to improve both fuel and power efficiency, the all-new direct injection inline six-cylinder e-Skyactiv D provides 254ps with Mazda i-Activ AWD (all-wheel drive) providing 550Nm of torque.

Our Diesel powertrain features a 48v Mazda M Hybrid Boost system. Our innovative evolution of mild hybrid vehicle technology uses three main components to capture energy that is normally wasted during braking. It stores that energy within the 48v Lithium-ion Battery and uses it to assist the engine and power the car's electrical systems, meaning you can drive further on a tank of fuel whilst also contributing to lower CO<sub>2</sub> emissions and other particulates.

## SKYACTIV-VEHICLE DYNAMICS: TRANSMISSIONS, CHASSIS AND DYNAMICS



### TRANSMISSIONS

Mazda's eight-speed automatic transmission is designed to offer drivers a smooth and responsive gear shift with slick steps between ratios, achieving the right balance between driver engagement, comfort, dynamic performance and environmental efficiency.

The new transmission replaces the torque converter with a clutch, so that the torque of the engine and the electric motor is transmitted directly, with a similar fast shifting feel akin to a manual transmission.



### SKYACTIV-CHASSIS

Providing a lightweight chassis that delivers driving pleasure and comfort, leading to that pure 'Jinba-ittai' oneness between car and driver.

The perfectly fine-tuned chassis provides our famed driving experience of agility at low and medium speeds, and stability at motorway speeds for both driving pleasure and comfort.



### DYNAMICS

In order to offer a driving experience that makes it possible for drivers to control a more powerful car and enjoy an exciting driving feel, the Mazda CX-80 uses Skyactiv Multi-Solution Scalable Architecture, our new vehicle architecture technology that's compatible with a longitudinal engine and rear-wheel-drive layout.

Skyactiv Multi-Solution Scalable Architecture features numerous enhancements that improve that Jinba-Ittai driving feeling, such as rigidity that ensures drivers can feel vehicle response without lag, seats that make it even easier for everyone in the car to maintain balance while the car is moving, and suspension that stabilises vehicle posture while driving. As a result, the Mazda CX-80 makes it possible for drivers to enjoy a truly great drive.

# ADVANCED SAFETY TECHNOLOGY



## DRIVER MONITORING

Detects sleepiness or inattention by monitoring changes in expression or movement of the driver's line of sight. A camera and infrared LED monitor the driver's condition both day and night. If the system determines that the driver has fallen asleep or is inattentive, it sounds an alert to make the driver aware while also setting up for automatic braking to help prepare for a potential incident.

(Standard across the range)



## COLOUR ACTIVE DRIVING DISPLAY (HEAD-UP DISPLAY)

The system projects full-colour information directly onto the windscreen within the driver's line of sight. The displayed information includes Traffic Sign Recognition, Mazda navigation turn-by-turn directions, as well as vehicle status including current speed and advanced safety equipment status.

(Standard across the range)



## MAZDA DRIVER PERSONALISATION SYSTEM

The Mazda Driver Personalisation System recognises the driver using the camera inside the vehicle, and automatically restores various driver settings that have been stored. This includes a function that automatically adjusts the driver's seat, Active Driving Display, outer mirror angle and steering wheel position based on the driver's physique. The system will also move the seat and the steering wheel so that the driver can easily enter and exit the vehicle.

(Optional as part of Comfort Pack on Exclusive-Line (excludes steering wheel function & Ingress/Egress support), standard on Homura, Homura Plus, Takumi & Takumi Plus)

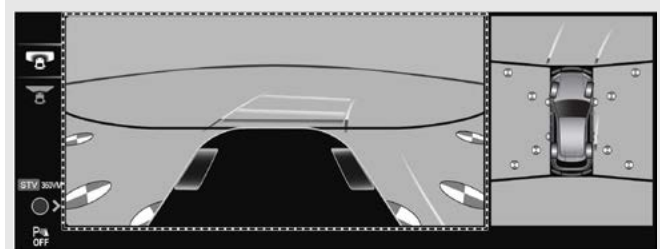

## 360° VIEW MONITOR WITH SEE-THROUGH VIEW

Displays a 360° image using front, side and rear cameras with guide lines to assist in checking the area at the front, rear and sides of the vehicle when driving forward, parking or stopping. See-Through View provides a display of the front or rear of the vehicle as though it was transparent.

(Optional as part of Convenience & Driver Assistance Pack on Exclusive-Line, Homura & Takumi. Standard on Homura Plus and Takumi Plus)

# ADVANCED SAFETY TECHNOLOGY

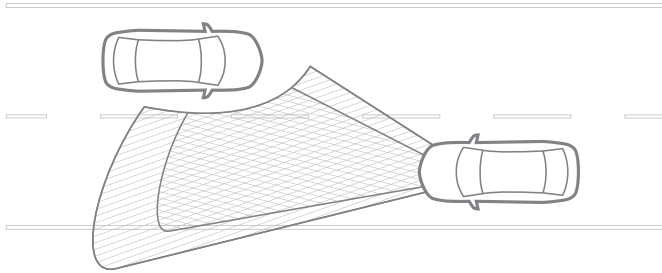

## ADAPTIVE LED HEADLIGHTS

Mazda's Adaptive LED Headlights provide the ultimate in headlight technology, lighting up the road ahead as if it were daytime and allowing anybody to enjoy safe and stress-free driving at any time. The system increases visibility at night to help drivers stay vigilant by combining four technologies: Wide-range Low Beams which light up a wider area at low speeds, Marking light which brightly illuminates pedestrians that may collide with the vehicle, Highway mode which helps you see further when travelling at speed, and Glare-free High Beams which automatically dim part of the illuminated area to avoid dazzling other drivers.

(Optional as part of Convenience & Driver Assistance Pack on Exclusive-Line, Homura & Takumi. Standard on Homura Plus and Takumi Plus)

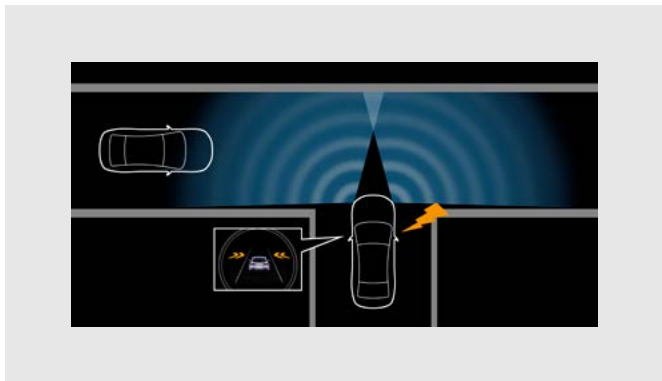

## FRONT CROSS TRAFFIC ALERT

Mazda's newly developed system detects other vehicles approaching from blind spots at the front right or left of the vehicle, and alerts the driver of their presence. If the driver depresses the accelerator and the system detects an oncoming vehicle, it will operate the brakes to stop or reduce the chance of a collision. This helps prevent a common cause of accidents when cars enter a T-junction with a partially obscured view.

(Standard across the range)

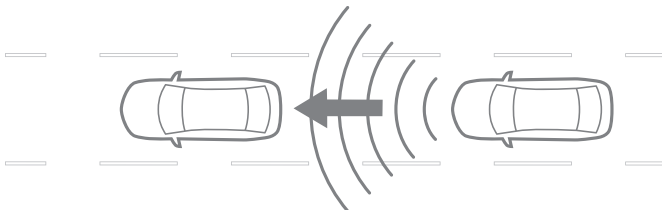

## MAZDA RADAR CRUISE CONTROL

To activate, the driver sets a maximum speed (just as with cruise control) and size of the gap to maintain. The radar watches for traffic ahead and once the system senses a vehicle in front, the car will slow down and speed up automatically maintaining the drivers pre-set distance. The system also features 'Stop & Go' function, meaning the vehicle will automatically accelerate and brake in start/stop traffic with minimal input from the driver.

(Optional as part of Convenience & Driver Assistance Pack on Exclusive-Line, Homura & Takumi. Standard on Homura Plus and Takumi Plus)

# ADVANCED SAFETY TECHNOLOGY

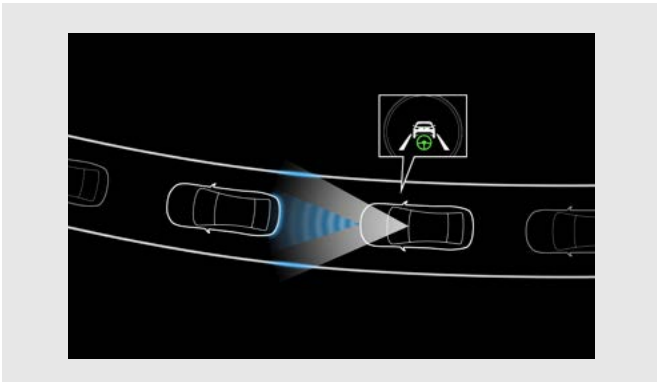

## CRUISING & TRAFFIC SUPPORT (CTS) WITH UNRESPONSIVE DRIVER SUPPORT

Automatically operates acceleration and braking to maintain a proper trailing distance between your Mazda and the vehicle ahead. In addition, it assists with steering operations to keep the car within its lane. CTS contributes to reducing driver fatigue, as well as supporting a safer, more reassuring and more comfortable driving experience.

Operating only when CTS is on, Unresponsive Driver Support activates if the driver does not operate the steering for a certain period of time. It then alerts the driver with escalating warning levels. If the driver still fails to respond and resume driving normally, the system will decelerate to a stop to mitigate damage, applying the parking brake, unlocking the doors and sounding the horn.

(Optional as part of Convenience & Driver Assistance Pack on Exclusive-Line, Homura & Takumi. Standard on Homura Plus and Takumi Plus)

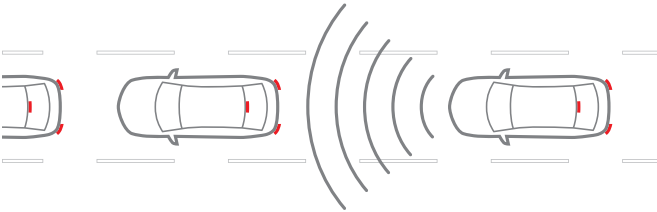

## SMART BRAKE SUPPORT – FRONT WITH TURN-ACROSS TRAFFIC

SBS alerts the driver of a possible collision using the warning indications in the display, and a warning sound if the front radar sensor and Forward Sensing Camera determine that there is the possibility of a collision with a vehicle, pedestrian, or a bicycle ahead. Furthermore, if a collision is unavoidable, the automatic brake control is performed to reduce damage in the event of a collision. In addition, when the driver depresses the brake pedal, the brakes are applied firmly and quickly to assist.

The Turn-Across Traffic function is designed to assist the driver in avoiding a collision (or reducing the impact) with a vehicle approaching in the opposite direction when making a turn at a junction.

(Standard across the range)

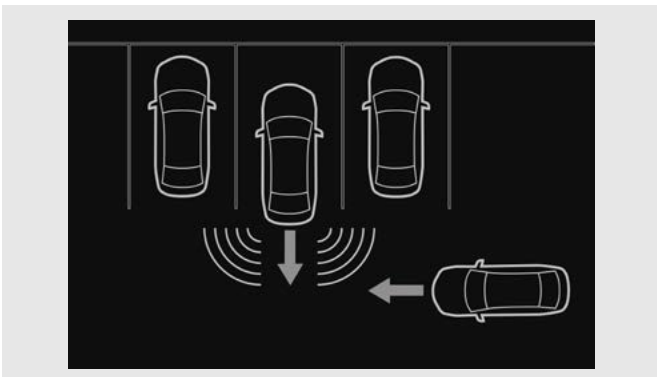

## SMART BRAKE SUPPORT – REAR

Reduces damage in the event of a collision by operating the brake control when the system's sensors detect an obstruction at the rear.

## SMART BRAKE SUPPORT – REAR CROSSING

Assists in avoiding collisions and reducing damage whilst the vehicle is in reverse. If there is the possibility of an impact with a vehicle approaching from the rear, the system will apply the brakes.

(Standard across the range)

# ADVANCED SAFETY TECHNOLOGY

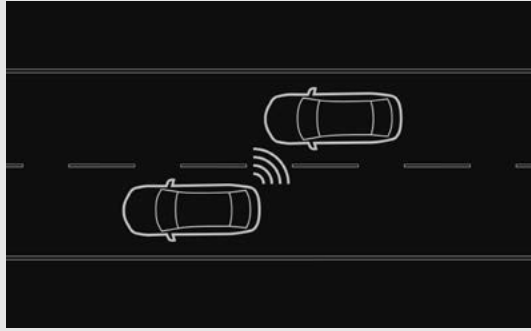

## BLIND SPOT MONITORING (BSM) WITH REAR CROSS TRAFFIC ALERT (RCTA)

BSM uses radars mounted in the rear bumper to detect vehicles approaching from behind and in the adjacent lane. It alerts the driver to the presence of vehicles in the blind spot on either side by displaying an icon in the appropriate door mirror. If the driver indicates to change lanes with a vehicle in the blind spot, the icon flashes and a warning beep is sounded.

RCTA is designed to help you make sure it's safe to start backing up. The system uses the same radars and indicators as BSM to watch for vehicles coming from both sides, and alerts the driver when they come near.

(Standard across the range)

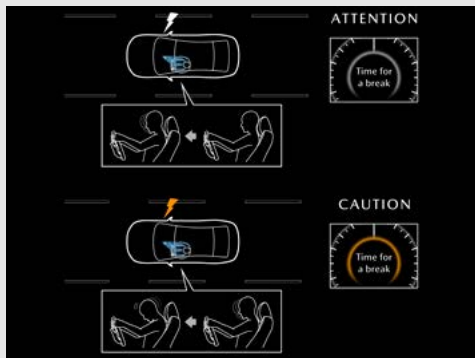

## DRIVER ATTENTION ALERT

Designed to reduce accidents caused by inattentiveness due to driver fatigue. The system comes into play at speeds above 41mph and begins to "learn" the driver's habits, watching inputs and the vehicle's movements in the early stages before fatigue is a factor. Later, if the system detects changes in vehicle behaviour that suggest the driver may be losing concentration, it will suggest a rest stop by sounding a chime and displaying a warning in the Multi-Information Display.

(Standard across the range)

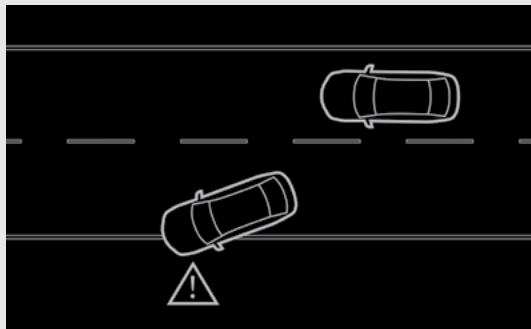

## LANE-KEEP ASSIST SYSTEM WITH LANE DEPARTURE WARNING SYSTEM

Designed to prevent your vehicle from inadvertently straying from its lane. A front view camera monitors the road ahead and calculates the car's position relative to the lane markings. If the system detects the vehicle is moving out of its lane unintentionally, the steering wheel will vibrate and an audible alert will sound. The system will also take corrective action to help you stay within the lanes through assisted steering.

(Standard across the range)

# VEHICLE TAX RATES

## VEHICLE TAX RATES TAX YEAR 2026-27

CO <sub>2</sub> EMISSIONS FIGURE (G/KM)	ALL CARS FIRST YEAR RATE	ALL CARS STANDARD RATE (12 months)
0	£10	£200
1-50	£115	£200
51-75	£135	£200
76-90	£280	£200
91-100	£365	£200
101-110	£405	£200
111-130	£455	£200
131-150	£560	£200
151-170	£1,410	£200
171-190	£2,270	£200
191-225	£3,420	£200
226-255	£4,850	£200
Over 255	£5,690	£200

First-year rate is paid when first registering a vehicle and is for the first 12 months Vehicle Excise Duty. After the first 12 months, the standard rate applicable at that time is payable. Petrol/diesel/alternative fuel cars with a list price >£40k will be subject to a premium of £440 over the Standard Rate for 5 years from the start of the second licence.

## WARRANTY

All Mazda cars registered from 1st September 2025 will benefit from a six-year manufacturer's warranty, or 100,000 miles, whichever comes first.

**6** YEAR | MAZDA  
WARRANTY

### e-SKYACTIV PHEV BATTERY WARRANTY

MODEL	WARRANTY PERIOD
e-SKYACTIV PHEV	8-year / 100,000 mile warranty

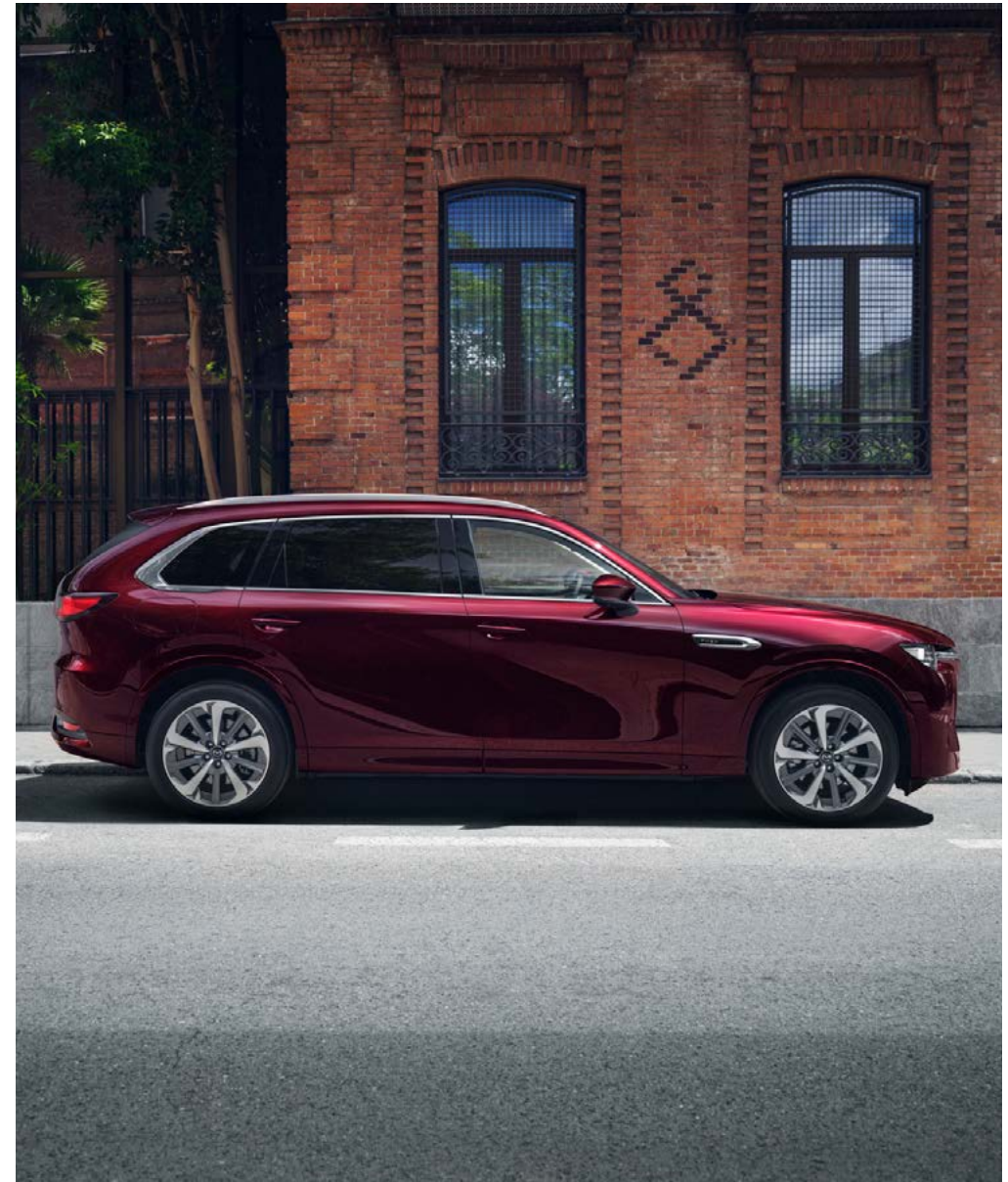

# MAZDA SERVICES

The maximum service interval for your Mazda is 12,500 miles or 12 months whichever occurs first, however, the servicing intervals may reduce based on the style of driving and the conditions under which your vehicle is operated.



## MAZDA FINANCIAL SERVICES

Mazda Financial Services offers a variety of finance and insurance products to suit the needs of both private and business customers. With our wide range of plans and services, no-one is more committed to delivering complete motoring confidence and total peace of mind than Mazda and Mazda Financial Services.†



## MAZDA CAR INSURANCE

Mazda Car Insurance is a fully comprehensive monthly subscription policy with no hidden fees – change your details, renew or cancel, without any charges. You can set up and manage your policy online anytime, anywhere. In just a few clicks, changes are applied immediately, meaning no waiting for paperwork, estimates or call centres. Plus, your price is guaranteed for 12 months if everything stays the same.

Enjoy benefits such as the use of a Mazda Approved Accident Repair Centre, Mazda Genuine Parts, a courtesy car, uninsured driver cover, UK accident recovery, and more.

Find out more at [www.mazdamotorinsurance.co.uk](http://www.mazdamotorinsurance.co.uk)

Mazda Car Insurance is arranged and administered by Wrisk Transfer Limited, registered in England and Wales No. 10657213 at 45 Gresham Street, London, EC2V 7BG and authorised and regulated by the Financial Conduct Authority, Firm Reference No. 788062. Please read the policy wording for full terms, conditions, exclusions and excesses.



## FREE MAZDA ACCIDENT AFTERCARE

In the event of an accident, Call Mazda First 0800 015 0367 before your insurer for free 24-hour Accident AfterCare and to redeem your £250 Excess Return voucher. Our dedicated case handlers will liaise with your insurer and arrange Mazda Genuine Parts and repairs at a Mazda Approved Bodyshop, keeping your Mazda 100% Mazda and maintaining your Mazda warranties. We'll also provide accident recovery if your Mazda isn't driveable and a free courtesy car during the repair. Terms and conditions apply.

Save 0800 015 0367 to your mobile phone.

### TAX FREE – DIPLOMATIC AND MILITARY SALES

For further information contact your Mazda dealer or contact Mazda on 03457 48 48 48.

### MOTABILITY

For all Motability enquiries please contact your Mazda dealer or contact Mazda on 03457 48 48 48.



## MAZDA DRIVEAWAY INSURANCE

Benefit from up to 5 days free cover when you buy a new or used Mazda from an authorised Mazda Dealer - you'll also get a quote for Mazda Car Insurance.

Find out more at [www.mazdamotorinsurance.co.uk/driveaway](http://www.mazdamotorinsurance.co.uk/driveaway)

This price list, dated 1 April 2026, supersedes all previous price lists. It includes changes to Vehicle Excise Duty as confirmed in the Autumn 2025 budget affecting recommended 'On the Road' prices. Final prices shown are recommended 'On the Road' prices and are inclusive of number plates, 12 months' Vehicle Excise Duty and first registration fee. Certain models may be subject to changes in CO<sub>2</sub> emission levels and Vehicle Excise Duty Bands. Due to ongoing updates the specification (including fuel consumption, CO<sub>2</sub> emissions and equipment) of the vehicle you order and receive may be different to that detailed in this guide. Please speak to your dealer for the latest information. Images may not be to UK specification. †Subject to status to over 18s. Indemnities may be required. Terms apply. Mazda Financial Services.

# STAY IN TOUCH WITH MAZDA CX-80

Visit our website and use the Configurator to create your perfect version of the Mazda CX-80.



**BUILD YOUR MAZDA CX-80**

Or get answers to all your questions by requesting more information here.



FIND A DEALER



REQUEST A TEST DRIVE



REQUEST A QUOTE



FOLLOW US ON



# CRAFTED WITH JAPANESE SOUL

APRIL 2026

Mazda Motors UK reserves the right to introduce changes in specification and equipment due to its ongoing product development. Prices are subject to change without prior notice. Colour and trim samples shown in this digital brochure may vary from the actual colours because of the variations of resolutions and colours found in various screen displays, and if printed, limitations within the printing process. Models shown may not be to UK specification. It is recommended that you consult your Mazda dealer when referring to these. Apple CarPlay®, Android Auto™ and Bose are registered trademarks in the U.S. and other countries. Used with permission. Amazon, Alexa, and other related marks are trademarks of Amazon.com, Inc. or its affiliates. The Bluetooth® word mark and logos are owned by the Bluetooth SIG, Inc. and any use of such marks by Mazda Motor Company is under licence. Other trademarks and trade names are those of their respective owners.

Amazon Alexa is a cloud-based voice service provided by Amazon, which is provided under Amazon's own responsibility. To use Alexa, you need an Amazon account. Mazda only enables the use of Amazon Alexa in selected Mazda models and is not responsible for providing the Alexa services. Amazon's terms of use and privacy policy apply.

To use the Alexa functions in your Mazda vehicle, you must also register with Mazda Connected Services via the MyMazda app. For more information about Mazda Connected Services and the processing of data in this context, please refer to [www.mazda.eu/en/mazda-in-europe](http://www.mazda.eu/en/mazda-in-europe). Alternatively, Alexa can be used by connecting the vehicle to a mobile WiFi hotspot. This may incur additional costs depending on your mobile phone tariff.

Amazon, Alexa, and other related marks are trademarks of Amazon.com, Inc. or its affiliates. Amazon Alexa is currently available in English, German, French, Italian, and Spanish. The Mazda Connect system language and home region setting must be set to a language and country supported by Amazon Alexa. In Europe these countries currently are the following: Germany, France, Ireland, Italy, Austria, Spain, United Kingdom.